

konuşulan
the spoken kalite...
quality...

www.akko.com.tr

€ **Fiyat Listesi**
2021



[f](https://www.facebook.com/akko.com.tr) [i](https://www.instagram.com/akko.com.tr) [y](https://www.youtube.com/akko.com.tr) [in](https://www.linkedin.com/akko.com.tr) /akko.com.tr

Yenilikler için bizi takip edin !

 **AKKO®**



TS EN ISO 9001:2015









1986 yılında Abdullah KARAKUŞ tarafından kurulan AKKO Oto. Mak. Hird. San. Tic. Ltd. Şti. Tornalama Takımları, Diş ve Kanal Açma Takımları, Delik Delme Takımları, Frezeleme Takımları ve Özel Takımları üretmektedir. Şu an 8000 m²' ye yakın bir alanda Türkiye, Japonya, Almanya, İsviçre gibi ülkelerin ürettikleri son teknoloji tezgah ve ekipmanlarıyla yıllık 500.000 adet üretim kapasitesiyle, standart 8000 çeşit takım üretimi yapmaktadır. Avrupa, Asya, Afrika, Güney Amerika ve Orta Doğu'da şimdilik 75 ülkeye ürün sevkiyatına devam etmekte olup 300.000 adet civarında üretilmiş ürün stoklarında mevcuttur. Firmaya, özel üretilen çelik ham madde işleme girer ve bütün üretim süreci bünyesinde gerçekleşir. Çeliğin işlenmesi, ısıl işlemi, üzerindeki kaplama ve her türlü üretim süreci bir entegre tesis olan AKKO'da gerçekleşir.

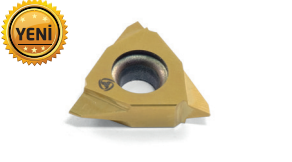

We as AKKO Oto. Mak. Hird. San. Tic. Ltd. Şti, which has been founded by Abdullah KARAKUŞ in 1986, produce Turning Tool Holders, Threading and Grooving Tool Holders, U-Drills, Milling Tool Holders and Precision Tool Holders (OEM Tool Holders). We produce standard 8000 kinds of tool holders with production capacity of 500.000 pieces per annum in an area about 8000 square meter. We are going on exporting 75 countries including European, Asian, African, Asian, South American Countries and Middle East Countries. We keep ready about 300.000 pieces produced products in our stock. Steel Raw materials that we make produced especially for us are delivered our factory and all production process are made in our factory. All kind of process from machining of steel to heat treatment and coating on our tools are made in our integrated factory AKKO.

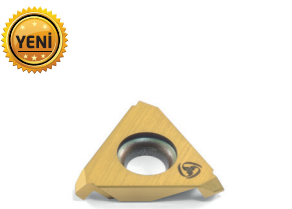

Die Fa. Akko wurde 1986 von Abdullah Karakuş gegründet und produziert Dreh-, Gewinde- und Stechwerkzeuge für Wendeschneidplatten. Ebenso gehören Wendeplattenbohrer, Wendeplattenfräser und Sonderwerkzeuge für Wendeplatten zum Lieferprogramm. Alle Werkzeuge sind auch als OEM-Version lieferbar. Wir fertigen 8000 verschiedene Standardartikel auf einer Fläche von 8000 Quadratmetern. Unsere jährliche Produktionsmenge beträgt ca. 500000 Stück. Wir exportieren in 75 verschiedene Länder in Europa, Asien, Afrika, Südamerika und Mittlerer Osten. Unsere Lagerkapazität beträgt ca. 300000 Stück. Das eingesetzte Rohmaterial wird speziell für unsere Firma produziert. Alle weiteren Produktionsschritte wie z.B. mechanische Bearbeitung, Wärmebehandlung und Beschichtung unserer Werkzeuge erfolgen auf unseren eigenen Maschinenanlagen.

POLY-V KANAL AÇMA UÇLARI ve TAKIMLARI		FİYATI	
	ADKT-T12P-R / L	ADKT-T12P-R/L-1616-T5	30,50 €
	T12...	ADKT-T12P-R/L-2020-T5	31,50 €
		ADKT-T12P-R/L-2525-T5	33,00 €
		ADKT-T12P-R/L-3232-T5	39,20 €
	T12.10.0234.PJ.R		23,60 €
	T12.10.0356.PK.R		25,30 €
	T12.10.0470.PL.R		27,30 €
	ATPVK	ATPVK 2020 K2.34X4	47,30 €
	B26.07.0234PJ.x4 B26.07.0356PK.x4 B26.07.0470PL.x3	ATPVK 2525 M2.34X4	47,70 €
		ATPVK 3232 P2.34X4	55,00 €
		ATPVK 2020 K3.56X4	47,30 €
		ATPVK 2525 M3.56X4	47,70 €
		ATPVK 3232 P3.56X4	55,00 €
		ATPVK 2020 K4.7X3	43,00 €
		ATPVK 2525 M4.7X3	43,40 €
		ATPVK 3232 P4.7X3	50,00 €
	B26.07.0234.PJx4		36,00 €
	B26.07.0356.PKx4		36,00 €
	B26.07.0470.PLx3		33,00 €

KANAL AÇMA, KÖŞE BOŞALTMA UÇLARI ve TAKIMLARI		FİYATI	
	AAUT-T20-R / L	AAUT-T20-R/L-1616-45	26,50 €
	T20...	AAUT-T20-R/L-2020-45	27,50 €
		AAUT-T20-R/L-2525-45	29,00 €
	T20.00.0815.45.04R/L		26,60 €
	T20.00.1220.45.05R/L		26,60 €
	T20.00.2024.45.06R/L		26,60 €
	T20.00.1220.45.10R/L		33,30 €

BROŞ ÇEKME UÇLARI ve TAKIMLARI		FİYATI
 <p>YENİ</p> <p>ABT</p> <p>B41...</p> <p>B42...</p>	ABT-B41-D17-Y25-L90-I040	53,30 €
	ABT-B41-D17-Y25-L105-I065	53,30 €
	ABT-B41-D22-Y25-L100-I050	58,60 €
	ABT-B41-D22-Y25-L125-I070	58,60 €
	ABT-B42-D30-Y32-L100-I050	70,90 €
	ABT-B42-D30-Y32-L125-I075	70,90 €
	ABT-B42-D30-Y32-L170-I110	96,40 €
	ABT-B42-D38-Y32-L100-I050	78,00 €
	ABT-B42-D38-Y32-L125-I075	78,00 €
	ABT-B42-D40-Y32-L100-I050	78,00 €
	ABT-B42-D40-Y32-L125-I075	78,00 €
	 <p>YENİ</p>	B41.00.0612.085.VP3001
B41.00.0713.085.VP3001		20,00 €
B41.00.0813.105.VP3001		20,00 €
B42.00.1013.105.VP3001		25,00 €
B42.00.1215.135.VP3001		25,00 €
B42.00.1215.175.VP3001		25,00 €
B42.00.1215.225.VP3001		25,00 €
B41.00.0498.020.VP3001		20,00 €
B41.00.0598.020.VP3001		20,00 €
B41.00.0798.020.VP3001		20,00 €
B42.00.0998.030.VP3001		25,00 €
B42.00.1197.030.VP3001		25,00 €
B42.00.1397.030.VP3001		25,00 €
B41.00.0501.020.VP3001		20,00 €
B41.00.0601.020.VP3001		20,00 €
B41.00.0801.020.VP3001		20,00 €
B42.00.1001.030.VP3001		25,00 €
B42.00.1200.050.VP3001		25,00 €
B42.00.1201.030.VP3001	25,00 €	
B42.00.1401.030.VP3001	25,00 €	
 <p>YENİ</p>	B41.00.0150.CH.VP3001	20,00 €
	B41.00.0300.CH.VP3001	20,00 €
	B42.00.0600.CH.VP3001	25,00 €

SUPAP YUVASI İŞLEME UÇLARI ve TAKIMLARI			FİYATI
	VST	VST-B11-2842	-
	B11...	VST-B11-4058	-
	VST	VST-B11-1830	-
	B11...		
	VST	VST-B11-2032	-
	B11...	VST-B11-2434	-
	B11013		-
	B11001		-
	B11002		-
	B11003		-
	B11004		-
	B11005		-
	B11006		-
	B11007		-
	B11008		-
	B11009		-
	B11010		-
	B11011		-
	B11012		-
	B11014		-
	B11016		-
	B11017		-
	B11018		-
	B11019		-
	B11020		-
	B11021		-
	B11022		-
B11029		-	
B11030		-	
B11031		-	
B11032		-	
B11033		-	
B11034		-	
B11035		-	
B11036		-	
B11037		-	

SUPAP YUVASI İŞLEME UÇLARI ve TAKIMLARI



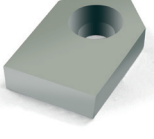

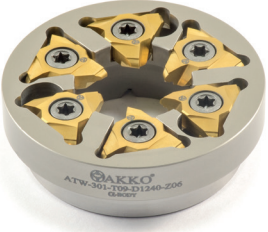

FİYATI

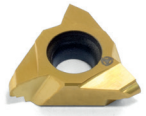



	B11015	-
	B11023	-
	B11024	-
	B11025	-
	B11026	-
	B11027	-
	B11028	-

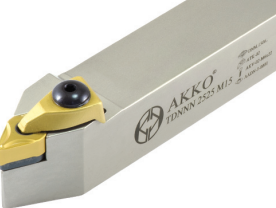

WHIRLING UÇLARI ve TAKIMLARI

	MAKİNE	TAHRİKLİ WHİRLİNG ÜNİTESİ	WHİRLİNG RİNG KODU	KESİCİ UÇ	FİYATI
	STAR	5914 72 00/68172	ATW-301-T09-D1240-Z06	T09....	150,00 €
		BTW1000	ATW-302-T09-D1233-Z06	T09....	150,00 €
		GSW101	ATW-303-T09-D0620-Z06	T09....	150,00 €
	CITIZEN	MWS101/KSW101			
		LSW101/BSW215/ LSW215315	ATW-304-T09-D1240-Z06	T09....	150,00 €
		LSW424	ATW-305-T09-D1245-Z06	T09....	150,00 €
	TORNOS	306101/307087 417617	ATW-306-T09-D1240-Z06 ATW-307-T09-D1250-Z06	T09.... T09....	156,00 € 161,00 €
	WTO	TN762004 TN762006	ATW-308-T09-D1142-Z06 ATW-309-T09-D2054-Z08	T09.... T09....	150,00 € 172,00 €
		3234 Y342	ATW-310-T09-D1252-Z06	T09....	161,00 €
		3268 Y452	ATW-311-T09-D1252-Z06	T09....	156,00 €
	TSUGAMI	3268 Y271	ATW-312-T09-D1252-Z06	T09....	156,00 €
		3214 Y342	ATW-313-T09-D1650-Z06	T09....	161,00 €
		3234 Y342	ATW-314-T09-D2052-Z06	T09....	161,00 €
		3281-Y451	ATW-316-T09-D1252-Z06	T09....	156,00 €
	HANWHA	MADAULA	ATW-315-T09-D1245-Z06	T09....	156,00 €

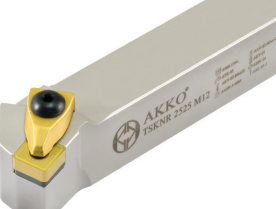
	T09.HC290.D12	30,00 €
	T09.HC350.D12	30,00 €
	T09.HC390.D12	30,00 €
	T09.HC420.D12	30,00 €
	T09.HD400.D12	30,00 €
	T09.HD450.D12	30,00 €
	T09.M200.D12	30,00 €
	T09.M250.D12	30,00 €
	T09.M300.D12	30,00 €
	T09.M350.D12	30,00 €
	T09.M400.D12	30,00 €
	T09.M500.D12	30,00 €
	T09.M600.D12	30,00 €
	T09.M700.D12	30,00 €
	T09.M800.D12	30,00 €

T - TİP SAĞ-SOL-NÖTR DIŞ ÇAP TORNA KATERLERİ			FİYATI
 <p>75°</p>	TCBNR / L CNM. 1606..	2525 M16	28,70 €
 <p>75°</p>	TCKNR / L CNM. 1204.. CNM. 1606..	2020 K12	24,80 €
		2525 M12	25,00 €
		2525 M16	28,70 €
		3232 P12	29,30 €
		3232 P16	30,80 €
 <p>95°</p>	TCLNR / L CNM. 1204.. CNM. 1606..	2020 K12	24,80 €
		2525 M12	25,00 €
		3232 P12	29,30 €
		4040 S12	43,80 €
		5050 S12	61,90 €
		2525 M16	28,70 €
		3232 P16	30,80 €
 <p>50°</p>	TCMNN CNM. 1204.. CNM. 1606..	1616 H12	24,40 €
		2020 K12	24,80 €
		2525 M12	25,00 €
		3232 P12	29,30 €
		2525 M16	28,70 €
		3232 P16	30,80 €
VENI 4040 S16	45,70 €		
 <p>40°</p>	TCZNN CNM. 1204.. CNM. 1606..	2020 K12	24,80 €
		2525 M12	25,00 €
		3232 P12	29,30 €
		2525 M16	28,70 €
		3232 P16	30,80 €
 <p>107.5°</p>	TDHNR / L DNM. 1104.. DNM. 1506..	2525 M11	25,00 €
		2020 K15	24,80 €
		2525 M15	25,00 €
		3232 P15	29,30 €

T - TİP SAĞ-SOL-NÖTR DIŞ ÇAP TORNA KATERLERİ		FİYATI	
 <p>93°</p>	TDJNR / L DNM. 1104.. DNM. 1504.. DNM. 1506..	1616 H11	24,40 €
		2020 K11	24,80 €
		2525 M11	25,00 €
		2020 K15	24,80 €
		2525 M15	25,00 €
		3232 P15	29,30 €
		4040 S15	43,80 €
		YENİ 5050 S15	61,90 €
		2020 K1504	24,80 €
		2525 M1504	25,00 €
		3232 P1504	29,30 €
		4040 S1504	43,80 €
		 <p>62.5°</p>	TDNNN DNM. 1104.. DNM. 1506..
2020 K11	24,80 €		
2525 M11	25,00 €		
2020 K15	24,80 €		
2525 M15	25,00 €		
3232 P15	29,30 €		
YENİ 4040 S15	43,80 €		
YENİ 5050 S15	61,90 €		
 <p>45°</p>	TSDNN SNM. 1204.. SNM. 1506..	1616 H12	24,40 €
		2020 K12	24,80 €
		2525 M12	25,00 €
		3232 P12	29,30 €
		YENİ 2525 M15	28,70 €
		3232 P15	30,80 €
		YENİ 4040 S15	45,70 €
 <p>75°</p>	TSKNR / L SNM. 1204.. SNM. 1506..	2020 K12	24,80 €
		2525 M12	25,00 €
		3232 P12	29,30 €
		3232 P15	30,80 €
 <p>45°</p>	TSSNR / L SNM. 1204.. SNM. 1506..	2020 K12	24,80 €
		2525 M12	25,00 €
		3232 P12	29,30 €
		2525 M15	28,70 €
		3232 P15	30,80 €

T - TİP SAĞ-SOL-NÖTR DIŞ ÇAP TORNA KATERLERİ			FİYATI
 <p>60°</p>	TTENN TNM. 1604.. TNM. 2204..	2020 K16	24,80 €
		2525 M16	25,00 €
		3232 P16	29,30 €
		2525 M22	25,00 €
		3232 P22	29,30 €
		YENİ 4040 S22	43,80 €
 <p>90°</p>	TTGNR / L TNM. 1604.. TNM. 2204..	2020 K16	24,80 €
		2525 M16	25,00 €
		3232 P16	29,30 €
		2525 M22	25,00 €
		3232 P22	29,30 €
		YENİ 4040 S22	43,80 €
 <p>93°</p>	TTJNR / L TNM. 1604.. TNM. 2204..	2020 K16	24,80 €
		2525 M16	25,00 €
		3232 P16	29,30 €
		2525 M22	25,00 €
		3232 P22	29,30 €
		YENİ 4040 S22	43,80 €
 <p>107.5°</p>	TVHNR / L VNM. 1604..	2020 K16	24,80 €
		2525 M16	25,00 €
		3232 P16	29,30 €
 <p>93°</p>	TVJNR / L VNM. 1604..	2020 K16	24,80 €
		2525 M16	25,00 €
		3232 P16	29,30 €
 <p>72.5°</p>	TVVNN VNM. 1604..	2020 K16	24,80 €
		2525 M16	25,00 €
		3232 P16	29,30 €

T - TİP SAĞ-SOL-NÖTR DIŞ ÇAP TORNA KATERLERİ			FİYATI
 <p>95°</p>	TWLNR / L WNM. 0604.. WNM. 0804..	1616 H06	24,40 €
		2020 K06	24,80 €
		2525 M06	25,00 €
		2020 K08	24,80 €
		2525 M08	25,00 €
		3232 P08	29,30 €
		4040 S08	43,80 €
		YENİ 5050 S08	61,90 €





T-SİSTEM İÇTEN SOĞUTMA KANALLI DIŞ TORNA KATERLERİ			FİYATI
 <p>95°</p>	TCLNR / L CNM. 1204..	2020 K12-H	49,60 €
		2525 M12-H	50,00 €
		3232 P12-H	58,60 €

 <p>93°</p>	TDJNR / L DNM. 1506..	2020 K15-H	49,60 €
		2525 M15-H	50,00 €
		3232 P15-H	58,60 €





 <p>62.5°</p>	TDNNN DNM. 1506..	2525 M15-H	50,00 €

 <p>95°</p>	TWLNR / L WNM. 0804..	2020 K08-H	49,60 €
		2525 M08-H	50,00 €
		3232 P08-H	58,60 €





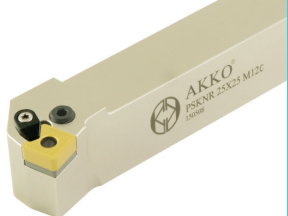

M - TİP SAĞ-SOL-NÖTR DIŞ ÇAP TORNA KATERLERİ			FİYATI
 <p>60°</p>	MTENN TNM. 1604.. TNM. 2204..	2020 K16	24,80 €
		2525 M16	25,00 €
		3232 P16	29,30 €
		2525 M22	25,00 €
		3232 P22	29,30 €
		4040 S22	43,80 €
 <p>93°</p>	MTJNR / L TNM. 1604.. TNM. 2204..	2020 K16	24,80 €
		2525 M16	25,00 €
		3232 P16	29,30 €
		2525 M22	25,00 €
		3232 P22	29,30 €
		4040 S22	43,80 €
 <p>95°</p>	MWLNR / L WNM. 0604.. WNM. 0804..	1616 H06	24,40 €
		2020 K06	24,80 €
		2525 M06	25,00 €
		2020 K08	24,80 €
		2525 M08	25,00 €
		3232 P08	29,30 €
 <p>50°</p>	MWMNN WNM. 0604.. WNM. 0804..	1616 H06	24,40 €
		2020 K06	24,80 €
		2525 M06	25,00 €
		2020 K08	24,80 €
		2525 M08	25,00 €
		3232 P08	29,30 €

P - TİP SAĞ-SOL-NÖTR DIŞ ÇAP TORNA KATERLERİ			FİYATI
 <p>75°</p>	PCBNR / L CNM. 1204.. CNM. 1606.. CNM. 1906.. CNM. 2509..	2020 K12C	24,80 €
		2525 M12C	25,00 €
		3232 P12C	29,30 €
		2525 M16C	28,70 €
		3232 P16C	30,80 €
		3232 P19C	34,70 €
		4040 S19C	47,60 €
		4040 S25C	53,00 €
		YENİ 5050 S25C	68,30 €
 <p>95°</p>	PCLNR / L CNM. 0903.. CNM. 1204.. CNM. 1606.. CNM. 1906.. CNM. 2509..	1616 H09	24,40 €
		2020 K09	24,80 €
		2525 M09	25,00 €
		1616 H12	24,40 €
		2020 K12C	24,80 €
		2525 M12C	25,00 €
		3232 P12C	29,30 €
		2525 M16C	28,70 €
		3232 P16C	30,80 €
		2525 M19C	30,80 €
		3232 P19C	34,70 €
		4040 S19C	47,60 €
		4040 S25C	53,00 €
		5050 S25C	68,30 €
 <p>50°</p>	PCMNN CNM. 1204.. CNM. 1606.. CNM. 1906.. CNM. 2509..	2020 K12C	24,80 €
		2525 M12C	25,00 €
		YENİ 3232 P12C	29,30 €
		YENİ 2525 M16C	28,70 €
		YENİ 3232 P16C	30,80 €
		3232 P19C	34,70 €
		4040 S19C	47,60 €
		YENİ 5050 S19C	61,50 €
4040 S25C	53,00 €		
 <p>93°</p>	PDJNR / L DNM. 1104.. DNM. 1506..	1616 H11	24,40 €
		2020 K11	24,80 €
		2525 M11	25,00 €
		2020 K15C	24,80 €
		2525 M15C	25,00 €
		3232 P15C	29,30 €
		4040 S15C	43,80 €
 <p>62.5°</p>	PDNNN DNM. 1104.. DNM. 1506..	1616 H11	24,40 €
		2020 K11	24,80 €
		2525 M11	25,00 €
		2020 K15C	24,80 €
		2525 M15C	25,00 €
		3232 P15C	29,30 €

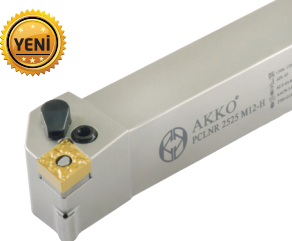
P - TİP SAĞ-SOL-NÖTR DIŞ ÇAP TORNA KATERLERİ			FİYATI
 <p>75°</p>	PSBNR / L SNM. 0903.. SNM. 1204.. SNM. 1506.. SNM. 1906.. SNM. 2509..	1616 H09	24,40 €
		YENİ 2020 K09	24,80 €
		2020 K12	24,80 €
		2525 M12C	25,00 €
		3232 P12C	29,30 €
		2525 M15	28,70 €
		3232 P15C	30,80 €
		3232 P19C	34,70 €
		4040 S19C	47,60 €
		4040 S25C	53,00 €
		5050 S25C	68,30 €
 <p>45°</p>	PSDNN SNM. 0903.. SNM. 1204.. SNM. 1506.. SNM. 1906.. SNM. 2509..	1616 H09	24,40 €
		2020 K12C	24,80 €
		2525 M12C	25,00 €
		3232 P12C	29,30 €
		YENİ 2020 K15C	28,80 €
		2525 M15C	28,70 €
		3232 P19C	34,70 €
		YENİ 4040 S19C	47,60 €
		YENİ 5050 S19C	61,50 €
		4040 S25C	53,00 €
		YENİ 5050 S25C	68,30 €
 <p>75°</p>	PSKNR / L SNM. 0903.. SNM. 1204.. SNM. 1506.. SNM. 1906.. SNM. 2509..	2020 K09	24,80 €
		2020 K12C	24,80 €
		2525 M12C	25,00 €
		3232 P12C	29,30 €
		2525 M15C	28,70 €
		3232 P15C	30,80 €
		3232 P19C	34,70 €
		4040 S19C	47,60 €
		4040 S25C	53,00 €
		5050 S25C	68,30 €
 <p>45°</p>	PSSNR / L SNM. 0903.. SNM. 1204.. SNM. 1506.. SNM. 1906.. SNM. 2509..	1616 H09	24,40 €
		2020 K09	24,80 €
		2020 K12C	24,80 €
		2525 M12C	25,00 €
		3232 P12C	29,30 €
		YENİ 3232 P15C	30,80 €
		3232 P19C	34,70 €
		4040 S19C	47,60 €
4040 S25C	53,00 €		
 <p>90°</p>	PTFNR / L TNM. 1604.. TNM. 2204.. TNM. 2706..	1616 H16	24,40 €
		2020 K16	24,80 €
		2525 M16	25,00 €
		3232 P16	29,30 €
		2525 M22C	25,00 €
		3232 P22C	29,30 €
		YENİ 4040 S27	53,00 €





P - TİP SAĞ-SOL-NÖTR DIŞ ÇAP TORNA KATERLERİ			FİYATI
 <p>90°</p>	PTGNR / L TNM. 1103.. TNM. 1604.. TNM. 2204.. TNM. 2706..	YENİ 1010 E11	20,00 €
		YENİ 1212 F11	20,00 €
		YENİ 1616 H11	22,60 €
		1616 H16	24,40 €
		2020 K16	24,80 €
		2525 M16	25,00 €
		YENİ 3232 P16	29,30 €
		2525 M22C	25,00 €
		3232 P22C	29,30 €
		YENİ 4040 S27	53,00 €
 <p>93°</p>	PTJNR / L TNM. 1103.. TNM. 1604.. TNM. 2204.. TNM. 2706..	YENİ 1010 E11	20,00 €
		YENİ 1212 F11	20,00 €
		YENİ 1616 H11	22,60 €
		1616 H16	24,40 €
		2020 K16	24,80 €
		2525 M16	25,00 €
		3232 P16	29,30 €
		2525 M22C	25,00 €
		3232 P22C	29,30 €
		YENİ 4040 S27	53,00 €
 <p>60°</p>	PTTNR / L TNM. 1604.. TNM. 2204..	1616 H16	24,40 €
		2020 K16	24,80 €
		2525 M16	25,00 €
		3232 P16	29,30 €
		2525 M22C	25,00 €
		3232 P22C	29,30 €
 <p>95°</p>	PWLNR / L WNM. 0604.. WNM. 0804..	1616 H06	24,40 €
		2020 K06	24,80 €
		2525 M06	25,00 €
		YENİ 3232 P06	29,30 €
		1616 H08	24,40 €
		2020 K08C	24,80 €
		2525 M08C	25,00 €
		3232 P08C	29,30 €

P-SİSTEM İÇTEN SOĞUTMA KANALLI DIŞ TORNA KATERLERİ			FİYATI
 <p>95°</p>	PCLNR / L CNM. 1204..	2020 K12-H	39,70 €
		2525 M12-H	40,00 €
		3232 P12-H	47,00 €

P-SİSTEM İÇTEN SOĞUTMA KANALI DIŞ TORNA KATERLERİ			FİYATI
 <p>YENİ</p> <p>AKKO® PDJNR 2525 M15-H</p> <p>93°</p>	PDJNR / L DNM. 1506..	2020 K15-H	39,70 €
		2525 M15-H	40,00 €
		3232 P15-H	47,00 €
 <p>YENİ</p> <p>AKKO® PDNNN 2525 M15-H</p> <p>62.5°</p>	PDNNN DNM. 1506..	2525 M15-H	40,00 €
 <p>YENİ</p> <p>AKKO® PWLNR 2525 M08-H</p> <p>95°</p>	PWLNR / L WNM. 0804..	2020 K08-H	39,70 €
		2525 M08-H	40,00 €
			

C - TİP SAĞ-SOL DIŞ ÇAP TORNA KATERLERİ			FİYATI
 <p>AKKO® CKJNR 2525 M16</p> <p>93°</p>	CKJNR / L KNUX 1604..	2020 K16	24,80 €
		2525 M16	25,00 €
		3232 P16	29,30 €
		4040 S16	43,80 €

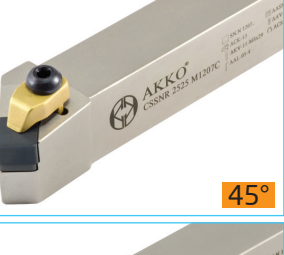
C - TİP SAĞ-SOL NÖTR SERAMİK UÇLAR İÇİN DIŞ TORNA KATERLERİ			FİYATI
 <p>95°</p>	CCLNR / L	2525 M1207C	30,80 €
	CN.N 1207.. CN.N 1607..	3232 P1207C	34,70 €
		2525 M1607C	34,50 €
 <p>93°</p>	CDJNR / L	2525 M1107C	30,80 €
	DN.N 1107.. DN.N 1507..	2525 M1507C	30,80 €
		3232 P1507C	34,70 €
 <p>62.5°</p>	CDNNN	2525 M1107C	30,80 €
	DN.N 1107..		
 <p>R</p>	CRDCN	2525 M06CV	39,90 €
	RCGX 060600 RCGX 090700 RCGX 120700	3225 P06CV	44,20 €
		4040 S06CV	56,90 €
		2525 M09CV	39,90 €
		3225 P09CV	44,20 €
		4040 S09CV	56,90 €
		2525 M12CV	39,90 €
		3225 P12CV	44,20 €
		4040 S12CV	56,90 €
	CRDCR / L	3225 P06CV	44,20 €
	RCGX 060600 RCGX 090700 RCGX 120700	3225 P09CV	44,20 €
		3225 P12CV	44,20 €
 <p>45°</p>	CSDNN	2525 M1207C	30,80 €
	SN.N 1207..	3232 P1207C	34,70 €

C - TİP SAĞ-SOL NÖTR SERAMİK UÇLAR İÇİN DIŞ TORNA KATERLERİ			FİYATI
 <p>75°</p>	CSKNR / L SN.N 1207..	2525 M1207C	30,80 €
		3232 P1207C	34,70 €
 <p>45°</p>	CSRNR / L SN.N 1207..	2525 M1207C	30,80 €
		3232 P1207C	34,70 €
 <p>45°</p>	CSSNR / L SN.N 1207..	2525 M1207C	30,80 €
		3232 P1207C	34,70 €
 <p>93°</p>	CTJNR / L TN.N 1607..	2525 M1607C	30,80 €
		3232 P1607C	34,70 €
S - TİP SAĞ-SOL NÖTR DIŞ ÇAP TORNA KATERLERİ			FİYATI
 <p>90°</p>	SCACR / L CC.T 0602.. CC.T 09T3.. CC.T 1204..	0808 E06	15,70 €
		1010 E06	15,70 €
		1212 F09	15,70 €
		1616 H09	17,70 €
		2020 K09	18,10 €
		2020 K12	18,10 €
		2525 M12-Z	17,70 €
		2525 M12	19,20 €

S - TİP SAĞ-SOL NÖTR DIŞ ÇAP TORNA KATERLERİ			FİYATI
 <p>95°</p>	SCLCR / L CC.T 0602.. CC.T 09T3.. CC.T 1204..	0808 E06	15,70 €
		1010 E06	15,70 €
		1212 F06	15,70 €
		1010 E09	15,70 €
		1212 F09	15,70 €
		1616 H09	17,70 €
		2020 K09	18,10 €
		2525 M09	19,20 €
		1616 H12	17,70 €
		2020 K12-Z	16,60 €
		2020 K12	18,10 €
		2525 M12-Z	17,70 €
		2525 M12	19,20 €
		 <p>50°</p>	SCMCN CC.T 0602.. CC.T 09T3.. CC.T 1204..
1010 E06	15,70 €		
1212 F06	15,70 €		
1212 F09	15,70 €		
1616 H09	17,70 €		
2020 K12	18,10 €		
2525 M12	19,20 €		
 <p>107.5°</p>	SDHCR / L DC.T 0702.. DC.T 11T3..	0808 E07	15,70 €
		1010 E07	15,70 €
		1212 F07	15,70 €
		1616 H07	17,70 €
		1616 H11	17,70 €
		2020 K11	18,10 €
		2525 M11	19,20 €
		3232 P11	22,40 €
 <p>93°</p>	SDJCR / L DC.T 0702.. DC.T 11T3..	0808 E07	15,70 €
		1010 E07	15,70 €
		1212 F07	15,70 €
		1616 H07	17,70 €
		1616 H11	17,70 €
		2020 K11	18,10 €
		2525 M11	19,20 €
		3232 P11	22,40 €
 <p>62.5°</p>	SDNCN DC.T 0702.. DC.T 11T3..	0808 E07	15,70 €
		1010 E07	15,70 €
		1212 F07	15,70 €
		1616 H07	17,70 €
		1616 H11	17,70 €
		2020 K11	18,10 €
		2525 M11	19,20 €
		3232 P11	22,40 €

S - TİP SAĞ-SOL NÖTR DIŞ ÇAP TORNA KATERLERİ
FİYATI

 <p style="text-align: right;">R</p>	SRDCN	1616 H06	17,70 €	
	RC.T 0602..	2020 K06	18,10 €	
	RC.T 0803..	2525 M06	19,20 €	
	RC.T 10T3..	1616 H08C	17,70 €	
	RC.T 1204..	2020 K08C	18,10 €	
	RC.T 1605..	2525 M08C	19,20 €	
	RC.T 2006..	1616 H10C	17,70 €	
	RC.T 2507..	2020 K10C	18,10 €	
	RC.T 3209..	2525 M10C	19,20 €	
		3232 P10C	22,40 €	
		2020 K12C	18,10 €	
		2525 M12C	19,20 €	
		3232 P12C	22,40 €	
		2525 M16C	20,90 €	
		3232 P16C	22,40 €	
		2525 M20C	39,90 €	
	3232 P20C	46,60 €		
	3232 P25C	46,60 €		
	3232 P32C	46,60 €		
 <p style="text-align: right;">R</p>	SRDCR / L	3232 T06	39,60 €	
	RC.T 0602.. RC.T 1204..	3232 P12C	22,40 €	
 <p style="text-align: right;">R</p>	SRGCR / L	1616 H06	17,70 €	
	RC.T 0602..	2020 K06	18,10 €	
	RC.T 0803..	1616 H08C	17,70 €	
	RC.T 10T3..	2020 K08C	18,10 €	
	RC.T 1204..	2525 M08C	19,20 €	
		1616 H10C	17,70 €	
		2020 K10C	18,10 €	
		2525 M10C	19,20 €	
		3232 P10C	22,40 €	
		2020 K12C	18,10 €	
		2525 M12C	19,20 €	
		3232 P12C	22,40 €	
	 <p style="text-align: right;">R</p>	SRHCR / L	2525 K06	41,60 €
		RC.T 0602..	2525 K08	41,60 €
		RC.T 0803..	2525 K10	41,60 €
		RC.T 10T3..	2525 K12	41,60 €
RC.T 1204..		2525 K16	41,60 €	
RC.T 1606..				

S - TİP SAĞ-SOL NÖTR DIŞ ÇAP TORNA KATERLERİ			FİYATI
 <p>SRXCR / L RC.T 0803.. RC.T 10T3.. RC.T 1204..</p> <p>R</p>	3232 X08C	42,70 €	
	3232 X10C	42,70 €	
	3232 X12C	42,70 €	
 <p>SSDCN SC.T 09T3.. SC.T 1204.. SC.T 1605..</p> <p>45°</p>	1212 F09	15,70 €	
	1616 H09-Z	15,90 €	
	1616 H09	17,70 €	
	2020 K09-Z	16,60 €	
	2020 K09	18,10 €	
	1616 H12-Z	15,90 €	
	1616 H12	17,70 €	
	2020 K12	18,10 €	
	2525 M12	19,20 €	
	2020 K16-Z	18,10 €	
 <p>SSSCR / L SC.T 09T3.. SC.T 1204..</p> <p>45°</p>	1212 F09	15,70 €	
	1616 H09-Z	15,90 €	
	1616 H09	17,70 €	
	2020 K09-Z	16,60 €	
	2020 K09	18,10 €	
	1616 H12	17,70 €	
	2020 K12-Z	16,60 €	
	2020 K12	18,10 €	
	2525 M12-Z	17,70 €	
	2525 M12	19,20 €	
 <p>STFRCR / L TC.T 0902.. TC.T 1102.. TC.T 16T3..</p> <p>90°</p>	0808 E09	15,70 €	
	1010 E09	15,70 €	
	1212 F11	15,70 €	
	1616 H11	17,70 €	
	1616 H16	17,70 €	
	2020 K16	18,10 €	
	2525 M16	19,20 €	
	3232 P16	22,40 €	
 <p>STGCR / L TC.T 0902.. TC.T 1102.. TC.T 16T3..</p> <p>90°</p>	0808 E09	15,70 €	
	1010 E09	15,70 €	
	1212 F11	15,70 €	
	1616 H11	17,70 €	
	1616 H16	17,70 €	
	2020 K16	18,10 €	
	2525 M16	19,20 €	
	3232 P16	22,40 €	

S - TİP SAĞ-SOL NÖTR DIŞ ÇAP TORNA KATERLERİ			FİYATI
 <p>93°</p>	STJCR / L TC.T 0902.. TC.T 1102.. TC.T 16T3..	0808 E09	15,70 €
		1010 E09	15,70 €
		1212 F11	15,70 €
		1616 H11	17,70 €
		1616 H16	17,70 €
		2020 K16	18,10 €
		2525 M16	19,20 €
		3232 P16	22,40 €
 <p>90°</p>	STCCN TC.T 1102.. TC.T 16T3.. TC.T 2204..	2020 L11	25,90 €
		1616 K16	24,40 €
		2020 M16	25,90 €
		2525 P16	27,60 €
		3232 R16	31,00 €
		2525 P22	27,60 €
 <p>93°</p>	STUCR / L TC.T 0902.. TC.T 1102.. TC.T 16T3..	0808 E09	15,70 €
		1010 E09	15,70 €
		1212 F11	15,70 €
		1616 H11	17,70 €
		1616 H16	17,70 €
		2020 K16	18,10 €
		2525 M16	19,20 €
		3232 P16	22,40 €
 <p>107.5°</p>	SVHBR / L VBM. 1103.. VBM. 1604..	1212 F11	15,70 €
		1616 H11	17,70 €
		2020 K11	18,10 €
		2020 K16	18,10 €
		2525 M16	19,20 €
		3232 P16	22,40 €
 <p>107.5°</p>	SVHCR / L VC.T 1103.. VC.T 1604..	1212 F11	15,70 €
		1616 H11	17,70 €
		2020 K11	18,10 €
		2020 K16	18,10 €
		2525 M16	19,20 €
		3232 P16	22,40 €
 <p>93°</p>	SVJBR / L VBM. 1103.. VBM. 1604..	1212 F11	15,70 €
		1616 H11	17,70 €
		2020 K11	18,10 €
		1616 H16	17,70 €
		2020 K16	18,10 €
		2525 M16	19,20 €
		3232 P16	22,40 €



S - TİP SAĞ-SOL NÖTR DIŞ ÇAP TORNA KATERLERİ			FİYATI		
 <p>93°</p>	SVJCR / L VC.T 1103.. VC.T 1604..	1212 F11	15,70 €		
		1616 H11	17,70 €		
		2020 K11	18,10 €		
		YENİ 2525 M11	17,70 €		
		1212 F16	15,70 €		
		2020 K16	18,10 €		
		2525 M16	19,20 €		
		3232 P16	22,40 €		
 <p>72.5°</p>	SVVBN VBM. 1103.. VBM. 1604..	1212 F11	15,70 €		
		1616 H11	17,70 €		
		2020 K11	18,10 €		
		2020 K16	18,10 €		
		2525 M16	19,20 €		
		3232 P16	22,40 €		
		 <p>72.5°</p>	SVVCN VC.T 1103.. VC.T 1604..	1212 F11	15,70 €
				1616 H11	17,70 €
2020 K11	18,10 €				
2020 K16	18,10 €				
2525 M16	19,20 €				
3232 P16	22,40 €				
S - TİP SAĞ-SOL İSVİÇRE TİPİ KAYAR OTOMAT MAKİNA TAKIMLARI				FİYATI	
 <p>90°</p>	SCACR / L CC.T 0602.. CC.T 09T3..			0808 X06-S	16,60 €
		1010 K06-S	17,70 €		
		1212 G06-S	17,70 €		
		1212 K06-S	18,10 €		
		YENİ 1616 F06-S	18,10 €		
		YENİ 1616 K06-S	19,20 €		
		YENİ 1212 G09-S	17,70 €		
		1212 K09-S	18,10 €		
		YENİ 1616 F09-S	18,10 €		
		1616 K09-S	19,20 €		
		2020 K09-S	19,80 €		
		 <p>95°</p>	SCLCR / L CC.T 0602.. CC.T 09T3..	0808 X06-S	16,60 €
1010 X06-S	16,60 €				
1212 G06-S	17,70 €				
1212 X06-S	17,70 €				
1212 K06-S	18,10 €				
1616 F06-S	18,10 €				
1616 X06-S	18,10 €				
1212 G09-S	17,70 €				
1212 X09-S	17,70 €				
1616 F09-S	18,10 €				
1616 G09-S	18,10 €				
1616 X09-S	18,10 €				
2020 X09-S	19,20 €				

S - TİP SAĞ-SOL İSVİÇRE TİPİ KAYAR OTOMAT MAKİNA TAKIMLARI			FİYATI
 <p>SDACR / L DC.T 0702.. DC.T 11T3..</p> <p>90°</p>	0808 X07-S	16,60 €	
	1010 K07-S	17,70 €	
	YENİ 1212 G07-S	17,70 €	
	1212 K07-S	18,10 €	
	1616 F07-S	18,10 €	
	1616 K07-S	19,20 €	
	YENİ 1212 G11-S	17,70 €	
	1212 K11-S	18,10 €	
	1616 F11-S	18,10 €	
	1616 K11-S	19,20 €	
	2020 K11-S	19,80 €	
 <p>SDJCR / L DC.T 0702.. DC.T 11T3..</p> <p>93°</p>	0808 X07-S	16,60 €	
	1010 X07-S	16,60 €	
	1212 G07-S	17,70 €	
	1212 X07-S	17,70 €	
	1616 F07-S	18,10 €	
	1616 X07-S	18,10 €	
	2020 X07-S	19,20 €	
	1212 G11-S	17,70 €	
	1212 X11-S	17,70 €	
	1212 K11-S	18,10 €	
	1616 F11-S	18,10 €	
1616 X11-S	18,10 €		
1616 K11-S	19,20 €		
2020 X11-S	19,20 €		
 <p>STGCR / L TC.T 1102.. TC.T 16T3..</p> <p>91°</p>	1216 K11-S	19,20 €	
	1616 K11-S	19,20 €	
	1216 K16-S	19,20 €	
	1616 K16-S	19,20 €	
 <p>SVJBR / L VBM. 1103..</p> <p>93°</p>	1616 K11-S	19,20 €	
 <p>SVACR / L VC.T 1103.. VC.T 1604..</p> <p>90°</p>	YENİ 0808 X11-S	16,60 €	
	1010 K11-S	17,70 €	
	YENİ 1212 G11-S	17,70 €	
	1212 K11-S	18,10 €	
	YENİ 1616 F11-S	18,10 €	
	1616 K11-S	19,20 €	
	2020 K11-S	19,80 €	
	1212 K16-S	18,10 €	
	1616 K16-S	19,20 €	

S - TİP SAĞ-SOL İSVİÇRE TİPİ KAYAR OTOMAT MAKİNA TAKIMLARI			FİYATI
 <p>93°</p>	SVJCR / L VC.T 1103..	0808 X11-S	16.60 €
		YENİ 1010 K11-S	17.70 €
		YENİ 1212 G11-S	17.70 €
		1212 K11-S	18.10 €
		YENİ 1616 F11-S	18.10 €
		YENİ 1616 K11-S	19.20 €
		YENİ 2020 K11-S	19.80 €

SEC TOOLS			FİYATI
 <p>YENİ</p>	ASTB-1212-L84-H	50,00 €	
	ASTB-1616-L90-H	59,00 €	
 <p>93°</p>	SDJCR / L	12X43.3-07	53,00 €
	DC.T 070202 DC.T 11T302	12X43.3-07-H	63,00 €
		16X43.3-07	53,00 €
		16X43.3-07-H	63,00 €
		12X43.3-11	53,00 €
		12X43.3-11-H	63,00 €
		16X43.3-11	53,00 €
16X43.3-11-H		63,00 €	
 <p>93°</p>	SVJCR / L	12X43.3-11	53,00 €
	VC.T 110302	12X43.3-11-H	63,00 €
		16X43.3-11	53,00 €
		16X43.3-11-H	63,00 €
 <p>93°</p>	SER / L	SER/L-16x43.3-11	53,00 €
	TER / L	SER/L-12x43.3-11	53,00 €
	11 ER/EL 16 ER/EL	TER/L-16x43.3-16	63,00 €





T - TİP SAĞ-SOL DELİK İÇİ TORNA KATERLERİ			FİYATI
 <p>95°</p>	TCLNR / L CNM. 0903.. CNM. 1204.. CNM. 1606..	S25S TCLNR / L 09-Z	26,70 €
		S25S TCLNR / L 09	30,60 €
		S25S TCLNR / L 12-Z	26,70 €
		S25S TCLNR / L 12	30,60 €
		S32T TCLNR / L 12	37,10 €
		S40U TCLNR / L 12	51,30 €
		S50V TCLNR / L 12	60,60 €
		S32T TCLNR / L 16	40,10 €
		S40U TCLNR / L 16	56,90 €
		S50V TCLNR / L 16	65,50 €
 <p>62.5°</p>	TD-NR / L DNM. 1506..	S32T TD-NR / L 15	37,10 €
		S40U TD-NR / L 15	51,30 €
		S50V TD-NR / L 15	60,60 €
 <p>107.5°</p>	TDQNR / L DNM. 1104.. DNM. 1506..	S25S TDQNR / L 11-Z	26,70 €
		S25S TDQNR / L 11	30,60 €
		S32T TDQNR / L 11	37,10 €
		S25S TDQNR / L 15	30,60 €
		S32T TDQNR / L 15	37,10 €
		S40U TDQNR / L 15	51,30 €
		S50V TDQNR / L 15	60,60 €
 <p>93°</p>	TDUNR / L DNM. 1104.. DNM. 1506..	S25S TDUNR / L 11-Z	26,70 €
		S25S TDUNR / L 11	30,60 €
		S32T TDUNR / L 11	37,10 €
		S25S TDUNR / L 15	30,60 €
		S32T TDUNR / L 15	37,10 €
		S40U TDUNR / L 15	51,30 €
		S50V TDUNR / L 15	60,60 €
 <p>75°</p>	TSKNR / L SNM. 1204..	S25S TSKNR / L 12-Z	26,70 €
		S25S TSKNR / L 12	30,60 €
		S32T TSKNR / L 12	37,10 €
		S40U TSKNR / L 12	51,30 €

T - TİP SAĞ-SOL DELİK İÇİ TORNA KATERLERİ		FİYATI		
 <p>60°</p>	TT-NR / L TNM. 1604..	S25S TT-NR / L 16-Z 26,70 € S25S TT-NR / L 16 30,60 € S32T TT-NR / L 16 37,10 €		
	 <p>93°</p>	TTUNR / L TNM. 1604.. TNM. 2204..	S25S TTUNR / L 16-Z 26,70 € S25S TTUNR / L 16 30,60 € S32T TTUNR / L 16 37,10 € S25S TTUNR / L 22 30,60 € S32T TTUNR / L 22 37,10 € S40U TTUNR / L 22 51,30 € S50V TTUNR / L 22 60,60 €	
		 <p>93°</p>	TVUNR / L VNM. 1604..	S25S TVUNR / L 16 30,60 € S32T TVUNR / L 16 37,10 € S40U TVUNR / L 16 51,30 €
			 <p>95°</p>	TWLNR / L WNM. 0604.. WNM. 0804..

C - TİP SAĞ-SOL DELİK İÇİ TORNA KATERLERİ		FİYATI
 <p>93°</p>	CKUNR / L KNUX 1604..	S25S CKUNR / L 16 30,60 € S32T CKUNR / L 16 37,10 € S40U CKUNR / L 16 51,30 € S50V CKUNR / L 16 60,60 €



M - TİP SAĞ-SOL DELİK İÇİ TORNA KATERLERİ			FİYATI
 <p>95°</p>	MCLNR / L CNM. 1204..	S20R MCLNR / L 12	25,40 €
		S25S MCLNR / L 12-Z	26,70 €
		S25S MCLNR / L 12	30,60 €
		S32T MCLNR / L 12	37,10 €
 <p>93°</p>	MDUNR / L DNM. 1104.. DNM. 1506..	S20R MDUNR / L 11	25,40 €
		S25S MDUNR / L 11	26,70 €
		YENİ S32T MDUNR / L 11	37,10 €
		S25S MDUNR / L 15-Z	26,70 €
		S25S MDUNR / L 15	30,60 €
		S32T MDUNR / L 15	37,10 €
		S40U MDUNR / L 15	51,30 €
		S50V MDUNR / L 15	60,60 €
 <p>90°</p>	MTFNR / L TNM. 1604.. TNM. 2204..	S20R MTFNR / L 16	25,40 €
		S25S MTFNR / L 16	30,60 €
		S32T MTFNR / L 16	37,10 €
		S40U MTFNR / L 16	51,30 €
		S32T MTFNR / L 22	37,10 €
		S40U MTFNR / L 22	51,30 €
		S50V MTFNR / L 22	60,60 €
 <p>60°</p>	MT-NR / L TNM. 1604.. TNM. 2204..	S20R MT-NR / L 16	25,40 €
		S25S MT-NR / L 16-Z	26,70 €
		S25S MT-NR / L 16	30,60 €
		S32T MT-NR / L 16	37,10 €
		S40U MT-NR / L 16	51,30 €
		S32T MT-NR / L 22	37,10 €
		S40U MT-NR / L 22	51,30 €
S50U MT-NR / L 22	60,60 €		
 <p>107.5°</p>	MTQNR / L TNM. 1604.. TNM. 2204..	S20R MTQNR / L 16	25,40 €
		S25S MTQNR / L 16-Z	26,70 €
		S25S MTQNR / L 16	30,60 €
		S32T MTQNR / L 16	37,10 €
		S40U MTQNR / L 16	51,30 €
		S32T MTQNR / L 22	37,10 €
		S40U MTQNR / L 22	51,30 €
		S50V MTQNR / L 22	60,60 €

M - TİP SAĞ-SOL DELİK İÇİ TORNA KATERLERİ		FİYATI
 <p>MTUNR / L TNM. 1604.. TNM. 2204..</p> <p>93°</p>	S20R MTUNR / L 16	25.40 €
	S25S MTUNR / L 16-Z	26.70 €
	S25S MTUNR / L 16	30.60 €
	S32T MTUNR / L 16	37.10 €
	S40U MTUNR / L 16	51.30 €
	S50V MTUNR / L 16	60.60 €
	S32T MTUNR / L 22	37.10 €
	S40U MTUNR / L 22	51.30 €
	S50V MTUNR / L 22	60.60 €
 <p>MWLNR / L WNM. 0604.. WNM. 0804..</p> <p>95°</p>	S16P MWLNR / L 06	24.80 €
	S20R MWLNR / L 06	25.40 €
	S25S MWLNR / L 06	26.70 €
	S25S MWLNR / L 08-Z	26.70 €
	S25S MWLNR / L 08	30.60 €
	S32T MWLNR / L 08	37.10 €
	S40U MWLNR / L 08	51.30 €



P - TİP SAĞ-SOL DELİK İÇİ TORNA KATERLERİ		FİYATI
 <p>PCLNR / L CNM. 0903.. CNM. 1204.. CNM. 1606.. CNM. 1906..</p> <p>95°</p>	S16P PCLNR / L 09	24,80 €
	S20R PCLNR / L 09	25,40 €
	S25S PCLNR / L 09	30,60 €
	S25S PCLNR / L 12C	30,60 €
	S32T PCLNR / L 12C	37,10 €
	S40U PCLNR / L 12C	51,30 €
	S50V PCLNR / L 12C	60,60 €
	S32T PCLNR / L 16C	40,10 €
	S40U PCLNR / L 16C	56,90 €
	S50V PCLNR / L 16C	65,50 €
	S40U PCLNR / L 19C	78,90 €
	S50V PCLNR / L 19C	87,50 €
	YENİ A20P PCLNR/L 09	29,30 €
	A25R PCLNR / L 12C	34,70 €
	A32S PCLNR / L 12C	41,60 €
	A40T PCLNR / L 12C	60,60 €
	A50U PCLNR / L 12C	72,20 €
	A32S PCLNR / L 16C	45,00 €
	A40T PCLNR / L 16C	65,10 €
	A50U PCLNR / L 16C	75,00 €
	A40T PCLNR / L 19C	89,70 €
	A50U PCLNR / L 19C	100,60 €



P - TİP SAĞ-SOL DELİK İÇİ TORNA KATERLERİ
FİYATI





 PDQNR / L DNM. 1104.. DNM. 1504.. DNM. 1506.. 107.5°	YENİ S20R PDQNR / L 11	25,40 €
	S25S PDQNR / L 11	30,60 €
	S32T PDQNR / L 15	37,10 €
	S40U PDQNR / L 15	51,30 €
	S50V PDQNR / L 15	60,60 €
	S32T PDQNR / L 1504	37,10 €
	S40U PDQNR / L 1504	51,30 €
	S50V PDQNR / L 1504	60,60 €
	A20P PDQNR / L 11	29,30 €
	A25R PDQNR / L 11	34,70 €
	A32S PDQNR / L 15	41,60 €
	A40T PDQNR / L 15	60,60 €
	A50U PDQNR / L 15	72,20 €
	A32S PDQNR / L 1504	41,60 €
A40T PDQNR / L 1504	60,60 €	
 PDXNR / L DNM. 1506.. 93°	S32T PDXNR / L 15	37,10 €
	S40U PDXNR / L 15	51,30 €
	S50V PDXNR / L 15	60,60 €
	YENİ A32S PDXNR/L 15	41,60 €
	YENİ A40T PDXNR/L 15	60,60 €
	YENİ A50U PDXNR/L 15	72,20 €
 PDUNR / L DNM. 1104.. DNM. 1506.. 93°	S20R PDUNR / L 11	25,40 €
	S25S PDUNR / L 11	30,60 €
	S25S PDUNR / L 15	30,60 €
	S32T PDUNR / L 15	37,10 €
	S40U PDUNR / L 15	51,30 €
	S50V PDUNR / L 15	60,60 €
	A20P PDUNR / L 11	29,30 €
	A25R PDUNR / L 11	34,70 €
	A32S PDUNR / L 11	41,60 €
	A32S PDUNR / L 15	41,60 €
	A40T PDUNR / L 15	60,60 €
A50U PDUNR / L 15	72,20 €	
 PSKNR / L SNM. 1204.. SNM. 1506.. 75°	YENİ S25S PSKNR / L 12C	30,60 €
	S32T PSKNR / L 12C	37,10 €
	S40U PSKNR / L 12C	51,30 €
	S50V PSKNR / L 12C	60,60 €
	YENİ S32T PSKNR / L 15	40,10 €
	S40U PSKNR / L 15	56,90 €
	YENİ S50V PSKNR / L 15	65,50 €
	YENİ A25R PSKNR/L 12C	34,70 €
	YENİ A32S PSKNR/L 12C	41,60 €
	YENİ A32S PSKNR/L 15C	45,00 €
	YENİ A40T PSKNR/L 12C	60,60 €
	YENİ A40T PSKNR/L 15C	65,10 €
	YENİ A50U PSKNR/L 12C	72,20 €
	YENİ A50U PSKNR/L 15C	75,00 €



P - TİP SAĞ-SOL DELİK İÇİ TORNA KATERLERİ		FİYATI
 <p>PTFNR / L TNM. 1604..</p> <p>90°</p>	A25R PTFNR/L 16C	34,70 €
	A32S PTFNR/L 16C	41,60 €
 <p>PTUNR / L TNM. 1604.. TNM. 2204..</p> <p>93°</p>	S16P PTUNR / L 16	24,80 €
	S20R PTUNR / L 16	25,40 €
	S25S PTUNR / L 16C	30,60 €
	S32T PTUNR / L 16C	37,10 €
	S40U PTUNR / L 16C	51,30 €
	S32T PTUNR / L 22C	37,10 €
	S40U PTUNR / L 22C	51,30 €
	S50V PTUNR / L 22C	60,60 €
	YENİ A16M PTUNR/L 16	17,70 €
	YENİ A20P PTUNR/L 16	29,30 €
	YENİ A25R PTUNR/L 16C	34,70 €
	YENİ A32S PTUNR/L 16C	41,60 €
	YENİ A32S PTUNR/L 22C	41,60 €
	YENİ A40T PTUNR/L 16C	60,60 €
YENİ A40T PTUNR/L 22C	60,60 €	
 <p>PWLNR / L WNM. 0604.. WNM. 0804..</p> <p>95°</p>	S20R PWLNR / L 06	25,40 €
	S25S PWLNR / L 06	30,60 €
	S32T PWLNR / L 06	37,10 €
	S25S PWLNR / L 08C	30,60 €
	S32T PWLNR / L 08C	37,10 €
	S40U PWLNR / L 08C	51,30 €
	S50V PWLNR / L 08C	60,60 €
	YENİ A16M PWLNR/L 06	17,70 €
	A20P PWLNR / L 06	29,30 €
	A25R PWLNR / L 06	34,70 €
	A32S PWLNR / L 06	41,60 €
	YENİ A40T PWLNR/L 06	60,60 €
	A25R PWLNR / L 08C	34,70 €
	A32S PWLNR / L 08C	41,60 €
	A40T PWLNR / L 08C	60,60 €
	A50U PWLNR / L 08C	72,20 €

S - TİP SAĞ-SOL DELİK İÇİ TORNA KATERLERİ
FİYATI





S - TİP SAĞ-SOL DELİK İÇİ TORNA KATERLERİ		FİYATI
 <p>SCLCR / L</p> <p>CC.T 0301.. CC.T 0602.. CC.T 09T3.. CC.T 1204..</p> <p>95°</p>	S0608H SCLCR / L 03	17,00 €
	S0608H SCLCR / L 06	11,20 €
	S08H SCLCR / L 06	11,20 €
	S10K SCLCR / L 06	11,60 €
	S12K SCLCR / L 06	12,50 €
	S1216P SCLCR / L 06	15,10 €
	S16P SCLCR / L 06	15,10 €
	S12K SCLCR / L 09	12,50 €
	S1416P SCLCR / L 09	15,10 €
	S16P SCLCR / L 09	15,10 €
	S1620R SCLCR / L 09	15,70 €
	S20R SCLCR / L 09	15,70 €
	S25S SCLCR / L 09-Z	17,20 €
	S25S SCLCR / L 09	21,80 €
	S32T SCLCR / L 09	30,60 €
	S25S SCLCR / L 12-Z	17,20 €
	S25S SCLCR / L 12	21,80 €
	S32T SCLCR / L 12	30,60 €
	S40U SCLCR / L 12	45,50 €
	A08H SCLCR / L 06	13,40 €
	A10H SCLCR / L 06	14,20 €
	A12H SCLCR / L 06	15,10 €
	A16M SCLCR / L 09	17,70 €
	A20P SCLCR / L 09	19,20 €
	A25R SCLCR / L 09	24,80 €
	A32S SCLCR / L 09	34,10 €
	A25R SCLCR / L 12	24,80 €
	 <p>SCFCR / L</p> <p>CC.T 0602.. CC.T 09T3.. CC.T 1204..</p> <p>90°</p>	S08H SCFCR / L 06
S10K SCFCR / L 06		11,60 €
S12K SCFCR / L 06		12,50 €
S12K SCFCR / L 09		12,50 €
S16P SCFCR / L 09		15,10 €
S20R SCFCR / L 09		15,70 €
S25S SCFCR / L 09-Z		17,20 €
S25S SCFCR / L 09		21,80 €
YENİ S25S SCFCR / L 12		21,80 €
YENİ S32T SCFCR / L 12		30,60 €
YENİ S40U SCFCR / L 12		45,50 €
YENİ A08H SCFCR/L 06		13,40 €
 <p>SD-CR / L</p> <p>DC.T 0702.. DC.T 11T3..</p> <p>62.5°</p>		S10K SD-CR / L 07
	S12K SD-CR / L 07	12,50 €
	S16P SD-CR / L 07	15,10 €
	S20R SD-CR / L 07	15,70 €
	S16P SD-CR / L 11	15,10 €
	S20R SD-CR / L 11	15,70 €
	S25S SD-CR / L 11-Z	17,20 €
	S25S SD-CR / L 11	21,80 €
	S32T SD-CR / L 11	30,60 €
	S40U SD-CR / L 11	45,50 €



S - TİP SAĞ-SOL DELİK İÇİ TORNA KATERLERİ			FİYATI
 <p>117.5°</p>	SDPCR / L DC.T 0702.. DC.T 11T3..	S10K SDPCR / L 07	11,60 €
		S12K SDPCR / L 07	12,50 €
		S16P SDPCR / L 11	15,10 €
		S20R SDPCR / L 11	15,70 €
		S25S SDPCR / L 11	21,80 €
 <p>107.5°</p>	SDQCR / L DC.T 0702.. DC.T 11T3..	S10K SDQCR / L 07	11,60 €
		S12K SDQCR / L 07	12,50 €
		S16P SDQCR / L 07	15,10 €
		S20R SDQCR / L 07	15,70 €
		S16P SDQCR / L 11	15,10 €
		S20R SDQCR / L 11	15,70 €
		S25S SDQCR / L 11-Z	17,20 €
		S25S SDQCR / L 11	21,80 €
		S32T SDQCR / L 11	30,60 €
		S40U SDQCR / L 11	45,50 €
		A10H SDQCR / L 07	14,20 €
		A12H SDQCR / L 07	15,10 €
		A16M SDQCR / L 07	17,70 €
		A20P SDQCR / L 07	19,20 €
		A16M SDQCR / L 11	17,70 €
		A20P SDQCR / L 11	19,20 €
		A25R SDQCR / L 11	24,80 €
		A32S SDQCR / L 11	34,10 €
 <p>93°</p>	SDUCR / L DC.T 0702.. DC.T 11T3..	S0810K SDUCR / L 07	11,60 €
		S10K SDUCR / L 07	11,60 €
		S12K SDUCR / L 07	12,50 €
		S1216P SDUCR / L 07	15,10 €
		S1416P SDUCR / L 07	15,10 €
		S16P SDUCR / L 07	15,10 €
		S20R SDUCR / L 07	15,70 €
		S1416P SDUCR / L 11	15,10 €
		S16P SDUCR / L 11	15,10 €
		S1620R SDUCR / L 11	15,70 €
		S20R SDUCR / L 11	15,70 €
		S25S SDUCR / L 11-Z	17,20 €
		S25S SDUCR / L 11	21,80 €
		S32T SDUCR / L 11	30,60 €
		S40U SDUCR / L 11	45,50 €
		S50V SDUCR / L 11	57,30 €
		A0810H SDUCR / L 07	14,20 €
		A10H SDUCR / L 07	14,20 €
		A12H SDUCR / L 07	15,10 €
		A16M SDUCR / L 07	17,70 €
		A20P SDUCR / L 07	19,20 €
		A16M SDUCR / L 11	17,70 €
		A20P SDUCR / L 11	19,20 €
		A25R SDUCR / L 11	24,80 €
A32S SDUCR / L 11	34,10 €		





S - TİP SAĞ-SOL DELİK İÇİ TORNA KATERLERİ		FİYATI
 <p>SDXCR / L DC.T 0702.. DC.T 11T3..</p> <p>93°</p>	S12K SDXCR / L 07	12,50 €
	S16P SDXCR / L 07	15,10 €
	S20R SDXCR / L 07	15,70 €
	S16P SDXCR / L 11	15,10 €
	S20R SDXCR / L 11	15,70 €
	S25S SDXCR / L 11-Z	17,20 €
	S25S SDXCR / L 11	21,80 €
	S32T SDXCR / L 11	30,60 €
	S40U SDXCR / L 11	45,50 €
	YENİ A12H SDXCR/L 07	15,10 €
	YENİ A16M SDXCR/L 07	17,70 €
	YENİ A16M SDXCR/L 11	17,70 €
	YENİ A20P SDXCR/L 07	19,20 €
	YENİ A20P SDXCR/L 11	19,20 €
YENİ A25R SDXCR/L 11	24,80 €	
YENİ A32S SDXCR/L 11	34,10 €	
 <p>SRGCR / L RC.T 0803..</p> <p>1°</p>	S16P SRGCR / L 08	30,00 €
	S20R SRGCR / L 08	31,30 €
	S25S SRGCR / L 08C	42,70 €
	S32T SRGCR / L 08C	61,20 €
	S40U SRGCR / L 08C	89,70 €
	YENİ A16M SRGCR/L 08	17,70 €
	YENİ A20P SRGCR/L 08	19,20 €
	YENİ A25R SRGCR/L 08C	24,80 €
	YENİ A32S SRGCR/L 08C	34,10 €
	YENİ A40T SRGCR/L 08C	54,80 €
 <p>SSSCR / L SC.T 09T3.. SC.T 1204..</p> <p>45°</p>	S16P SSSCR / L 09	15,10 €
	S20R SSSCR / L 09	15,70 €
	S25S SSSCR / L 09	21,80 €
	S25S SSSCR / L 09-Z	17,20 €
	S25S SSSCR / L 12	21,80 €
	S32T SSSCR / L 12	30,60 €
	S40U SSSCR / L 12	45,50 €
 <p>ST-CR / L TC.T 1102.. TC.T 16T3..</p> <p>60°</p>	S12K ST-CR / L 11	12,50 €
	S16P ST-CR / L 11	15,10 €
	S20R ST-CR / L 11	15,70 €
	S16P ST-CR / L 16	15,10 €
	S20R ST-CR / L 16	15,70 €
	S25S ST-CR / L 16-Z	17,20 €
	S25S ST-CR / L 16	21,80 €
	S32T ST-CR / L 16	30,60 €
	S40U ST-CR / L 16	45,50 €

S - TİP SAĞ-SOL DELİK İÇİ TORNA KATERLERİ		FİYATI		
 <p>90°</p>	STFCR / L TC.T 06T1.. TC.T 0902.. TC.T 1102.. TC.T 16T3..	S0610F STFCR / L 06 12,90 € S08H STFCR / L 06 11,20 € S10K STFCR / L 09 11,60 € S12K STFCR / L 09 12,50 € S12K STFCR / L 11 12,50 € S16P STFCR / L 11 15,10 € S20R STFCR / L 11 15,70 € S16P STFCR / L 16 15,10 € S20R STFCR / L 16 15,70 € S25S STFCR / L 16-Z 17,20 € S25S STFCR / L 16 21,80 € S32T STFCR / L 16 30,60 € S40U STFCR / L 16 45,50 € YENİ A10H STFCR/L 11 14,20 € YENİ A12H STFCR/L 11 15,10 € YENİ A16M STFCR/L 11 17,70 €		
	 <p>93°</p>	STUCR / L TC.T 0902.. TC.T 1102.. TC.T 16T3..	S10K STUCR / L 09 11,60 € S12K STUCR / L 09 12,50 € S12K STUCR / L 11 12,50 € S16P STUCR / L 11 15,10 € S20R STUCR / L 11 15,70 € S16P STUCR / L 16 15,10 € S20R STUCR / L 16 15,70 € S25S STUCR / L 16-Z 17,20 € S25S STUCR / L 16 21,80 € S32T STUCR / L 16 30,60 € S40U STUCR / L 16 45,50 € YENİ A10H STUCR/L 09 14,20 € YENİ A12H STUCR/L 09 15,10 € YENİ A12H STUCR/L 11 15,10 € YENİ A16M STUCR/L 11 17,70 € YENİ A16M STUCR/L 16 17,70 € YENİ A20P STUCR/L 11 19,20 € YENİ A20P STUCR/L 16 19,20 € YENİ A25R STUCR/L 16 24,80 € YENİ A32S STUCR/L 16 34,10 €	
		 <p>93°</p>	STUPR / L TP.. 0802.. TP.. 1103..	S08H STUPR / L 0802 11,90 € S10K STUPR / L 1103 12,90 € S12K STUPR / L 1103 11,60 € S12M STUPR / L 1103 15,70 € S16P STUPR / L 1103 15,90 € S16R STUPR / L 1103 19,20 € YENİ A20R STUPR/L 1103 19,20 €

S - TİP SAĞ-SOL DELİK İÇİ TORNA KATERLERİ		FİYATI
 <p>SVJBR / L VBM. 1604..</p> <p>93°</p>	S25S SVJBR / L 16	24,80 €
	S32T SVJBR / L 16	30,60 €
	S40U SVJBR / L 16	45,50 €
 <p>SVQBR / L VBM. 1103.. VBM. 1604..</p> <p>107.5°</p>	S16P SVQBR / L 11	17,90 €
	S20R SVQBR / L 11	19,20 €
	S25S SVQBR / L 16-Z	20,90 €
	S25S SVQBR / L 16	24,80 €
	S32T SVQBR / L 16	30,60 €
	S40U SVQBR / L 16	45,50 €
	A20Q SVQBR / L 11	23,50 €
	A20Q SVQBR / L 16	23,50 €
	A25S SVQBR / L 16	31,20 €
	A32S SVQBR / L 16	34,10 €
 <p>SVQCR / L VC.T 1103.. VC.T 1604..</p> <p>107.5°</p>	S16P SVQCR / L 11	17,90 €
	S20R SVQCR / L 11	19,20 €
	S25S SVQCR / L 16-Z	20,90 €
	S25S SVQCR / L 16	24,80 €
	S32T SVQCR / L 16	30,60 €
	S40U SVQCR / L 16	45,50 €
	<small>YENİ</small> A16M SVQCR/L 11	17,70 €
	<small>YENİ</small> A20P SVQCR/L 11	19,20 €
	<small>YENİ</small> A25R SVQCR/L 16	31,20 €
	<small>YENİ</small> A32S SVQCR/L 16	34,10 €
	<small>YENİ</small> A40T SVQCR/L 16	54,80 €
	 <p>SVUBR / L VBM. 1103.. VBM. 1604..</p> <p>93°</p>	S16P SVUBR / L 11
S20R SVUBR / L 11		19,20 €
S25S SVUBR / L 16-Z		20,90 €
S25S SVUBR / L 16		24,80 €
S32T SVUBR / L 16		30,60 €
S40U SVUBR / L 16		45,50 €
A20Q SVUBR / L 16		23,50 €
A32S SVUBR / L 16		34,10 €
 <p>SVUCR / L VC.T 0702.. VC.T 1103.. VC.T 1604..</p> <p>93°</p>	S16P SVUCR / L 11	17,90 €
	S20R SVUCR / L 11	19,20 €
	S25S SVUCR / L 16-Z	20,90 €
	S25S SVUCR / L 16	24,80 €
	S32T SVUCR / L 16	30,60 €
	S40U SVUCR / L 16	45,50 €
	<small>YENİ</small> A12K SVUCR / L 07	16,60 €
	<small>YENİ</small> A20P SVUCR/L 11	19,20 €
	<small>YENİ</small> A20Q SVUCR / L 11	23,50 €
	<small>YENİ</small> A25R SVUCR / L 16	31,20 €

S - TİP SAĞ-SOL DELİK İÇİ TORNA KATERLERİ			FİYATI
 <p>SVXBR / L VBM. 1102.. VBM. 1103.. VBM. 1604..</p> <p>93°</p>	S16P SVXBR / L 1102	24,60 €	
	S20R SVXBR / L 1102	25,90 €	
	S16P SVXBR / L 11	17,90 €	
	S20R SVXBR / L 11	19,20 €	
	S25S SVXBR / L 16	24,80 €	
	S32T SVXBR / L 16	30,60 €	
S40U SVXBR / L 16	45,50 €		
 <p>SVJCR / L VC.T 1103..</p> <p>93°</p>	S12K SVJCR / L 11	15,10 €	
	S16P SVJCR / L 11	17,90 €	
	S20R SVJCR / L 11	19,20 €	
	YENİ A12H SVJCR/L 11	15,10 €	
	YENİ A16M SVJCR/L 11	21,50 €	
YENİ A20P SVJCR/L 11	23,20 €		
 <p>SWLCR WC.. 0302..</p> <p>95°</p>	S0608H SWLCR 03	23,30 €	
	S0810K SWLCR 03	23,30 €	
 <p>SWUBR WBG 060102-L</p> <p>93°</p>	S08H SWUBR 06-5.5	23,30 €	
	S08H SWUBR 06-7	23,30 €	
	S0610H SWUBR 06	23,30 €	



KARBÜR DELİK İÇİ KATERLER			FİYATI
 <p>SCLCR / L CC.T 0602.. CC.T 09T3..</p> <p>95°</p>	YENİ C06J SCLCR/L 06	58,80 €	
	E08K SCLCR / L 06	75,00 €	
	E10M SCLCR / L 06	105,00 €	
	E12Q SCLCR / L 06	150,00 €	
	E16R SCLCR / L 09	210,00 €	
	E20S SCLCR / L 09	360,00 €	
 <p>SDUCR / L DC.T 0702.. DC.T 11T3..</p> <p>93°</p>	E10M SDUCR / L 07	105,00 €	
	E12Q SDUCR / L 07	150,00 €	
	E16R SDUCR / L 11	210,00 €	
	E20S SDUCR / L 11	360,00 €	
 <p>STFCR / L TC.T 0902.. TC.T 1102..</p> <p>90°</p>	E10M STFCR 09	105,00 €	
	E12Q STFCR 09	150,00 €	
	E12Q STFCR 11	150,00 €	

KARBÜR DELİK İÇİ KATERLER			FİYATI
 <p>YENİ</p> <p>93°</p>	STUPR / L TP. 1103..	E12Q STUPR/L 1103 E16R STUPR/L 1103	150,00 € 210,00 €
S-SİSTEM DELİK TORNA KATER SETLERİ			FİYATI
 <p>95°</p>	SET-A/SCLCR / L CC.T 0602.. CC.T 09T3..	A08H SCLCR / L 06 A10H SCLCR / L 06 A12H SCLCR / L 06 A16M SCLCR / L 09	76,10 €
 <p>95°</p>	SET-E/SCLCR / L CC.T 0602.. CC.T 09T3..	E08K SCLCR / L 06 E10M SCLCR / L 06 E12Q SCLCR / L 06 E16R SCLCR / L 09	554,00 €
 <p>95°</p>	SET-S/SCLCR / L CC.T 0602.. CC.T 09T3..	S08H SCLCR / L 06 S10K SCLCR / L 06 S12K SCLCR / L 06 S16P SCLCR / L 09	65,90 €
 <p>93°</p>	SET-A/SDUCR / L DC.T 0702.. DC.T 11T3..	A10H SDUCR / L 07 A12H SDUCR / L 07 A16M SDUCR / L 11	62,50 €
 <p>93°</p>	SET-E/SDUCR / L DC.T 0702.. DC.T 11T3..	E10M SDUCR / L 07 E12Q SDUCR / L 07 E16R SDUCR / L 11	479,00 €
 <p>93°</p>	SET-S/SDUCR / L DC.T 0702.. DC.T 11T3..	S10K SDUCR / L 07 S12K SDUCR / L 07 S16P SDUCR / L 11	54,70 €

TIRLAMAZ TAKIMLAR

38/39

TIRLAMAZ TAKIM GÖVDELERİ		FİYATI
	ATTB-D16-156-7D-H	455,00 €
	ATTB-D16-204-10D-H-E	800,00 €
	ATTB-D20-200-7D-H	450,00 €
	ATTB-D20-260-10D-H-E	785,00 €
	ATTB-D25-255-7D-H	440,00 €
	ATTB-D25-330-10D-H	770,00 €
	ATTB-D32-320-7D-H	505,00 €
	ATTB-D32-416-10D-H	880,00 €
	ATTB-D40-408-7D-H	570,00 €
	ATTB-D40-528-10D-H	1,000,00 €
	ATTB-D50-519-7D-H	705,00 €
	ATTB-D50-669-10D-H	1,225,00 €
	ATTB-D60-628-7D-H	835,00 €
ATTB-D60-808-10D-H	1,460,00 €	

TIRLAMAZ TAKIM KARTUŞLARI		FİYATI	
 <p>93°</p>	SDUCR / L	ATTC-A16 SDUCR/L 07	90,00 €
	DC.T 0702..	ATTC-A20 SDUCR/L 11	95,00 €
	DC.T 11T3..	ATTC-A25 SDUCR/L 11	120,00 €
		ATTC-A32 SDUCR/L 11	135,00 €
		ATTC-A40 SDUCR/L 11	140,00 €
 <p>95°</p>	SCLCR / L	ATTC-A16 SCLCR/L 06	90,00 €
	CC.T 0602..	ATTC-A20 SCLCR/L 09	95,00 €
	CC.T 09T3..	ATTC-A25 SCLCR/L 09	120,00 €
	CC.T 1204..	ATTC-A32 SCLCR/L 09	135,00 €
		ATTC-A40 SCLCR/L 12	140,00 €
 <p>93°</p>	SVUCR / L	ATTC-A20 SVUCR/L 11	95,00 €
	VC.T 1103..	ATTC-A25 SVUCR/L 11	120,00 €
	VC.T 1604..	ATTC-A32 SVUCR/L 16	135,00 €
		ATTC-A40 SVUCR/L 16	140,00 €
 <p>93°</p>	TDUNR / L	ATTC-A32 TDUNR/L 11	135,00 €
	DNM. 1104..	ATTC-A40 TDUNR/L 15	140,00 €
	DNM. 1506..		



TIRLAMAZ TAKIM KARTUŞLARI**FİYATI**

		FİYATI	
 95°	TCLNR / L	ATTC-A32 TCLNR/L 12	135,00 €
	CNM. 1204..	ATTC-A40 TCLNR/L 12	140,00 €





MERKEZLEME APARATI**FİYATI**





		FİYATI	
 1°	ATTC	ATTC-16-25	30,00 €
		ATTC-32-60	40,00 €

Sipariş Örneği: 1 ad. ATTC-A32 TCLNR 12





KARTUŞLAR		FİYATI	
 <p>90°</p>	SCACR / L CC.T 0602.. CC.T 09T3.. CC.T 1204..	S10X SCACR / L 06	13,40 €
		S10A SCACR / L 06	13,40 €
		S1018 SCACR / L 06	13,40 €
		S1065 SCACR / L 06	13,40 €
		S10C SCACR / L 06	13,40 €
		S12B SCACR / L 06	14,20 €
		S12D SCACR / L 06	16,60 €
		S12D SCACR / L 09	19,80 €
		S1265 SCACR / L 09	19,80 €
		S12H SCACR / L 09	19,80 €
		S15C SCACR / L 09	16,60 €
		YENİ S1554 SCACR / L 09	16,60 €
		S15E SCACR / L 09	16,60 €
		S15D SCACR / L 09	16,60 €
		S16A SCACR / L 09	16,60 €
		S16B SCACR / L 09	16,60 €
		S16C SCACR / L 09	16,60 €
		S16D SCACR / L 09	16,60 €
		S16E SCACR / L 09	16,60 €
		S16G SCACR / L 09	16,60 €
		S16H SCACR / L 09	16,60 €
YENİ S1868 SCACR / L 09	19,20 €		
S18E SCACR / L 09	19,20 €		
YENİ S1888 SCACR / L 09	19,20 €		
YENİ S18105 SCACR / L 09	19,20 €		
YENİ S18175 SCACR / L 09	31,20 €		
S20E SCACR / L 09	19,20 €		
S20E SCACR / L 12	19,20 €		
S20H SCACR / L 12	19,20 €		
 <p>50°</p>	SCMCN CC.T 0602.. CC.T 09T3..	S10X SCMCN 06	13,40 €
		YENİ S12D SCMCN 06	16,60 €
		S16C SCMCN 09	16,60 €
		S16D SCMCN 09	16,60 €
 <p>°</p>	SRSCN RC. 10T3	S12D SRSCN 10	16,60 €
		S14D SRSCN 10	16,60 €
		S16D SRSCN 10	16,60 €

KARTUŞLAR			FİYATI
 <p style="text-align: right;">-°</p>	STXCR / L	STXCR / L 2020 B16	22,00 €
	TC.T 16T3..	STXCR / L 2020 E16	22,00 €
		STXCR / L 2020 B16-SA	22,00 €
		STXCR / L 2020 E16-SA	22,00 €
		STXCR / L 2020 B16-PL	22,00 €
		STXCR / L 2020 E16-PL	22,00 €
		STXCR / L 2020 H16-PL	22,00 €
 <p style="text-align: right;">90°</p>	SCFCR / L	SCFCR / L 06CA 06	17,70 €
	CC.T 0602.. CC.T 09T3.. CC.T 1204..	SCFCR / L 08CA 06	17,70 €
		SCFCR / L 10CA 09	17,70 €
		SCFCR / L 12CA 12	17,70 €
		SCFCR / L 16CA 12	19,80 €
 <p style="text-align: right;">45°</p>	SCSCR / L	SCSCR / L 06CA 06	17,70 €
	CC.T 0602.. CC.T 09T3.. CC.T 1204..	SCSCR / L 10CA 09	17,70 €
		SCSCR / L 12CA 12	17,70 €
 <p style="text-align: right;">75°</p>	SSKCR / L	SSKCR / L 10CA 09	17,70 €
	SC.T 09T3.. SC.T 1204..	SSKCR / L 12CA 12	17,70 €
 <p style="text-align: right;">90°</p>		CTFPR / L	CTFPR / L 13CS 16
	TP.. 16 TP.. 22	CTFPR / L 15CS 22	25,00 €
 <p style="text-align: right;">45°</p>		CTSPR / L	CTSPR / L 11.5CS 11
	TP.. 11		
 <p style="text-align: right;">95°</p>	MSYNR / L	MSYNR / L 11.5CS 12	25,00 €
	SNM. 1204..	MSYNR / L 16CS 12	25,00 €

KARTUŞLAR			FİYATI			
 <p>90°</p>	STFCR / L TC.T 0902.. TC.T 1102.. TC.T 16T3..	STFCR / L 08CA 09 STFCR / L 10CA 11 STFCR / L 12CA 16 STFCR / L 16CA 16	17,70 € 17,70 € 17,70 € 19,80 €			
	 <p>45°</p>	STSCR / L TC.T 0902.. TC.T 1102.. TC.T 16T3..	STSCR / L 08CA 09 STSCR / L 10CA 11 STSCR / L 12CA 16	17,70 € 17,70 € 17,70 €		
		 <p>60°</p>	STTCR / L TC.T 0902.. TC.T 1102..	STTCR / L 08CA 09 STTCR / L 10CA 11	17,70 € 17,70 €	
			 <p>75°</p>	PSKNR / L SNM. 1204..	PSKNR / L 16CA 12	30,00 €
				 <p>75°</p>	PSRNR / L SNM. 1204..	PSRNR / L 16CA 12
 <p>90°</p>	PTFNR / L TNM. 1604..	PTFNR / L 12CA 16 PTFNR / L 16CA 16	28,40 € 30,00 €			
	 <p>45°</p>	PSDNN SNM. 1204..	S22D PSDNN 12C	43,80 €		

BORU PAHLAMA TAKIMLARI		FİYATI	
	ACPBT	ACPBT-1	194,00 €
		ACPBT-2	194,00 €
		ACPBT-3	194,00 €
		ACPBT-4	194,00 €
		ACPBT-5	194,00 €
		ACPBT-6	194,00 €
		ACPBT-7	194,00 €
		ACPBT-8	194,00 €
	ACPBT	ACPBT-9	194,00 €
		ACPBT-10	194,00 €
BORU PAHLAMA TAKIMLARININ GÖVDESİ		FİYATI	
	ÖTG	ÖTG-K-120-20	116,40 €
BORU PAHLAMA TAKIMLARININ KARTUŞLARI		FİYATI	
	ÖTG-TC.. TC.T 1102.. TC.T 16T3..	ÖTG-TC11-4İL	28,40 €
		ÖTG-TC11-4İR	28,40 €
		ÖTG-TC16-1AL	28,40 €
		ÖTG-TC16-1AR	28,40 €
		ÖTG-TC16-2DL	28,40 €
		ÖTG-TC16-2DR	28,40 €
		ÖTG-TC16-3İL	28,40 €
		ÖTG-TC16-3İR	28,40 €
DIŞ ÇAP DIŞ AÇMA İSVİÇRE TİPİ KAYAR OTOMAT TAKIMLARI		KESİCİ UÇ	FİYATI
	SER / L 1010 K11-S	11 ER / EL	19,80 €
	SER / L 1212 K11-S		20,50 €

DIŞ ÇAP DIŞ AÇMA TAKIMLARI		KESİCİ UÇ	FİYATI
	SER / L 0808 E11		18,10 €
	SER / L 1010 E11	11 ER / L	18,10 €
	SER / L 1212 F11		18,10 €
	SER / L 1616 H11		18,10 €
	SER / L 2020 H11		19,20 €
	SER / L 1616 H16C	16 ER / L	18,10 €
	SER / L 2020 K16C	(0.35-3)	19,20 €
	SER / L 2525 M16C	ISO METRIC	20,50 €
	SER / L 3232 P16C		23,70 €
	SER / L 2525 M22C	22 ER / L	22,80 €
	SER / L 3232 P22C	(3.5-4.5)	26,10 €
	SER / L 4040 S22C	ISO METRIC	40,10 €
	SER / L 2525 M16C-T	16 ER / L (1.5-3) TR	20,50 €
	SER / L 2525 M22C-T	22 ER / L (4-6) TR	22,80 €
	SER / L 2020 K16C-S	SNDVK 166	21,60 €
	SER / L 2525 M16C-S	ER / L 16	22,40 €
	SER / L 3232 P16C-S		26,10 €

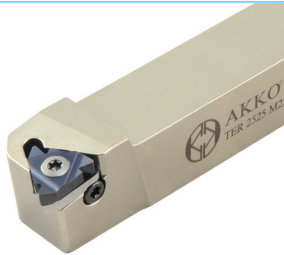

DELİK İÇİ DIŞ AÇMA TAKIMLARI		KESİCİ UÇ	FİYATI	
	SIR / L S12X05H 06	06 IR / L	25,00 €	
	SIR / L S16X05H 06		25,00 €	
	SIR / L S16X07M 08	08 IR / L	17,70 €	
	SIR / L S10H 11		17,70 €	
	SIR / L S12K 11	11 IR / L	17,70 €	
	SIR / L S16X10M 11	ISO	17,70 €	
	SIR / L S16X13M 11		17,70 €	
	SIR / L S16M 11		17,70 €	
	SIR / L S16x13M 16		17,70 €	
	SIR / L S16M 16		17,70 €	
	SIR / L S20x16P 16	16 IR / L	18,10 €	
	SIR / L S20P 16	(0.35-3)	18,10 €	
	SIR / L S25R 16C	ISO METRIC	21,60 €	
	SIR / L S32S 16C		27,40 €	
	SIR / L S40T 16C		34,70 €	
	SIR / L S50U 16C		43,80 €	
	SIR / L S20P 22		18,10 €	
	SIR / L S25R 22C	22 IR / L	22,80 €	
	SIR / L S32S 22C	(3.5-4.5)	30,20 €	
	SIR / L S40T 22C	ISO METRIC	34,70 €	
	SIR / L S50U 22C		43,80 €	
	SIR / L S25R 16C-T	16 IR / L (2-3) TR	21,60 €	
	SIR / L S32S 16C-T	ISO	27,40 €	
	SIR / L S25R 22C-T	22 IR / L (4-6) TR	22,80 €	
	SIR / L S32S 22C-T	ISO	30,20 €	



DIŞ ÇAP DIŞ AÇMA TAKIMLARI		KESİCİ UÇ	FİYATI
	TER / L 1616 H16		20,70 €
	TER / L 2020 K16	16 ER / L	21,80 €
	TER / L 2525 M16	ISO	22,80 €
	TER / L 3232 P16		26,10 €
	TER / L 2525 M22	22 ER / L	26,70 €
	TER / L 3232 P22	ISO	30,20 €
	TER / L 4040 S22		43,80 €
	TER / L 2525 M27	27 ER / L	39,20 €
	TER / L 3232 P27	ISO	42,70 €
	TER / L 4040 S27		56,50 €

DELİK İÇİ DIŞ AÇMA TAKIMLARI		KESİCİ UÇ	FİYATI
	TIR / L S25R 16		23,70 €
	TIR / L S32S 16	16 IR / L	30,00 €
	TIR / L S40T 16	ISO	37,30 €
	TIR / L S50U 16		46,30 €
	TIR / L S25R 22		26,70 €
	TIR / L S32S 22	22 IR / L	33,80 €
	TIR / L S40T 22	ISO	38,80 €
	TIR / L S50U 22		47,60 €
	TIR / L S32S 27	27 IR / L	46,30 €
	TIR / L S40T 27	ISO	51,30 €
	TIR / L S50U 27		59,90 €
	YENİ TIR/L A25R 16	16 IR / L	30,80 €
	YENİ TIR/L A32S 16	ISO	37,50 €
	YENİ TIR/L A40T 16		46,60 €

DIŞ ÇAP KANAL KATERLERİ		KESİCİ UÇ	FİYATI
	ADKT-KG-R/L-2020-2-T15	KG.. - 2	31,30 €
	YENİ ADKT-KG-R/L-2525-2-T8	KG.. - 2	31,50 €
	ADKT-KG-R/L-2525-2-T15	KG.. - 2	31,50 €
	ADKT-KG-R/L-2525-2-T17	KG.. - 2	31,50 €
	ADKT-KG-R/L-1616-3-T20	KG.. - 3	31,00 €
	ADKT-KG-R/L-2020-3-T20	KG.. - 3	31,30 €
	YENİ ADKT-KG-R/L-2525-3-T10	KG.. - 3	31,50 €
	YENİ ADKT-KG-R/L-2525-3-T13	KG.. - 3	31,50 €
	ADKT-KG-R/L-2525-3-T22	KG.. - 3	31,50 €
	ADKT-KG-R/L-2020-4-T20	KG.. - 4	31,30 €
	YENİ ADKT-KG-R/L-2525-4-T10	KG.. - 4	31,50 €
	ADKT-KG-R/L-2525-4-T16	KG.. - 4	31,50 €
	ADKT-KG-R/L-2525-4-T22	KG.. - 4	31,50 €
	YENİ ADKT-KG-R/L-2525-5-T12	KG.. - 5	31,50 €
	YENİ ADKT-KG-R/L-2525-5-T15	KG.. - 5	31,50 €
	YENİ ADKT-KG-R/L-2525-5-T25	KG.. - 5	31,50 €
YENİ ADKT-KG-R/L-2525-6-T25	KG.. - 6	31,50 €	

KRLY
UCUNA UYGUNDUR.

DIŞ ÇAP KANAL KATERLERİ		KESİCİ UÇ	FİYATI
 <p>KRLY - JD UCUNA UYGUNDUR.</p>	YENİ ADKT-K-R/L-1212-1.5-T15	MGM. - 1.5	28,40 €
	YENİ ADKT-K-R/L-2020-1.5-T15	MGM. - 1.5	28,40 €
	ADKT-K-R/L-1212-2-T15	MGM. - 2	28,00 €
	YENİ ADKT-K-R/L-1616-2-T10	MGM. - 2	28,20 €
	ADKT-K-R/L-1616-2-T15	MGM. - 2	28,20 €
	ADKT-K-R/L-2020-2-T15	MGM. - 2	28,40 €
	ADKT-K-R/L-2525-2-T15	MGM. - 2	28,70 €
	ADKT-K-R/L-3232-2-T15	MGM. - 2	34,10 €
	ADKT-K-R/L-1212-3-T15	MGM. - 3	28,00 €
	ADKT-K-R/L-1616-3-T15	MGM. - 3	28,20 €
	YENİ ADKT-K-R/L-2020-3-T10	MGM. - 3	28,40 €
	ADKT-K-R/L-2020-3-T20	MGM. - 3	28,40 €
	ADKT-K-R/L-2020-3-R28	MGM. - 3	37,10 €
	YENİ ADKT-K-R/L-2525-3-T10	MGM. - 3	28,70 €
	ADKT-K-R/L-2525-3-R15	MGM. - 3	28,70 €
	ADKT-K-R/L-2525-3-T22	MGM. - 3	28,70 €
	YENİ ADKT-K-R/L-3232-3-T10	MGM. - 3	34,10 €
	ADKT-K-R/L-3232-3-T22	MGM. - 3	34,10 €
	YENİ ADKT-K-R/L-2020-4-T10	MGM. - 4	28,40 €
	ADKT-K-R/L-2020-4-T20	MGM. - 4	28,40 €
	ADKT-K-R/L-2020-4-R25	MGM. - 4	34,10 €
	YENİ ADKT-K-R/L-2525-4-T10	MGM. - 4	28,70 €
	ADKT-K-R/L-2525-4-T18	MGM. - 4	28,70 €
	ADKT-K-R/L-2525-4-T22	MGM. - 4	28,70 €
	YENİ ADKT-K-R/L-3232-4-T10	MGM. - 4	34,10 €
	ADKT-K-R/L-3232-4-T22	MGM. - 4	34,10 €
	ADKT-K-R/L-2020-5-T20	MGM. - 5	28,40 €
	YENİ ADKT-K-R/L-2525-5-T15	MGM. - 5	28,70 €
	ADKT-K-R/L-2525-5-T18	MGM. - 5	28,70 €
	ADKT-K-R/L-2525-5-T25	MGM. - 5	28,70 €
YENİ ADKT-K-R/L-3232-5-T15	MGM. - 5	34,10 €	
ADKT-K-R/L-3232-5-T25	MGM. - 5	34,10 €	
YENİ ADKT-K-R/L-2525-6-T15	MGM. - 6	28,70 €	
ADKT-K-R/L-2525-6-T25	MGM. - 6	28,70 €	
ADKT-K-R/L-3232-6-T25	MGM. - 6	34,10 €	
ADKT-K-R/L-3232-8-T32	MGM. - 8	39,90 €	
 <p>SMTM UCUNA UYGUNDUR.</p>	ADKT-SGC-R/L-1212-2-R15	GCM N20	30,80 €
	ADKT-SGC-R/L-1616-2-R15	GCM N20	31,00 €
	ADKT-SGC-R/L-2020-2-R20	GCM N20	31,30 €
	ADKT-SGC-R/L-2525-2-R20	GCM N20	31,50 €
	ADKT-SGC-R/L-1212-3-R15	GCM N30	30,80 €
	ADKT-SGC-R/L-1616-3-R15	GCM N30	31,00 €
	ADKT-SGC-R/L-2020-3-R22	GCM N30	31,30 €
	ADKT-SGC-R/L-2525-3-R15	GCM N30	31,50 €
	ADKT-SGC-R/L-2525-3-R22	GCM N30	31,50 €
	ADKT-SGC-R/L-2525-4-R25	GCM N40	31,50 €



DIŞ ÇAP KANAL KATERLERİ		KESİCİ UÇ	FİYATI
	ADKT-H-R/L-2020-3-T20	S229 - 3	28,40 €
	ADKT-H-R/L-2525-3-T22	S229 - 3	28,70 €
	ADKT-H-R/L-2525-3-T26	S229 - 3	31,60 €
	ADKT-H-R/L-2020-4-T20	S229 - 4	28,40 €
	ADKT-H-R/L-2525-4-T22	S229 - 4	28,70 €
	ADKT-H-R/L-3232-4-T22	S229 - 4	34,10 €
	ADKT-H-R/L-2020-5-T20	S229 - 5	28,40 €
	ADKT-H-R/L-2525-5-T25	S229 - 5	28,70 €
	ADKT-H-R/L-2525-6-T25	S229 - 6	28,70 €
	ADKT-HK-R/L-1616-2-T15	S224 - 2	28,20 €
	ADKT-HK-R/L-2020-2-T15	S224 - 2	28,40 €
	ADKT-HK-R/L-2525-2-T15	S224 - 2	28,70 €
	YENİ ADKT-HK-R/L-1616-3-T15	S224 - 3	28,20 €
	ADKT-HK-R/L-2020-3-T20	S224 - 3	28,40 €
	ADKT-HK-R/L-2525-3-T22	S224 - 3	28,70 €
	ADKT-HK-R/L-2020-4-T20	S224 - 4	28,40 €
	ADKT-HK-R/L-2525-4-T22	S224 - 4	28,70 €
	ADKT-HS223-R/L-2020-2-T15	S223 - 2	28,40 €
	ADKT-HS223-R/L-2020-3-T17	S223 - 3	28,40 €



HRN
UCUNA UYGUNDUR.

HRN
UCUNA UYGUNDUR.

Sipariş Örneği: 1 ad. ADKT-H-R-2020-3-T20







DIŞ ÇAP KANAL KATERLERİ		KESİCİ UÇ	FİYATI
 <p>TGTC UCUNA UYGUNDUR.</p>	ADKT-TD-R/L-1212-2-T15	TD. - 2	30,80 €
	YENİ ADKT-TD-R/L-1616-2-T8	TD. - 2	31,00 €
	ADKT-TD-R/L-1616-2-T15	TD. - 2	31,00 €
	ADKT-TD-R/L-2020-2-T9	TD. - 2	31,30 €
	ADKT-TD-R/L-2020-2-T15	TD. - 2	31,30 €
	YENİ ADKT-TD-R/L-2020-2-T17	TD. - 2	31,30 €
	ADKT-TD-R/L-2020-2-T20	TD. - 2	34,40 €
	YENİ ADKT-TD-R/L-2525-2-T8	TD. - 2	31,50 €
	ADKT-TD-R/L-2525-2-T17	TD. - 2	31,50 €
	ADKT-TD-R/L-1212-3-T15	TD. - 3	30,80 €
	ADKT-TD-R/L-1616-3-T15	TD. - 3	31,00 €
	YENİ ADKT-TD-R/L-2020-3-T12	TD. - 3	31,30 €
	ADKT-TD-R/L-2020-3-T20	TD. - 3	31,30 €
	YENİ ADKT-TD-R/L-2020-3-T25	TD. - 3	37,40 €
	ADKT-TD-R/L-2020-3-T30	TD. - 3	43,50 €
	ADKT-TD-R/L-2525-3-T9	TD. - 3	31,50 €
	YENİ ADKT-TD-R/L-2525-3-T12	TD. - 3	31,50 €
	ADKT-TD-R/L-2525-3-T22	TD. - 3	31,50 €
	ADKT-TD-R/L-2525-3-T25	TD. - 3	34,70 €
	ADKT-TD-R/L-2525-3-T30	TD. - 3	43,80 €
YENİ ADKT-TD-R/L-3232-3-T25	TD. - 3	37,30 €	
YENİ ADKT-TD-R/L-2525-4-T10	TD. - 4	31,50 €	
YENİ ADKT-TD-R/L-2525-4-T15	TD. - 4	31,50 €	
ADKT-TD-R/L-2525-4-T22	TD. - 4	31,50 €	
YENİ ADKT-TD-R/L-2525-4-T25	TD. - 4	34,70 €	
ADKT-TD-R/L-2525-4-T30	TD. - 4	43,80 €	
ADKT-TD-R/L-2525-5-T25	TD. - 5	31,50 €	
 <p>YENİ</p> <p>TGTC UCUNA UYGUNDUR.</p>	ADKT-RD-R/L-1616-2-T17	RD. - 2	31,00 €
	ADKT-RD-R/L-2020-2-T17	RD. - 2	31,30 €
	ADKT-RD-R/L-2525-2-T17	RD. - 2	31,50 €
	ADKT-RD-R/L-1616-3-T20	RD. - 3	31,00 €
	ADKT-RD-R/L-2020-3-T25	RD. - 3	37,40 €
	ADKT-RD-R/L-2525-3-T25	RD. - 3	37,40 €
	ADKT-RD-R/L-2020-4-T30	RD. - 4	43,50 €
	ADKT-RD-R/L-2525-4-T30	RD. - 4	43,80 €
 <p>ISCR UCUNA UYGUNDUR.</p>	ADKT-ITG-R/L-2020-3-T8	TGM. - 3	31,30 €
	ADKT-ITG-R/L-2525-3-T8	TGM. - 3	31,50 €
	ADKT-ITG-R/L-3232-3-T8	TGM. - 3	37,30 €
	ADKT-ITG-R/L-2020-4-T9	TGM. - 4	31,30 €
	ADKT-ITG-R/L-2525-4-T17	TGM. - 4	31,50 €
	ADKT-ITG-R/L-3232-4-T17	TGM. - 4	37,30 €
	ADKT-ITG-R/L-3232-5-T25	TGM. - 5	37,30 €



DIŞ ÇAP KANAL KATERLERİ	KESİCİ UÇ	FİYATI	
 <p>SNDVK UCUNA UYGUNDUR.</p>	ADKT-123-R/L-1212-1.5-R15	123 - 1.5	28,00 €
	ADKT-123-R/L-1616-1.5-R15	123 - 1.5	28,20 €
	ADKT-123-R/L-1616-2-T15	123 - 2	28,20 €
	YENİ ADKT-123-R/L-2020-2-T8	123 - 2	28,40 €
	ADKT-123-R/L-2020-2-T15	123 - 2	28,40 €
	YENİ ADKT-123-R/L-2525-2-T8	123 - 2	28,70 €
	ADKT-123-R/L-2525-2-T15	123 - 2	28,70 €
	ADKT-123-R/L-3232-2-T15	123 - 2	37,30 €
	YENİ ADKT-123-R/L-1616-3-T10	123 - 3	28,20 €
	ADKT-123-R/L-1616-3-T15	123 - 3	28,20 €
	YENİ ADKT-123-R/L-2020-3-T10	123 - 3	28,40 €
	YENİ ADKT-123-R/L-2020-3-T15	123 - 3	28,40 €
	ADKT-123-R/L-2020-3-T20	123 - 3	28,40 €
	YENİ ADKT-123-R/L-2525-3-T10	123 - 3	28,70 €
	YENİ ADKT-123-R/L-2525-3-T15	123 - 3	28,70 €
	ADKT-123-R/L-2525-3-T22	123 - 3	28,70 €
	ADKT-123-R/L-2020-4-T20	123 - 4	28,40 €
	YENİ ADKT-123-R/L-2525-4-T13	123 - 4	28,70 €
	ADKT-123-R/L-2525-4-T22	123 - 4	28,70 €
	ADKT-123-R/L-3232-4-T25	123 - 4	37,30 €
ADKT-123-R/L-2020-5-T20	123 - 5	28,40 €	
ADKT-123-R/L-2525-5-T25	123 - 5	28,70 €	
ADKT-123-R/L-3232-6-T15	123 - 6	37,30 €	
 <p>SNDVK UCUNA UYGUNDUR.</p>	ADKT-151.22-R/L-1616-2-T15	151.2 - 2	28,20 €
	ADKT-151.22-R/L-2020-2-T15	151.2 - 2	28,40 €
	ADKT-151.22-R/L-2525-2-T15	151.2 - 2	28,70 €
	ADKT-151.22-R/L-1616-3-T15	151.2 - 3	28,20 €
	ADKT-151.22-R/L-2020-3-T20	151.2 - 3	28,40 €
	ADKT-151.22-R/L-2525-3-T22	151.2 - 3	28,70 €
	ADKT-151.22-R/L-1616-4-T15	151.2 - 4	28,20 €
	ADKT-151.22-R/L-2020-4-T20	151.2 - 4	28,40 €
	ADKT-151.22-R/L-2525-4-T22	151.2 - 4	28,70 €
	ADKT-151.22-R/L-2020-5-T20	151.2 - 5	28,40 €
	ADKT-151.22-R/L-2525-5-T25	151.2 - 5	28,70 €

Sipariş Örneği: 1 ad. ADKT-123-R-1212-1.5-R15









DIŞ ÇAP KANAL KATERLERİ		KESİCİ UÇ	FİYATI
 <p>SNDVK UCUNA UYGUNDUR.</p>	ADKT-151.23-R/L-1616-2-T15	151.2 - 2	28,20 €
	ADKT-151.23-R/L-2020-2-T15	151.2 - 2	28,40 €
	ADKT-151.23-R/L-2525-2-T15	151.2 - 2	28,70 €
	ADKT-151.23-R/L-1616-2.5-T15	151.2 - 2.5	28,20 €
	ADKT-151.23-R/L-2020-2.5-T15	151.2 - 2.5	28,40 €
	ADKT-151.23-R/L-2525-2.5-T15	151.2 - 2.5	28,70 €
	ADKT-151.23-R/L-1212-3-T15	151.2 - 3	28,00 €
	ADKT-151.23-R/L-1616-3-T15	151.2 - 3	28,20 €
	ADKT-151.23-R/L-2020-3-T20	151.2 - 3	28,40 €
	ADKT-151.23-R/L-2525-3-T20	151.2 - 3	28,70 €
	ADKT-151.23-R/L-2525-3-T22	151.2 - 3	28,70 €
	ADKT-151.23-R/L-1616-4-T15	151.2 - 4	28,20 €
	ADKT-151.23-R/L-2020-4-T20	151.2 - 4	28,40 €
	ADKT-151.23-R/L-2525-4-T22	151.2 - 4	28,70 €
	ADKT-151.23-R/L-2020-5-T20	151.2 - 5	28,40 €
ADKT-151.23-R/L-2525-5-T25	151.2 - 5	28,70 €	
 <p>SNDVK UCUNA UYGUNDUR.</p>	ADKT-154.91-R/L-2020-3-T4	154.91 - 3	28,40 €
	ADKT-154.91-R/L 2525-3-T4	154.91 - 3	28,70 €
	ADKT-154.91-R/L 2020-5-T5	154.91 - 5	28,40 €
	ADKT-154.91-R/L 2525-5-T5	154.91 - 5	28,70 €
 <p>ARN UCUNA UYGUNDUR.</p>	ADKT-ARN-R/L-2020-2-T15	LOMR. - 2	28,40 €
	ADKT-ARN-R/L-2525-2-T15	LOMR. - 2	28,70 €
	ADKT-ARN-R/L-2020-3-T20	LOMR. - 3	28,40 €
	ADKT-ARN-R/L-2525-3-T22	LOMR. - 3	28,70 €
 <p>SMTM UCUNA UYGUNDUR.</p>	ADKT-SWC-R/L-2020-2-T25	WCF. - 2	36,40 €
	ADKT-SWC-R/L-2020-3-T25	WCF. - 3	36,40 €

DIŞ ÇAP KANAL KATERLERİ		KESİCİ UÇ	FİYATI
 <p>SMTM UCUNA UYGUNDUR.</p>	ADKT-SGC-R/L-1212-2-R15	GCM N20	30,80 €
	ADKT-SGC-R/L-1616-2-R15	GCM N20	31,00 €
	ADKT-SGC-R/L-2020-2-R20	GCM N20	31,30 €
	ADKT-SGC-R/L-2525-2-R20	GCM N20	31,50 €
	ADKT-SGC-R/L-1212-3-R15	GCM N30	30,80 €
	ADKT-SGC-R/L-1616-3-R15	GCM N30	31,00 €
	ADKT-SGC-R/L-2020-3-R22	GCM N30	31,30 €
	ADKT-SGC-R/L-2525-3-R15	GCM N30	31,50 €
	ADKT-SGC-R/L-2525-3-R22	GCM N30	31,50 €
	ADKT-SGC-R/L-2525-4-R25	GCM N40	31,50 €
 <p>HRN UCUNA UYGUNDUR.</p>	ADKT-H22-R/L-1616-(0.5-2)-T4	S312 - (0.5-2)	28,20 €
	ADKT-H22-R/L-2020-(0.5-2)-T4	S312 - (0.5-2)	28,40 €
	ADKT-H22-R/L-2525-(0.5-2)-T4	S312 - (0.5-2)	28,70 €
 <p>YENİ</p> <p>TNGLY UCUNA UYGUNDUR.</p>	ADKT-TG-R/L-1616-2-R17	DGM2 - 020	31,00 €
	ADKT-TG-R/L-2020-2-R8	DGM2 - 020	31,30 €
	ADKT-TG-R/L-2020-2-R12	DGM2 - 020	31,30 €
	ADKT-TG-R/L-2020-2-R17	DGM2 - 020	31,30 €
	ADKT-TG-R/L-2525-2-R12	DGM2 - 020	31,50 €
	ADKT-TG-R/L-2525-2-R17	DGM2 - 020	31,50 €
	ADKT-TG-R/L-1616-3-T20	DGM3 - 020	31,00 €
	ADKT-TG-R/L-2020-3-T12	DGM3 - 020	31,30 €
	ADKT-TG-R/L-2020-3-T20	DGM3 - 020	31,30 €
	ADKT-TG-R/L-2525-3-T9	DGM3 - 020	31,50 €
	ADKT-TG-R/L-2525-3-T20	DGM3 - 020	31,50 €
	ADKT-TG-R/L-2525-3-R25	DGM3 - 020	34,70 €
	ADKT-TG-R/L-2525-4-T15	DGM4 - 030	31,50 €
	ADKT-TG-R/L-2525-4-T20	DGM4 - 030	31,50 €
	ADKT-TG-R/L-2525-4-T25	DGM4 - 030	34,70 €
ADKT-TG-R/L-2525-5-T12	DGM5 - 030	31,50 €	
ADKT-TG-R/L-2525-5-T25	DGM5 - 030	31,50 €	
ADKT-TG-R/L-2525-5-T32	DGM5 - 030	43,80 €	
 <p>LMNA UCUNA UYGUNDUR.</p>	ADKT-LGC-R/L-1616-2-D40	GCTX - 2	31,00 €
	ADKT-LGC-R/L-2020-2-D40	GCTX - 2	31,30 €
	ADKT-LGC-R/L-2525-2-D40	GCTX - 2	31,50 €
	ADKT-LGC-R/L-1616-3-T20	GCTX - 3	31,00 €
	ADKT-LGC-R/L-2020-3-T20	GCTX - 3	31,30 €
	ADKT-LGC-R/L-2525-3-T20	GCTX - 3	31,50 €

DIŞ ÇAP KANAL KATERLERİ		KESİCİ UÇ	FİYATI
 <p>WLTR UCUNA UYGUNDUR.</p>	ADKT-WGX16-R/L-2020-2-R16	GX16. - 2	31,30 €
	ADKT-WGX16-R/L-2525-2-R16	GX16. - 2	31,50 €
	ADKT-WGX24-R/L-2020-3-T20	GX24. - 3	31,30 €
	ADKT-WGX24-R/L-2525-3-T12	GX24. - 3	31,50 €
	ADKT-WGX24-R/L-2525-3-T22	GX24. - 3	31,50 €
	ADKT-WGX24-R/L-3232-3-T22	GX24. - 3	41,40 €
	ADKT-WGX24-R/L-2525-4-T22	GX24. - 4	31,50 €
	ADKT-WGX24-R/L-2525-5-T25	GX24. - 5	31,50 €
ADKT-WGX24-R/L-3232-5-T25	GX24. - 5	41,40 €	
 <p>PLBT UCUNA UYGUNDUR.</p>	ADKT-GP-R/L-2020-2-T15	GP - 2	31,30 €
	ADKT-GP-R/L-2525-2-T15	GP - 2	31,50 €
	ADKT-GP-R/L-2020-3-T20	GP - 3	31,30 €
	ADKT-GP-R/L-2525-3-T22	GP - 3	31,50 €
	ADKT-GP-R/L-2525-4-T22	GP - 4	31,50 €
	ADKT-GP-R/L-2525-5-T25	GP - 5	31,50 €
 <p>CRTZT UCUNA UYGUNDUR.</p>	ADKT-CD-R/L-2020-3-R20	GX24 0300	31,30 €
	ADKT-CD-R/L-2525-3-R23	GX24 0300	31,50 €



L TİP ALIN KANAL AÇMA TAKIMLARI		KESİCİ UÇ	FİYATI
 <p>ZCC UCUNA UYGUNDUR.</p>	ALKT-ZCC2-R/L-2525-35-45-3-T10	Z.FD - 3	43,80 €
	ALKT-ZCC2-R/L-2525-39-55-3-T10	Z.FD - 3	43,80 €
	ALKT-ZCC2-R/L-2525-35-∅-3-T4	Z.FD - 3	43,80 €
	ALKT-ZCC2-R/L-2525-40-60-4-T14	Z.GD - 4	43,80 €
	ALKT-ZCC2-R/L-2525-52-80-4-T14	Z.GD - 4	43,80 €
	ALKT-ZCC2-R/L-2525-72-110-4-T14	Z.GD - 4	43,80 €
	ALKT-ZCC2-R/L-2525-100-230-4-T14	Z.GD - 4	43,80 €
	ALKT-ZCC2-R/L-2525-40-∅-4-T4	Z.GD - 4	43,80 €



DIŞ ÇAP KANAL AÇMA İSVİÇRE TİPİ KAYAR OTOMAT TAKIMLARI		KESİCİ UÇ	FİYATI
 <p>TGTC UCUNA UYGUNDUR.</p>	ADKT-TD-R/L-1212-2-T12-K-S	TD. - 2	30,80 €
	ADKT-TD-R/L-1616-2-T16-K-S	TD. - 2	31,00 €
	ADKT-TD-R/L-1212-3-T12-K-S	TD. - 3	30,80 €
	ADKT-TD-R/L-1616-3-T16-K-S	TD. - 3	31,00 €
 <p>YENİ</p> <p>TGTC UCUNA UYGUNDUR.</p>	ADKT-RD-R/L-1212-2-T12-K-S	RD. - 2	30,80 €
	ADKT-RD-R/L-1616-2-T17-K-S	RD. - 2	31,00 €
	ADKT-RD-R/L-1212-3-T12-K-S	RD. - 3	30,80 €
 <p>ZCC UCUNA UYGUNDUR.</p>	ADKT-ZCC2-R/L-1010-2-T12-K-S	Z.BD - 2	30,80 €
	ADKT-ZCC2-R/L-1212-2-T12-K-S	Z.BD - 2	30,80 €
	ADKT-ZCC2-R/L-1616-2-R16-K-S	Z.BD - 2	31,00 €
	ADKT-ZCC2-R/L-1212-3-T12-K-S	Z.FD - 3	30,80 €
 <p>KRLY UCUNA UYGUNDUR.</p>	ADKT-KG-R/L-1212-2-R12-K-S	KG. - 2	34,10 €
	ADKT-KG-R/L-1616-2-R16-K-S	KG. - 2	34,30 €
	ADKT-KG-R/L-1212-3-R12-K-S	KG. - 3	34,10 €
	ADKT-KG-R/L-1616-3-R16-K-S	KG. - 3	34,30 €
 <p>YENİ</p> <p>KRLY UCUNA UYGUNDUR.</p>	ADKT-K-R/L-1212-2-R12-K-S	MGM. - 2	30,80 €
	ADKT-K-R/L-1616-2-R16-K-S	MGM. - 2	31,00 €
	ADKT-K-R/L-1212-3-R12-K-S	MGM. - 3	30,80 €
	ADKT-K-R/L-1616-3-R16-K-S	MGM. - 3	31,00 €

DIŞ ÇAP KANAL AÇMA İSVİÇRE TİPİ KAYAR OTOMAT TAKIMLARI		KESİCİ UÇ	FİYATI
 <p>ISCR UCUNA UYGUNDUR.</p>	ADKT-I-R/L-0808-2-R10-S	DGN - 2	30,00 €
	ADKT-I-R/L-1010-2-R10-K-S	DGN - 2	30,80 €
	ADKT-I-R/L-1212-2-R12-K-S	DGN - 2	30,80 €
	ADKT-I-R/L-1616-3-R16-S	DGN - 3	30,80 €
	YENİ ADKT-I-R/L-1616-3-R16-K-S	DGN - 3	31,00 €
 <p>WLTR UCUNA UYGUNDUR.</p>	ADKT-WGX16-R/L-1212-2-R12-K-S	GX16. - 2	30,80 €
	ADKT-WGX16-R/L-1616-2-R16-K-S	GX16. - 2	31,00 €
	YENİ ADKT-WGX24-R/L-1616-3-R16-K-S	GX24. - 3	35,30 €
 <p>YENİ TNGLY UCUNA UYGUNDUR.</p>	ADKT-TG-R/L-1212-2-R12-K-S	DGM2 - 020	30,80 €
	ADKT-TG-R/L-1212-3-R12-K-S	DGM3 - 020	30,80 €
DIŞ ÇAP ALIN KANAL KATERLERİ		KESİCİ UÇ	FİYATI
 <p>KRLY UCUNA UYGUNDUR.</p>	AAKT-K-R/L-2525-34-45-3-T17	MGM. - 3	39,90 €
	AAKT-K-R/L-2525-39-55-3-T17	MGM. - 3	39,90 €
	AAKT-K-R/L-2525-49-80-3-T17	MGM. - 3	39,90 €
	AAKT-K-R/L-2525-70-110-3-T17	MGM. - 3	39,90 €
	AAKT-K-R/L-2525-100-150-3-T17	MGM. - 3	39,90 €
	AAKT-K-R/L-2525-80-180-3-T32	MGM. - 3	47,00 €
	AAKT-K-R/L-2525-175-215-3-T22	MGM. - 3	39,90 €
	AAKT-K-R/L-2525-700-800-3-T17	MGM. - 3	39,90 €
	AAKT-K-R/L-2525-50-85-4-T22	MGM. - 4	39,90 €
	AAKT-K-R/L-2525-70-110-4-T22	MGM. - 4	39,90 €
	AAKT-K-R/L-2525-100-150-4-T22	MGM. - 4	39,90 €
	AAKT-K-R/L-2525-80-180-4-T32	MGM. - 4	47,00 €
	AAKT-K-R/L-2525-180-800-4-T32	MGM. - 4	47,00 €
	AAKT-K-R/L-2525-70-110-5-T25	MGM. - 5	39,90 €
	AAKT-K-R/L-2525-100-150-5-T25	MGM. - 5	39,90 €
	AAKT-K-R/L-2525-140-200-5-T25	MGM. - 5	39,90 €
	AAKT-K-R/L-2525-80-180-5-T32	MGM. - 5	47,00 €
	AAKT-K-R/L-2525-180-800-5-T32	MGM. - 5	47,00 €
	AAKT-K-R/L-2525-60-100-6-T25	MGM. - 6	39,90 €
	AAKT-K-R/L-2525-60-100-6-T35	MGM. - 6	53,00 €
	AAKT-K-R/L-2525-100-200-6-T25	MGM. - 6	39,90 €
	AAKT-K-R/L-2525-100-200-6-T35	MGM. - 6	53,00 €
	YENİ AAKT-K-R/L-2525-100-200-6-T45	MGM. - 6	64,20 €
	AAKT-K-R/L-2525-140-300-6-T35	MGM. - 6	53,00 €
	AAKT-K-R/L-2525-140-300-8-T35	MGM. - 8	60,60 €
AAKT-K-R/L-3232-140-350-8-T35	MGM. - 8	66,20 €	

KESME VE DERİN KANAL AÇMA LAMALARI		KESİCİ UÇ	FİYATI
 <p>YENİ</p> <p>SMTM UCUNA UYGUNDUR.</p>	AKL-SGC-26-3	GCM N30	40,10 €
	AKL-SGC-32-3	GCM N30	42,70 €
 <p>ISCR UCUNA UYGUNDUR.</p>	AKL-I-26-2	DGN - 2	37,70 €
	AKL-I-32-2	DGN - 2	40,10 €
	AKL-I-26-3	DGN - 3	37,70 €
	AKL-I-32-3	DGN - 3	40,10 €
	AKL-I-26-4	DGN / GRP - 4	37,70 €
	AKL-I-32-4	DGN / GRP - 4	40,10 €
 <p>YENİ</p> <p>SNDVK UCUNA UYGUNDUR.</p>	AKL-123-32-2	123 - 2	40,10 €
	AKL-123-32-3	123 - 3	40,10 €
	AKL-123-32-4	123 - 4	40,10 €
 <p>TGTC UCUNA UYGUNDUR.</p>	AKL-TD-32-2	TD. - 2	42,70 €
	AKL-TD-32-3	TD. - 3	42,70 €

KESME VE DERİN KANAL AÇMA LAMA BLOĞU		FİYATI
	ALBU-20-26	42,50 €
	ALBU-20-32	42,50 €
	ALBU-25-26	47,00 €
	ALBU-25-32	47,00 €
	ALBU-32-32	51,70 €

İÇTEN SOĞUTMA KANALLI DIŞ ÇAP KANAL AÇMA TAKIMLARI		KESİCİ UÇ	FİYATI
 <p>YENİ</p> <p>KRLY UCUNA UYGUNDUR.</p>	ADKT-K-R/L-2020-3-T20-H	MGM. - 3	56,80 €
	ADKT-K-R/L-2525-3-T22-H	MGM. - 3	57,40 €
	ADKT-K-R/L-2020-4-T20-H	MGM. - 4	56,80 €
	ADKT-K-R/L-2525-4-T22-H	MGM. - 4	57,40 €
	ADKT-K-R/L-2525-5-T25-H	MGM. - 5	57,40 €
 <p>YENİ</p> <p>TGTC UCUNA UYGUNDUR.</p>	ADKT-TD-R/L-2020-3-T30-H	TD. - 3	87,00 €

DELİK İÇİ KANAL KATERLERİ		KESİCİ UÇ	FİYATI
 <p>KRLY - JD UCUNA UYGUNDUR.</p>	AIKT-K-R/L-16-2-T4	MGM. - 2	23,70 €
	AIKT-K-R/L-20-2-T4	MGM. - 2	26,70 €
	AIKT-K-R/L-25-2-T6	MGM. - 2	28,40 €
	AIKT-K-R/L-20-3-T6	MGM. - 3	26,70 €
	AIKT-K-R/L-20-3-T7	MGM. - 3	29,30 €
	AIKT-K-R/L-25-3-T6	MGM. - 3	28,40 €
	AIKT-K-R/L-25-3-T10	MGM. - 3	31,30 €
	AIKT-K-R/L-32-3-T6	MGM. - 3	34,10 €
	AIKT-K-R/L-32-3-T12	MGM. - 3	37,50 €
	AIKT-K-R/L-40-3-T6	MGM. - 3	39,90 €
	AIKT-K-R/L-40-3-T12	MGM. - 3	43,80 €
	AIKT-K-R/L-20-4-T6	MGM. - 4	26,70 €
	AIKT-K-R/L-20-4-T7	MGM. - 4	29,30 €
	AIKT-K-R/L-25-4-T6	MGM. - 4	28,40 €
	AIKT-K-R/L-25-4-T10	MGM. - 4	31,30 €
	AIKT-K-R/L-32-4-T6	MGM. - 4	34,10 €
	AIKT-K-R/L-32-4-T12	MGM. - 4	37,50 €
	AIKT-K-R/L-40-4-T6	MGM. - 4	39,90 €
	AIKT-K-R/L-40-4-T12	MGM. - 4	43,80 €
	AIKT-K-R/L-25-5-T7	MGM. - 5	28,40 €
AIKT-K-R/L-32-5-T7	MGM. - 5	34,10 €	
AIKT-K-R/L-40-5-T7	MGM. - 5	39,90 €	
AIKT-K-R/L-40-5-T12	MGM. - 5	43,80 €	
 <p>KRLY UCUNA UYGUNDUR.</p>	AIKT-KG-R/L-25-2-T7	KG.. - 2	31,30 €
	AIKT-KG-R/L-20-3-T6.5-H	KG.. - 3	35,40 €
	AIKT-KG-R/L-25-3-T7	KG.. - 3	31,30 €
	AIKT-KG-R/L-40-3-T8	KG.. - 3	43,80 €
	AIKT-KG-R/L-25-4-T8	KG.. - 4	31,30 €

DELİK İÇİ KANAL KATERLERİ		KESİCİ UÇ	FİYATI	
 <p>HRN UCUNA UYGUNDUR.</p>	AIKT-H-R/L-25-3-T8	S229 - 3	28,40 €	
	AIKT-H-R/L-32-3-T7	S229 - 3	34,10 €	
	AIKT-H-R/L-40-3-T7	S229 - 3	39,90 €	
	AIKT-H-R/L-25-4-T8	S229 - 4	28,40 €	
	AIKT-H-R/L-32-4-T7	S229 - 4	34,10 €	
	AIKT-H-R/L-40-4-T7	S229 - 4	39,90 €	
	AIKT-H-R/L-25-5-T8	S229 - 5	28,40 €	
	AIKT-H-R/L-32-5-T7	S229 - 5	34,10 €	
	AIKT-H-R/L-40-5-T7	S229 - 5	39,90 €	
 <p>HRN UCUNA UYGUNDUR.</p>	AIKT-HK-R/L-20-2-T6	S224 - 2	26,70 €	
	AIKT-HK-R/L-25-2-T6	S224 - 2	28,40 €	
	AIKT-HK-R/L-20-3-T6	S224 - 3	26,70 €	
	AIKT-HK-R/L-25-3-T6	S224 - 3	28,40 €	
	AIKT-HK-R/L-32-3-T6	S224 - 3	34,10 €	
	AIKT-HK-R/L-20-4-T6	S224 - 4	26,70 €	
	AIKT-HK-R/L-25-4-T6	S224 - 4	28,40 €	
	AIKT-HK-R/L-32-4-T6	S224 - 4	34,10 €	
	AIKT-HS223-R/L-20-2-T5	S223 - 2	26,70 €	
	AIKT-HS223-R/L-25-2-T5	S223 - 2	28,40 €	
	AIKT-HS223-R/L-20-3-T6	S223 - 3	26,70 €	
AIKT-HS223-R/L-25-3-T6	S223 - 3	28,40 €		
 <p>SNDVK UCUNA UYGUNDUR.</p>	AIKT-154.91-R/L-16-3-T3	154.91 - 3	23,70 €	
	AIKT-154.91-R/L-20-3-T4	154.91 - 3	26,70 €	
	AIKT-154.91-R/L-25-3-T4	154.91 - 3	28,40 €	
	AIKT-154.91-R/L-25-5-T5	154.91 - 5	28,40 €	
	AIKT-154.91-R/L-32-5-T5	154.91 - 5	34,10 €	
 <p>HRN UCUNA UYGUNDUR.</p>	AIKT-ZCC2-R/L-16-2-T4	Z.BD - 2	23,70 €	
	AIKT-ZCC2-R/L-20-3-T5	Z.FD - 3	26,70 €	
	AIKT-ZCC2-R/L-20-3-T8	Z.FD - 3	29,30 €	
	AIKT-ZCC2-R/L-25-3-T5	Z.FD - 3	28,40 €	
	AIKT-ZCC2-R/L-25-3-T10	Z.FD - 3	31,30 €	
	AIKT-ZCC2-R/L-32-3-T6	Z.FD - 3	34,10 €	
	AIKT-ZCC2-R/L-32-3-T8	Z.FD - 3	37,50 €	
	AIKT-ZCC2-R/L-32-3-T13	Z.FD - 3	41,30 €	
	AIKT-ZCC2-R/L-40-3-T12	Z.FD - 3	43,80 €	
	AIKT-ZCC2-R/L-25-4-T6	Z.GD - 4	28,40 €	
	AIKT-ZCC2-R/L-32-4-T7	Z.GD - 4	34,10 €	
	AIKT-ZCC2-R/L-32-4-T8	Z.GD - 4	37,50 €	
	AIKT-ZCC2-R/L-32-4-T10	Z.GD - 4	37,50 €	
	AIKT-ZCC2-R/L-32-5-T7	Z.HD - 5	34,10 €	
	AIKT-ZCC2-R/L-32-5-T8	Z.HD - 5	37,50 €	
	AIKT-ZCC2-R/L-40-5-T8	Z.HD - 5	39,90 €	
	AIKT-ZCC2-R/L-40-5-T10	Z.HD - 5	43,80 €	

DELİK İÇİ KANAL KATERLERİ		KESİCİ UÇ	FİYATI
 <p>ISCR UCUNA UYGUNDUR.</p>	AIKT-IGE-R/L-10-2-T3-H	GEPI - 2	38,80 €
	YENI AIKT-IGE-R/L-16-2-T3-D11.5	GEPI - 2	42,70 €
	AIKT-IGE-R/L-16-2-T2.5-H	GEPI - 2	42,70 €
	AIKT-IGE-R/L-16-3-T2.5-H	GEPI - 3	42,70 €
	AIKT-IGE-R/L-16-3-T2.5-D20	GEPI - 3	38,80 €
 <p>KNMTL UCUNA UYGUNDUR.</p>	AIKT-KM-R/L-20-2-T7	A4. - 2	26,70 €
	AIKT-KM-R/L-20-3-T7	A4. - 3	26,70 €
	AIKT-KM-R/L-25-3-T10	A4. - 3	28,40 €
	AIKT-KM-R/L-32-3-T12	A4. - 3	34,10 €
	AIKT-KM-R/L-40-3-T12	A4. - 3	39,90 €
	YENI AIKT-KM-R/L-20-4-T7	A4. - 4	26,70 €
YENI AIKT-KM-R/L-32-4-T12.2-H	A4. - 4	40,90 €	
 <p>YENI</p> <p>TGTC UCUNA UYGUNDUR.</p>	AIKT-RD-R/L-16-2-T6	RD. - 2	25,80 €
	AIKT-RD-R/L-20-2-T6	RD. - 2	28,50 €
	AIKT-RD-R/L-25-2-T6	RD. - 2	31,40 €
	AIKT-RD-R/L-16-3-T6	RD. - 3	25,80 €
	AIKT-RD-R/L-20-3-T6	RD. - 3	28,50 €
	AIKT-RD-R/L-25-3-T6	RD. - 3	31,40 €
	AIKT-RD-R/L-32-3-T6	RD. - 3	37,80 €
	AIKT-RD-R/L-20-4-T6	RD. - 4	28,50 €
	AIKT-RD-R/L-25-4-T6	RD. - 4	31,40 €
AIKT-RD-R/L-32-4-T6	RD. - 4	37,80 €	
 <p>TGTC UCUNA UYGUNDUR.</p>	AIKT-TD-R/L-16-2-T8.5-H	TD. - 2	28,40 €
	AIKT-TD-R/L-20-3-T6-H	TD. - 3	31,30 €
	AIKT-TD-R/L-25-3-T6-H	TD. - 3	34,50 €
	AIKT-TD-R/L-32-3-T5-H	TD. - 3	41,60 €
 <p>ISCR UCUNA UYGUNDUR.</p>	AIKT-ITG-R/L-16-3-T6-H	TGM. - 3	28,40 €
	AIKT-ITG-R/L-20-3-T6-H	TGM. - 3	31,30 €
	AIKT-ITG-R/L-25-3-T8-H	TGM. - 3	34,50 €
	AIKT-ITG-R/L-32-3-T8-H	TGM. - 3	41,60 €
	AIKT-ITG-R/L-20-4-T6-H	TGM. - 4	31,30 €
	AIKT-ITG-R/L-25-4-T7-H	TGM. - 4	34,50 €
	AIKT-ITG-R/L-25-4-T9-H	TGM. - 4	36,40 €
	AIKT-ITG-R/L-32-4-T11-H	TGM. - 4	41,60 €
	AIKT-ITG-R/L-40-4-T11-H	TGM. - 4	86,20 €
	AIKT-ITG-R/L-32-6.35-T17.5-H	TGM. - 6.35	56,90 €

DELİK İÇİ KANAL KATERLERİ		KESİCİ UÇ	FİYATI
 <p>ISCR UCUNA UYGUNDUR.</p>	AIKT-IG-R/L-25-4-T10-H	DGN / GRP - 4	34,50 €
	AIKT-IG-R/L-32-4-T10-H	DGN / GRP - 4	41,60 €
	AIKT-IG-R/L-40-4-T12-H	DGN / GRP - 4	86,20 €
	AIKT-IG-R/L-25-5-T10-H	DGN / GRP - 5	34,50 €
	AIKT-IG-R/L-32-5-T10-H	DGN / GRP - 5	41,60 €
	AIKT-IG-R/L-40-5-T12-H	DGN / GRP - 5	86,20 €
	AIKT-IG-R/L-50-5-T12-H	DGN / GRP - 5	103,20 €
 <p>ISCR UCUNA UYGUNDUR.</p>	AIKT-IGI-R/L-20-3-T4	GIMIY / GIPI - 3	31,30 €
	AIKT-IGI-R/L-25-3-T5	GIMIY / GIPI - 3	34,50 €
	AIKT-IGI-R/L-32-3-T5	GIMIY / GIPI - 3	41,60 €
	AIKT-IGI-R/L-40-3-T5	GIMIY / GIPI - 3	50,00 €
	AIKT-IGI-R/L-20-4-T4	GIMIY / GIPI - 4	31,30 €
	AIKT-IGI-R/L-25-5-T10	GIMIY / GIPI - 5	34,50 €
	AIKT-IGI-R/L-25-5-T15	GIMIY / GIPI - 5	41,40 €
 <p>ISCR UCUNA UYGUNDUR.</p>	AIKT-I-R/L-20-3-T5	DGN - 3	26,70 €
	AIKT-I-R/L-25-3-T6	DGN - 3	28,40 €
 <p>PLBT UCUNA UYGUNDUR.</p>	AIKT-GP-R/L-20-2-T4	GP - 2	29,30 €
	AIKT-GP-R/L-25-2-T6	GP - 2	31,30 €
	AIKT-GP-R/L-20-3-T6	GP - 3	29,30 €
	AIKT-GP-R/L-25-3-T6	GP - 3	31,30 €
	AIKT-GP-R/L-32-3-T6	GP - 3	37,50 €
	AIKT-GP-R/L-20-4-T6	GP - 4	29,30 €
	AIKT-GP-R/L-25-4-T6	GP - 4	31,30 €
	AIKT-GP-R/L-32-4-T6	GP - 4	37,50 €
 <p>SMTM UCUNA UYGUNDUR.</p>	AIKT-SGC-R/L-25-3-T6	GCM N30	31,30 €
	AIKT-SGC-R/L-32-3-T6	GCM N30	51,30 €
	AIKT-SGC-R/L-40-3-T6	GCM N30	59,70 €

DELİK İÇİ KANAL KATERLERİ		KESİCİ UÇ	FİYATI
 <p>SNDVK UCUNA UYGUNDUR.</p>	AIKT-123-R/L-20-2-T6	123 - 2	26,70 €
	AIKT-123-R/L-25-2-T6	123 - 2	28,40 €
	AIKT-123-R/L-32-2-T7	123 - 2	34,10 €
	AIKT-123-R/L-20-3-T6	123 - 3	26,70 €
	AIKT-123-R/L-25-3-T7	123 - 3	28,40 €
	AIKT-123-R/L-32-3-T9	123 - 3	37,50 €
	AIKT-123-R/L-20-4-T8	123 - 4	29,30 €
	AIKT-123-R/L-25-4-T7	123 - 4	28,40 €
	AIKT-123-R/L-32-4-T7	123 - 4	34,10 €
	AIKT-123-R/L-32-4-T10	123 - 4	37,50 €
	AIKT-123-R/L-25-5-T8	123 - 5	28,40 €
AIKT-123-R/L-32-5-T11	123 - 5	37,50 €	
 <p>YENİ</p> <p>TNGLY UCUNA UYGUNDUR.</p>	AIKT-TG-R/L-20-2-T6	DGIM2 - 020	28,50 €
	AIKT-TG-R/L-20-3-T6	DTX3 - 030	28,50 €
	AIKT-TG-R/L-25-3-T8	DTX3 - 030	33,00 €
	AIKT-TG-R/L-32-3-T10	DTX3 - 030	39,70 €
	AIKT-TG-R/L-32-3-T12	DTX3 - 030	41,50 €
	AIKT-TG-R/L-32-4-T10	DTX4 - 040	39,70 €
	AIKT-TG-R/L-32-5-T10	DTX5 - 050	39,70 €
 <p>YENİ</p> <p>ZCC UCUNA UYGUNDUR.</p>	AIKT-QC11-R/L-20-(0.5-1.8)	QC11R/L (0.50-1.80)	29,40 €
	AIKT-QC16-R/L-20-(0.5-1.8)	QC16R/L (0.50-1.80)	29,40 €
	AIKT-QC16-R/L-20-(0.5-2.5)	QC16R/L (0.50-2.50)	29,40 €
	AIKT-QC22-R/L-25-(1-2.3)	QC22R/L (1.00-2.30)	31,30 €
	AIKT-QC22-R/L-25-(2.5-3.3)	QC22R/L (2.50-3.30)	31,30 €
	AIKT-QC22-R/L-25-(3.3-4.8)	QC22R/L (3.30-4.80)	31,30 €
	AIKT-QC22-R/L-32-(1-2.3)	QC22R/L (1.00-2.30)	37,50 €

MİNİ KANAL KATERİ		KESİCİ UÇ	FİYATI
 <p>SNDVK UCUNA UYGUNDUR.</p>	AIKT-MB07-A16-090-15	MB - 07	33,20 €
	AIKT-MB07-A16-090-22	MB - 07	33,20 €
	AIKT-MB09-A16-090-19	MB - 09	33,20 €
	AIKT-MB09-A16-110-40	MB - 09	33,20 €
	AIKT-MB09-A16-095-28	MB - 09	33,20 €

TAKMA UÇLU MATKAPLAR (WCM.) U-DRILL SİSTEMİ

D2

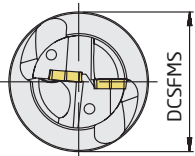
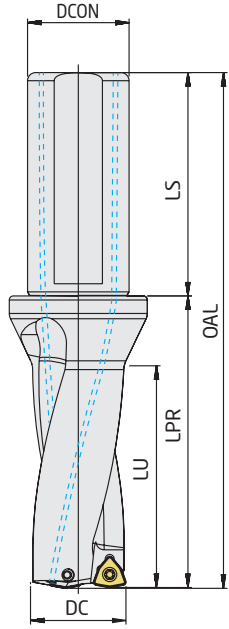

ISO
UCUNA UYGUNDUR.

TAKIM KODU	TAKIM ÖLÇÜLERİ (mm)							KESİCİ UÇ	FİYAT
	DC	DCON	DCSEMS	OAL	LU	LPR	LS		
ATUM 16XD2 WCM. 030208	16	25	34	110	32	54	56	WCM. 030208	65,10 €
ATUM 16.5XD2 WCM. 030208	16,5	25	34	110	32	54	56	WCM. 030208	65,10 €
ATUM 17XD2 WCM. 030208	17	25	34	112	34	56	56	WCM. 030208	65,10 €
ATUM 17.5XD2 WCM. 030208	17,5	25	34	112	34	56	56	WCM. 030208	65,10 €
ATUM 18XD2 WCM. 030208	18	25	34	114	36	58	56	WCM. 030208	65,10 €
ATUM 18.5XD2 WCM. 030208	18,5	25	34	114	36	58	56	WCM. 030208	65,10 €
ATUM 19XD2 WCM. 030208	19	25	34	116	38	60	56	WCM. 030208	65,10 €
ATUM 19.5XD2 WCM. 030208	19,5	25	34	116	38	60	56	WCM. 030208	65,10 €
ATUM 20XD2 WCM. 040208	20	25	34	118	40	62	56	WCM. 040208	69,60 €
ATUM 20.5XD2 WCM. 040208	20,5	25	34	118	40	62	56	WCM. 040208	69,60 €
ATUM 21XD2 WCM. 040208	21	25	34	120	42	64	56	WCM. 040208	69,60 €
ATUM 21.5XD2 WCM. 040208	21,5	25	34	120	42	64	56	WCM. 040208	69,60 €
ATUM 22XD2 WCM. 040208	22	25	34	122	44	66	56	WCM. 040208	69,60 €
ATUM 22.5XD2 WCM. 040208	22,5	25	34	122	44	66	56	WCM. 040208	69,60 €
ATUM 23XD2 WCM. 040208	23	25	34	124	46	68	56	WCM. 040208	69,60 €
ATUM 23.5XD2 WCM. 040208	23,5	25	34	124	46	68	56	WCM. 040208	69,60 €
ATUM 24XD2 WCM. 050308	24	25	34	126	48	70	56	WCM. 050308	71,30 €
ATUM 24.5XD2 WCM. 050308	24,5	25	34	126	48	70	56	WCM. 050308	71,30 €
ATUM 25XD2 WCM. 050308	25	25	34	128	50	72	56	WCM. 050308	71,30 €
ATUM 25.5XD2 WCM. 050308	25,5	25	34	128	50	72	56	WCM. 050308	71,30 €
ATUM 26XD2 WCM. 050308	26	25	34	130	52	74	56	WCM. 050308	71,30 €
ATUM 26.5XD2 WCM. 050308	26,5	25	34	130	52	74	56	WCM. 050308	71,30 €
ATUM 27XD2 WCM. 050308	27	25	34	132	54	76	56	WCM. 050308	71,30 €
ATUM 27.5XD2 WCM. 050308	27,5	25	34	132	54	76	56	WCM. 050308	71,30 €
ATUM 28XD2 WCM. 050308	28	25	34	134	56	78	56	WCM. 050308	71,30 €
ATUM 28.5XD2 WCM. 050308	28,5	25	34	134	56	78	56	WCM. 050308	71,30 €
ATUM 29XD2 WCM. 050308	29	25	34	136	58	80	56	WCM. 050308	71,30 €
ATUM 29.5XD2 WCM. 050308	29,5	25	34	136	58	80	56	WCM. 050308	71,30 €
ATUM 30XD2 WCM. 06T308	30	32	44	147	60	87	60	WCM. 06T308	75,90 €
ATUM 31XD2 WCM. 06T308	31	32	44	149	62	89	60	WCM. 06T308	75,90 €
ATUM 32XD2 WCM. 06T308	32	32	44	151	64	91	60	WCM. 06T308	75,90 €
ATUM 33XD2 WCM. 06T308	33	32	44	153	66	93	60	WCM. 06T308	75,90 €
ATUM 34XD2 WCM. 06T308	34	32	44	155	68	95	60	WCM. 06T308	75,90 €
ATUM 35XD2 WCM. 06T308	35	32	44	157	70	97	60	WCM. 06T308	75,90 €
ATUM 36XD2 WCM. 06T308	36	32	44	159	72	99	60	WCM. 06T308	75,90 €
ATUM 37XD2 WCM. 06T308	37	32	44	161	74	101	60	WCM. 06T308	75,90 €
ATUM 38XD2 WCM. 06T308	38	32	44	163	76	103	60	WCM. 06T308	75,90 €
ATUM 39XD2 WCM. 06T308	39	32	44	165	78	105	60	WCM. 06T308	75,90 €
ATUM 40XD2 WCM. 06T308	40	32	44	167	80	107	60	WCM. 06T308	75,90 €
ATUM 41XD2 WCM. 06T308	41	32	44	169	82	109	60	WCM. 06T308	78,00 €
ATUM 42XD2 WCM. 06T308	42	32	44	171	84	111	60	WCM. 06T308	78,00 €
ATUM 43XD2 WCM. 06T308	43	32	44	173	86	113	60	WCM. 06T308	78,00 €
ATUM 44XD2 WCM. 06T308	44	32	44	175	88	115	60	WCM. 06T308	78,00 €
ATUM 45XD2 WCM. 080412	45	40	54	192	90	122	70	WCM. 080412	85,10 €
ATUM 46XD2 WCM. 080412	46	40	54	194	92	124	70	WCM. 080412	89,00 €
ATUM 47XD2 WCM. 080412	47	40	54	196	94	126	70	WCM. 080412	95,30 €
ATUM 48XD2 WCM. 080412	48	40	54	198	96	128	70	WCM. 080412	99,80 €
ATUM 49XD2 WCM. 080412	49	40	54	200	98	130	70	WCM. 080412	104,30 €
ATUM 50XD2 WCM. 080412	50	40	54	202	100	132	70	WCM. 080412	108,60 €
ATUM 51XD2 WCM. 080412	51	40	54	204	102	134	70	WCM. 080412	112,70 €
ATUM 52XD2 WCM. 080412	52	40	54	206	104	136	70	WCM. 080412	116,80 €
ATUM 53XD2 WCM. 080412	53	40	54	208	106	138	70	WCM. 080412	121,30 €
ATUM 54XD2 WCM. 080412	54	40	54	210	108	140	70	WCM. 080412	126,30 €
ATUM 55XD2 WCM. 080412	55	40	54	212	110	142	70	WCM. 080412	126,30 €
ATUM 56XD2 WCM. 080412	56	40	59	214	112	144	70	WCM. 080412	126,30 €
ATUM 57XD2 WCM. 080412	57	40	59	216	114	146	70	WCM. 080412	134,90 €
ATUM 58XD2 WCM. 080412	58	40	59	218	116	148	70	WCM. 080412	134,90 €
ATUM 59XD2 WCM. 080412	59	40	59	220	118	150	70	WCM. 080412	134,90 €
ATUM 60XD2 WCM. 080412	60	40	59	222	120	152	70	WCM. 080412	134,90 €

TAKMA UÇLU MATKAPLAR (WCM.) U-DRILL SİSTEM

D3	TAKIM KODU	TAKIM ÖLÇÜLERİ (mm)						KESİCİ UÇ	FİYAT	
		DC	DCON	DCSFM	OAL	LU	LPR			LS
	ATUM 16XD3 WCM. 030208	16	25	34	126	48	70	56	WCM. 030208	71,30 €
	ATUM 16.5XD3 WCM. 030208	16.5	25	34	126	48	70	56	WCM. 030208	71,30 €
	ATUM 17XD3 WCM. 030208	17	25	34	129	51	73	56	WCM. 030208	71,30 €
	ATUM 17.5XD3 WCM. 030208	17.5	25	34	129	51	73	56	WCM. 030208	71,30 €
	ATUM 18XD3 WCM. 030208	18	25	34	132	54	76	56	WCM. 030208	71,30 €
	ATUM 18.5XD3 WCM. 030208	18.5	25	34	132	54	76	56	WCM. 030208	71,30 €
	ATUM 19XD3 WCM. 030208	19	25	34	135	57	79	56	WCM. 030208	71,30 €
	ATUM 19.5XD3 WCM. 030208	19.5	25	34	135	57	79	56	WCM. 030208	71,30 €
	ATUM 20XD3 WCM. 040208	20	25	34	138	60	82	56	WCM. 040208	74,10 €
	ATUM 20.5XD3 WCM. 040208	20.5	25	34	138	60	82	56	WCM. 040208	74,10 €
	ATUM 21XD3 WCM. 040208	21	25	34	141	63	85	56	WCM. 040208	74,10 €
	ATUM 21.5XD3 WCM. 040208	21.5	25	34	141	63	85	56	WCM. 040208	74,10 €
	ATUM 22XD3 WCM. 040208	22	25	34	144	66	88	56	WCM. 040208	74,10 €
	ATUM 22.5XD3 WCM. 040208	22.5	25	34	144	66	88	56	WCM. 040208	74,10 €
	ATUM 23XD3 WCM. 040208	23	25	34	147	69	91	56	WCM. 040208	74,10 €
	ATUM 23.5XD3 WCM. 040208	23.5	25	34	147	69	91	56	WCM. 040208	74,10 €
	ATUM 24XD3 WCM. 050308	24	25	34	150	72	94	56	WCM. 050308	75,90 €
	ATUM 24.5XD3 WCM. 050308	24.5	25	34	150	72	94	56	WCM. 050308	75,90 €
	ATUM 25XD3 WCM. 050308	25	25	34	153	75	97	56	WCM. 050308	75,90 €
	ATUM 25.5XD3 WCM. 050308	25.5	25	34	153	75	97	56	WCM. 050308	75,90 €
	ATUM 26XD3 WCM. 050308	26	25	34	156	78	100	56	WCM. 050308	75,90 €
	ATUM 26.5XD3 WCM. 050308	26.5	25	34	156	78	100	56	WCM. 050308	75,90 €
	ATUM 27XD3 WCM. 050308	27	25	34	159	81	103	56	WCM. 050308	75,90 €
	ATUM 27.5XD3 WCM. 050308	27.5	25	34	159	81	103	56	WCM. 050308	75,90 €
	ATUM 28XD3 WCM. 050308	28	25	34	162	84	106	56	WCM. 050308	75,90 €
	ATUM 28.5XD3 WCM. 050308	28.5	25	34	162	84	106	56	WCM. 050308	75,90 €
	ATUM 29XD3 WCM. 050308	29	25	34	165	87	109	56	WCM. 050308	75,90 €
	ATUM 29.5XD3 WCM. 050308	29.5	25	34	165	87	109	56	WCM. 050308	75,90 €
	ATUM 30XD3 WCM. 06T308	30	32	44	177	90	117	60	WCM. 06T308	78,00 €
	ATUM 30.5XD3 WCM. 06T308	30.5	32	44	177	90	117	60	WCM. 06T308	78,00 €
	ATUM 31XD3 WCM. 06T308	31	32	44	180	93	120	60	WCM. 06T308	78,00 €
	ATUM 31.5XD3 WCM. 06T308	31.5	32	44	180	93	120	60	WCM. 06T308	78,00 €
	ATUM 32XD3 WCM. 06T308	32	32	44	183	96	123	60	WCM. 06T308	78,00 €
	ATUM 32.5XD3 WCM. 06T308	32.5	32	44	183	96	123	60	WCM. 06T308	78,00 €
	ATUM 33XD3 WCM. 06T308	33	32	44	186	99	126	60	WCM. 06T308	78,00 €
	ATUM 33.5XD3 WCM. 06T308	33.5	32	44	186	99	126	60	WCM. 06T308	78,00 €
	ATUM 34XD3 WCM. 06T308	34	32	44	189	102	129	60	WCM. 06T308	78,00 €
	ATUM 34.5XD3 WCM. 06T308	34.5	32	44	189	102	129	60	WCM. 06T308	78,00 €
	ATUM 35XD3 WCM. 06T308	35	32	44	192	105	132	60	WCM. 06T308	78,00 €
	ATUM 35.5XD3 WCM. 06T308	35.5	32	44	192	105	132	60	WCM. 06T308	78,00 €
	ATUM 36XD3 WCM. 06T308	36	32	44	195	108	135	60	WCM. 06T308	78,00 €
	ATUM 36.5XD3 WCM. 06T308	36.5	32	44	195	108	135	60	WCM. 06T308	78,00 €
	ATUM 37XD3 WCM. 06T308	37	32	44	198	111	138	60	WCM. 06T308	78,00 €
	ATUM 37.5XD3 WCM. 06T308	37.5	32	44	198	111	138	60	WCM. 06T308	78,00 €
	ATUM 38XD3 WCM. 06T308	38	32	44	201	114	141	60	WCM. 06T308	78,00 €
	ATUM 38.5XD3 WCM. 06T308	38.5	32	44	201	114	141	60	WCM. 06T308	78,00 €
	ATUM 39XD3 WCM. 06T308	39	32	44	204	117	144	60	WCM. 06T308	78,00 €
	ATUM 39.5XD3 WCM. 06T308	39.5	32	44	204	117	144	60	WCM. 06T308	78,00 €
	ATUM 40XD3 WCM. 06T308	40	32	44	207	120	147	60	WCM. 06T308	78,00 €
	ATUM 40.5XD3 WCM. 06T308	40.5	32	44	207	120	147	60	WCM. 06T308	78,00 €
	ATUM 41XD3 WCM. 06T308	41	32	44	210	123	150	60	WCM. 06T308	86,60 €
	ATUM 41.5XD3 WCM. 06T308	41.5	32	44	210	123	150	60	WCM. 06T308	86,60 €
	ATUM 42XD3 WCM. 06T308	42	32	44	213	126	153	60	WCM. 06T308	86,60 €
	ATUM 42.5XD3 WCM. 06T308	42.5	32	44	213	126	153	60	WCM. 06T308	86,60 €
	ATUM 43XD3 WCM. 06T308	43	32	44	216	129	156	60	WCM. 06T308	86,60 €
	ATUM 43.5XD3 WCM. 06T308	43.5	32	44	216	129	156	60	WCM. 06T308	86,60 €
	ATUM 44XD3 WCM. 06T308	44	32	44	219	132	159	60	WCM. 06T308	86,60 €
	ATUM 44.5XD3 WCM. 06T308	44.5	32	44	219	132	159	60	WCM. 06T308	86,60 €

ISO
UCUNA UYGUNDUR.

TAKMA UÇLU MATKAPLAR (WCM.) U-DRILL SİSTEM

	TAKIM KODU	TAKIM ÖLÇÜLERİ (mm)						KESİCİ UÇ	FİYAT	
		DC	DCON	DCSFMS	OAL	LU	LPR			LS
D3  ISO UCUNA UYGUNDUR.	ATUM 45XD3 WCM. 080412	45	40	54	237	135	167	70	WCM. 080412	91,40 €
	ATUM 45.5XD3 WCM. 080412	45.5	40	54	237	135	167	70	WCM. 080412	91,40 €
	ATUM 46XD3 WCM. 080412	46	40	54	240	138	170	70	WCM. 080412	95,30 €
	ATUM 47XD3 WCM. 080412	47	40	54	243	141	173	70	WCM. 080412	99,80 €
	ATUM 48XD3 WCM. 080412	48	40	54	246	144	176	70	WCM. 080412	104,30 €
	ATUM 49XD3 WCM. 080412	49	40	54	249	147	179	70	WCM. 080412	108,60 €
	ATUM 50XD3 WCM. 080412	50	40	54	252	150	182	70	WCM. 080412	116,80 €
	ATUM 51XD3 WCM. 080412	51	40	54	255	153	185	70	WCM. 080412	121,30 €
	ATUM 52XD3 WCM. 080412	52	40	54	258	156	188	70	WCM. 080412	126,30 €
	ATUM 53XD3 WCM. 080412	53	40	54	261	159	191	70	WCM. 080412	130,40 €
	ATUM 54XD3 WCM. 080412	54	40	54	264	162	194	70	WCM. 080412	134,90 €
	ATUM 55XD3 WCM. 080412	55	40	54	267	165	197	70	WCM. 080412	134,90 €
	ATUM 56XD3 WCM. 080412	56	40	59	270	168	200	70	WCM. 080412	134,90 €
	ATUM 57XD3 WCM. 080412	57	40	59	273	171	203	70	WCM. 080412	143,30 €
	ATUM 58XD3 WCM. 080412	58	40	59	276	174	206	70	WCM. 080412	143,30 €
	ATUM 59XD3 WCM. 080412	59	40	59	279	177	209	70	WCM. 080412	143,30 €
	ATUM 60XD3 WCM. 080412	60	40	59	282	180	212	70	WCM. 080412	143,30 €

	TAKIM KODU	TAKIM ÖLÇÜLERİ (mm)						KESİCİ UÇ	FİYAT	
		DC	DCON	DCSFMS	OAL	LU	LPR			LS
D5  YENİ ISO UCUNA UYGUNDUR.	ATUM 20XD5 WCM. 040208	20	25	34	178	100	122	56	WCM. 040208	129,70 €
	ATUM 21XD5 WCM. 040208	21	25	34	183	105	127	56	WCM. 040208	129,70 €
	ATUM 22XD5 WCM. 040208	22	25	34	188	110	132	56	WCM. 040208	129,70 €
	ATUM 23XD5 WCM. 040208	23	25	34	193	115	137	56	WCM. 040208	129,70 €
	ATUM 24XD5 WCM. 050308	24	25	34	198	120	142	56	WCM. 050308	132,80 €
	ATUM 25XD5 WCM. 050308	25	25	34	203	125	147	56	WCM. 050308	132,80 €
	ATUM 26XD5 WCM. 050308	26	25	34	208	130	152	56	WCM. 050308	132,80 €
	ATUM 27XD5 WCM. 050308	27	25	34	213	135	157	56	WCM. 050308	132,80 €
	ATUM 28XD5 WCM. 050308	28	25	34	218	140	162	56	WCM. 050308	132,80 €
	ATUM 29XD5 WCM. 050308	29	25	34	223	145	167	56	WCM. 050308	132,80 €
	ATUM 30XD5 WCM. 06T308	30	32	44	237	150	177	60	WCM. 06T308	136,50 €
	ATUM 31XD5 WCM. 06T308	31	32	44	242	155	182	60	WCM. 06T308	136,50 €
	ATUM 32XD5 WCM. 06T308	32	32	44	247	160	187	60	WCM. 06T308	136,50 €
	ATUM 33XD5 WCM. 06T308	33	32	44	252	165	192	60	WCM. 06T308	136,50 €
	ATUM 34XD5 WCM. 06T308	34	32	44	257	170	197	60	WCM. 06T308	136,50 €
	ATUM 35XD5 WCM. 06T308	35	32	44	262	175	202	60	WCM. 06T308	136,50 €
	ATUM 37XD5 WCM. 06T308	37	32	44	272	185	212	60	WCM. 06T308	136,50 €
	ATUM 38XD5 WCM. 06T308	38	32	44	277	190	217	60	WCM. 06T308	136,50 €
	ATUM 46XD5 WCM. 080412	46	40	54	332	230	262	70	WCM. 080412	166,80 €

TAKMA UÇLU MATKAPLAR (WCM) U-DRILL SİSTEM

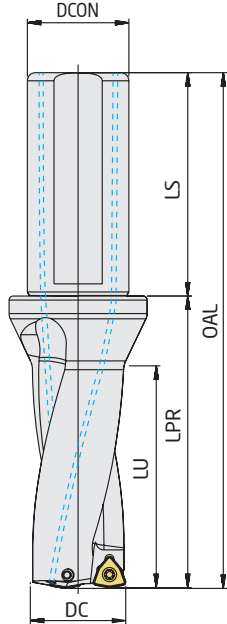
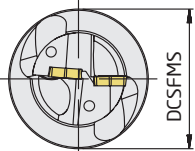
	TAKIM KODU	TAKIM ÖLÇÜLERİ (mm)						KESİCİ UÇ	FİYAT	
		DC	DCON	DCSFMS	OAL	LU	LPR			LS
D4   	ATUM 16XD4 WCM. 030208	16	25	34	142	64	86	56	WCM. 030208	86,20 €
	ATUM 16.5XD4 WCM. 030208	16.5	25	34	142	64	86	56	WCM. 030208	86,20 €
	ATUM 17XD4 WCM. 030208	17	25	34	146	68	90	56	WCM. 030208	86,20 €
	ATUM 17.5XD4 WCM. 030208	17.5	25	34	146	68	90	56	WCM. 030208	86,20 €
	ATUM 18XD4 WCM. 030208	18	25	34	150	72	94	56	WCM. 030208	86,20 €
	ATUM 18.5XD4 WCM. 030208	18.5	25	34	150	72	94	56	WCM. 030208	86,20 €
	ATUM 19XD4 WCM. 030208	19	25	34	154	76	98	56	WCM. 030208	86,20 €
	ATUM 19.5XD4 WCM. 030208	19.5	25	34	154	76	98	56	WCM. 030208	86,20 €
	ATUM 20XD4 WCM. 040208	20	25	34	158	80	102	56	WCM. 040208	89,70 €
	ATUM 20.5XD4 WCM. 040208	20.5	25	34	158	80	102	56	WCM. 040208	89,70 €
	ATUM 21XD4 WCM. 040208	21	25	34	162	84	106	56	WCM. 040208	89,70 €
	ATUM 21.5XD4 WCM. 040208	21.5	25	34	162	84	106	56	WCM. 040208	89,70 €
	ATUM 22XD4 WCM. 040208	22	25	34	166	88	110	56	WCM. 040208	89,70 €
	ATUM 22.5XD4 WCM. 040208	22.5	25	34	166	88	110	56	WCM. 040208	89,70 €
	ATUM 23XD4 WCM. 040208	23	25	34	170	92	114	56	WCM. 040208	89,70 €
	ATUM 23.5XD4 WCM. 040208	23.5	25	34	170	92	114	56	WCM. 040208	89,70 €
	ATUM 24XD4 WCM. 050308	24	25	34	174	96	118	56	WCM. 050308	93,10 €
	ATUM 24.5XD4 WCM. 050308	24.5	25	34	174	96	118	56	WCM. 050308	93,10 €
	ATUM 25XD4 WCM. 050308	25	25	34	178	100	122	56	WCM. 050308	93,10 €
	ATUM 25.5XD4 WCM. 050308	25.5	25	34	178	100	122	56	WCM. 050308	93,10 €
	ATUM 26XD4 WCM. 050308	26	25	34	182	104	126	56	WCM. 050308	93,10 €
	ATUM 26.5XD4 WCM. 050308	26.5	25	34	182	104	126	56	WCM. 050308	93,10 €
	ATUM 27XD4 WCM. 050308	27	25	34	186	108	130	56	WCM. 050308	93,10 €
	ATUM 27.5XD4 WCM. 050308	27.5	25	34	186	108	130	56	WCM. 050308	93,10 €
	ATUM 28XD4 WCM. 050308	28	25	34	190	112	134	56	WCM. 050308	93,10 €
	ATUM 28.5XD4 WCM. 050308	28.5	25	34	190	112	134	56	WCM. 050308	93,10 €
	ATUM 29XD4 WCM. 050308	29	25	34	194	116	138	56	WCM. 050308	93,10 €
	ATUM 29.5XD4 WCM. 050308	29.5	25	34	194	116	138	56	WCM. 050308	93,10 €
	ATUM 30XD4 WCM. 06T308	30	32	44	207	120	147	60	WCM. 06T308	96,60 €
	ATUM 31XD4 WCM. 06T308	31	32	44	211	124	151	60	WCM. 06T308	96,60 €
	ATUM 32XD4 WCM. 06T308	32	32	44	215	128	155	60	WCM. 06T308	96,60 €
	ATUM 33XD4 WCM. 06T308	33	32	44	219	132	159	60	WCM. 06T308	96,60 €
	ATUM 33.5XD4 WCM. 06T308	33.5	32	44	219	132	159	60	WCM. 06T308	96,60 €
	ATUM 34XD4 WCM. 06T308	34	32	44	223	136	163	60	WCM. 06T308	96,60 €
	ATUM 35XD4 WCM. 06T308	35	32	44	227	140	167	60	WCM. 06T308	96,60 €
	ATUM 36XD4 WCM. 06T308	36	32	44	231	144	171	60	WCM. 06T308	96,60 €
	ATUM 37XD4 WCM. 06T308	37	32	44	235	148	175	60	WCM. 06T308	96,60 €
	ATUM 38XD4 WCM. 06T308	38	32	44	239	152	179	60	WCM. 06T308	96,60 €
	ATUM 38.5XD4 WCM. 06T308	38.5	32	44	239	152	179	60	WCM. 06T308	96,60 €
	ATUM 39XD4 WCM. 06T308	39	32	44	243	156	183	60	WCM. 06T308	96,60 €
	ATUM 40XD4 WCM. 06T308	40	32	44	247	160	187	60	WCM. 06T308	96,60 €
	ATUM 41XD4 WCM. 06T308	41	32	44	251	164	191	60	WCM. 06T308	103,20 €
	ATUM 42XD4 WCM. 06T308	42	32	44	255	168	195	60	WCM. 06T308	103,20 €
	ATUM 43XD4 WCM. 06T308	43	32	44	259	172	199	60	WCM. 06T308	103,20 €
	ATUM 44XD4 WCM. 06T308	44	32	44	263	176	203	60	WCM. 06T308	103,20 €
	ATUM 45XD4 WCM. 080412	45	40	54	282	180	212	70	WCM. 080412	110,10 €
	ATUM 46XD4 WCM. 080412	46	40	54	286	184	216	70	WCM. 080412	116,80 €
	ATUM 47XD4 WCM. 080412	47	40	54	290	188	220	70	WCM. 080412	124,10 €
	ATUM 48XD4 WCM. 080412	48	40	54	294	192	224	70	WCM. 080412	130,80 €
	ATUM 49XD4 WCM. 080412	49	40	54	298	196	228	70	WCM. 080412	137,50 €
ATUM 50XD4 WCM. 080412	50	40	54	302	200	232	70	WCM. 080412	144,60 €	

**ISO
UCUNA UYGUNDUR.**

TAKMA UÇLU MATKAPLAR (SPMG) U-DRILL SİSTEM

D2

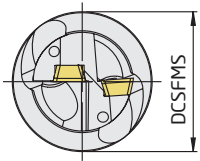
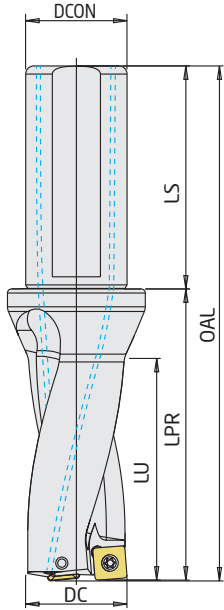

TGTC
UCUNA UYGUNDUR.

TAKIM KODU	TAKIM ÖLÇÜLERİ (mm)							KESİCİ UÇ	FİYAT
	DC	DCON	DCSFMS	OAL	LU	LPR	LS		
ATUM 12.5XD2 SP.. 050204	12.5	20	25	96	24	46	50	SP.. 050204	65,10 €
ATUM 13XD2 SP.. 050204	13	20	25	98	26	48	50	SP.. 050204	65,10 €
ATUM 13.5XD2 SP.. 050204	13.5	20	25	98	26	48	50	SP.. 050204	65,10 €
ATUM 14XD2 SP.. 050204	14	20	25	100	28	50	50	SP.. 050204	65,10 €
ATUM 14.5XD2 SP.. 050204	14.5	20	25	100	28	50	50	SP.. 050204	65,10 €
ATUM 15XD2 SP.. 050204	15	20	25	102	30	52	50	SP.. 050204	65,10 €
ATUM 15.5XD2 SP.. 060204	15.5	20	25	102	30	52	50	SP.. 060204	65,10 €
ATUM 16XD2 SP.. 060204	16	25	34	110	32	54	56	SP.. 060204	65,10 €
ATUM 16.5XD2 SP.. 060204	16.5	25	34	110	32	54	56	SP.. 060204	65,10 €
ATUM 17XD2 SP.. 060204	17	25	34	112	34	56	56	SP.. 060204	65,10 €
ATUM 17.5XD2 SP.. 060204	17.5	25	34	112	34	56	56	SP.. 060204	65,10 €
ATUM 18XD2 SP.. 060204	18	25	34	114	36	58	56	SP.. 060204	65,10 €
ATUM 18.5D2 SP.. 060204	18.5	25	34	114	36	58	56	SP.. 060204	65,10 €
ATUM 19XD2 SP.. 060204	19	25	34	116	38	60	56	SP.. 060204	65,10 €
ATUM 19.5XD2 SP.. 060204	19.5	25	34	116	38	60	56	SP.. 060204	65,10 €
ATUM 20XD2 SP.. 060204	20	25	34	118	40	62	56	SP.. 060204	69,60 €
ATUM 20.5XD2 SP.. 060204	20.5	25	34	118	40	62	56	SP.. 060204	69,60 €
ATUM 21XD2 SP.. 060204	21	25	34	120	42	64	56	SP.. 060204	69,60 €
ATUM 21.5XD2 SP.. 060204	21.5	25	34	120	42	64	56	SP.. 060204	69,60 €
ATUM 22XD2 SP.. 07T308	22	25	34	122	44	66	56	SP.. 07T308	69,60 €
ATUM 22.5XD2 SP.. 07T308	22.5	25	34	122	44	66	56	SP.. 07T308	69,60 €
ATUM 23XD2 SP.. 07T308	23	25	34	124	46	68	56	SP.. 07T308	69,60 €
ATUM 23.5XD2 SP.. 07T308	23.5	25	34	124	46	68	56	SP.. 07T308	69,60 €
ATUM 24XD2 SP.. 07T308	24	25	34	126	48	70	56	SP.. 07T308	71,30 €
ATUM 24.5XD2 SP.. 07T308	24.5	25	34	126	48	70	56	SP.. 07T308	71,30 €
ATUM 25XD2 SP.. 07T308	25	25	34	128	50	72	56	SP.. 07T308	71,30 €
ATUM 25.5XD2 SP.. 07T308	25.5	25	34	128	50	72	56	SP.. 07T308	71,30 €
ATUM 26XD2 SP.. 07T308	26	25	34	130	52	74	56	SP.. 07T308	71,30 €
ATUM 26.5XD2 SP.. 07T308	26.5	25	34	130	52	74	56	SP.. 07T308	71,30 €
ATUM 27XD2 SP.. 07T308	27	25	34	132	54	76	56	SP.. 07T308	71,30 €
ATUM 27.5XD2 SP.. 07T308	27.5	25	34	132	54	76	56	SP.. 07T308	71,30 €
ATUM 28XD2 SP.. 090408	28	25	34	134	56	78	56	SP.. 090408	71,30 €
ATUM 28.5XD2 SP.. 090408	28.5	25	34	134	56	78	56	SP.. 090408	71,30 €
ATUM 29XD2 SP.. 090408	29	25	34	136	58	80	56	SP.. 090408	71,30 €
ATUM 29.5XD2 SP.. 090408	29.5	25	34	136	58	80	56	SP.. 090408	71,30 €
ATUM 30XD2 SP.. 090408	30	32	44	147	60	87	60	SP.. 090408	75,90 €
ATUM 31XD2 SP.. 090408	31	32	44	149	62	89	60	SP.. 090408	75,90 €
ATUM 32XD2 SP.. 090408	32	32	44	151	64	91	60	SP.. 090408	75,90 €
ATUM 33XD2 SP.. 090408	33	32	44	153	66	93	60	SP.. 090408	75,90 €
ATUM 34XD2 SP.. 110408	34	32	44	155	68	95	60	SP.. 110408	75,90 €
ATUM 35XD2 SP.. 110408	35	32	44	157	70	97	60	SP.. 110408	75,90 €
ATUM 36XD2 SP.. 110408	36	32	44	159	72	99	60	SP.. 110408	75,90 €
ATUM 37XD2 SP.. 110408	37	32	44	161	74	101	60	SP.. 110408	75,90 €
ATUM 38XD2 SP.. 110408	38	32	44	163	76	103	60	SP.. 110408	75,90 €
ATUM 39XD2 SP.. 110408	39	32	44	165	78	105	60	SP.. 110408	75,90 €
ATUM 40XD2 SP.. 110408	40	32	44	167	80	107	60	SP.. 110408	75,90 €
ATUM 41XD2 SP.. 110408	41	32	44	169	82	109	60	SP.. 110408	78,00 €
ATUM 42XD2 SP.. 140512	42	32	44	171	84	111	60	SP.. 140512	78,00 €
ATUM 43XD2 SP.. 140512	43	32	44	173	86	113	60	SP.. 140512	78,00 €
ATUM 44XD2 SP.. 140512	44	32	44	175	88	115	60	SP.. 140512	78,00 €
ATUM 45XD2 SP.. 140512	45	40	54	192	90	122	70	SP.. 140512	85,10 €
ATUM 46XD2 SP.. 140512	46	40	54	194	92	124	70	SP.. 140512	89,00 €
ATUM 47XD2 SP.. 140512	47	40	54	196	94	126	70	SP.. 140512	95,30 €
ATUM 48XD2 SP.. 140512	48	40	54	198	96	128	70	SP.. 140512	99,80 €
ATUM 49XD2 SP.. 140512	49	40	54	200	98	130	70	SP.. 140512	104,30 €
ATUM 50XD2 SP.. 140512	50	40	54	202	100	132	70	SP.. 140512	108,60 €

TAKMA UÇLU MATKAPLAR (SPMG) U-DRILL SİSTEMİ

D3	TAKIM KODU	TAKIM ÖLÇÜLERİ (mm)							KESİCİ UÇ	FİYAT
		DC	DCON	DCSFS	OAL	LU	LPR	LS		
	ATUM 12.5XD3 SP.. 050204	12,5	20	25	108	36	58	50	SP.. 050204	71,30 €
	ATUM 13XD3 SP.. 050204	13	20	25	111	39	61	50	SP.. 050204	71,30 €
	ATUM 13.5XD3 SP.. 050204	13,5	20	25	111	39	61	50	SP.. 050204	71,30 €
	ATUM 14XD3 SP.. 050204	14	20	25	114	42	64	50	SP.. 050204	71,30 €
	ATUM 14.5XD3 SP.. 050204	14,5	20	25	114	42	64	50	SP.. 050204	71,30 €
	ATUM 15XD3 SP.. 050204	15	20	25	117	45	67	50	SP.. 050204	71,30 €
	ATUM 15.5XD3 SP.. 060204	15,5	20	25	117	45	67	50	SP.. 060204	71,30 €
	ATUM 16XD3 SP.. 060204	16	25	34	126	48	70	56	SP.. 060204	71,30 €
	ATUM 16.5XD3 SP.. 060204	16,5	25	34	126	48	70	56	SP.. 060204	71,30 €
	ATUM 17XD3 SP.. 060204	17	25	34	129	51	73	56	SP.. 060204	71,30 €
	ATUM 17.5XD3 SP.. 060204	17,5	25	34	129	51	73	56	SP.. 060204	71,30 €
	ATUM 18XD3 SP.. 060204	18	25	34	132	54	76	56	SP.. 060204	71,30 €
	ATUM 18.5XD3 SP.. 060204	18,5	25	34	132	54	76	56	SP.. 060204	71,30 €
	ATUM 19xD3 SP.. 060204	19	25	34	135	57	79	56	SP.. 060204	71,30 €
	ATUM 19.5XD3 SP.. 060204	19,5	25	34	135	57	79	56	SP.. 060204	71,30 €
	ATUM 20XD3 SP.. 060204	20	25	34	138	60	82	56	SP.. 060204	74,10 €
	ATUM 20.5XD3 SP.. 060204	20,5	25	34	138	60	82	56	SP.. 060204	74,10 €
	ATUM 21XD3 SP.. 060204	21	25	34	141	63	85	56	SP.. 060204	74,10 €
	ATUM 21.5XD3 SP.. 060204	21,5	25	34	141	63	85	56	SP.. 060204	74,10 €
	ATUM 22XD3 SP.. 07T308	22	25	34	144	66	88	56	SP.. 07T308	74,10 €
	ATUM 22.5XD3 SP.. 07T308	22,5	25	34	144	66	88	56	SP.. 07T308	74,10 €
	ATUM 23XD3 SP.. 07T308	23	25	34	147	69	91	56	SP.. 07T308	74,10 €
	ATUM 23.5XD3 SP.. 07T308	23,5	25	34	147	69	91	56	SP.. 07T308	74,10 €
	ATUM 24XD3 SP.. 07T308	24	25	34	150	72	94	56	SP.. 07T308	75,90 €
	ATUM 24.5XD3 SP.. 07T308	24,5	25	34	150	72	94	56	SP.. 07T308	75,90 €
	ATUM 25XD3 SP.. 07T308	25	25	34	153	75	97	56	SP.. 07T308	75,90 €
	ATUM 25.5XD3 SP.. 07T308	25,5	25	34	153	75	97	56	SP.. 07T308	75,90 €
	ATUM 26XD3 SP.. 07T308	26	25	34	156	78	100	56	SP.. 07T308	75,90 €
	ATUM 26.5XD3 SP.. 07T308	26,5	25	34	156	78	100	56	SP.. 07T308	75,90 €
	ATUM 27XD3 SP.. 07T308	27	25	34	159	81	103	56	SP.. 07T308	75,90 €
	ATUM 27.5XD3 SP.. 07T308	27,5	25	34	159	81	103	56	SP.. 07T308	75,90 €
	ATUM 28XD3 SP.. 090408	28	25	34	162	84	106	56	SP.. 090408	75,90 €
	ATUM 28.5XD3 SP.. 090408	28,5	25	34	162	84	106	56	SP.. 090408	75,90 €
	ATUM 29XD3 SP.. 090408	29	25	34	165	87	109	56	SP.. 090408	75,90 €
	ATUM 29.5XD3 SP.. 090408	29,5	25	34	165	87	109	56	SP.. 090408	75,90 €
	ATUM 30XD3 SP.. 090408	30	32	44	177	90	117	60	SP.. 090408	78,00 €
	ATUM 30.5XD3 SP.. 090408	30,5	32	44	177	90	117	60	SP.. 090408	78,00 €
	ATUM 31XD3 SP.. 090408	31	32	44	180	93	120	60	SP.. 090408	78,00 €
	ATUM 31.5XD3 SP.. 090408	31,5	32	44	180	93	120	60	SP.. 090408	78,00 €
	ATUM 32XD3 SP.. 090408	32	32	44	183	96	123	60	SP.. 090408	78,00 €
	ATUM 32.5XD3 SP.. 090408	32,5	32	44	183	96	123	60	SP.. 090408	78,00 €
	ATUM 33XD3 SP.. 090408	33	32	44	186	99	126	60	SP.. 090408	78,00 €
	ATUM 33.5XD3 SP.. 090408	33,5	32	44	186	99	126	60	SP.. 090408	78,00 €
	ATUM 34XD3 SP.. 110408	34	32	44	189	102	129	60	SP.. 110408	78,00 €
	ATUM 34.5XD3 SP.. 110408	34,5	32	44	189	102	129	60	SP.. 110408	78,00 €
	ATUM 35XD3 SP.. 110408	35	32	44	192	105	132	60	SP.. 110408	78,00 €
	ATUM 35.5XD3 SP.. 110408	35,5	32	44	192	105	132	60	SP.. 110408	78,00 €
	ATUM 36XD3 SP.. 110408	36	32	44	195	108	135	60	SP.. 110408	78,00 €
	ATUM 36.5XD3 SP.. 110408	36,5	32	44	195	108	135	60	SP.. 110408	78,00 €
	ATUM 37XD3 SP.. 110408	37	32	44	198	111	138	60	SP.. 110408	78,00 €
	ATUM 37.5XD3 SP.. 110408	37,5	32	44	198	111	138	60	SP.. 110408	78,00 €
	ATUM 38XD3 SP.. 110408	38	32	44	201	114	141	60	SP.. 110408	78,00 €
	ATUM 38.5XD3 SP.. 110408	38,5	32	44	201	114	141	60	SP.. 110408	78,00 €
	ATUM 39XD3 SP.. 110408	39	32	44	204	117	144	60	SP.. 110408	78,00 €
	ATUM 39.5XD3 SP.. 110408	39,5	32	44	204	117	144	60	SP.. 110408	78,00 €
	ATUM 40XD3 SP.. 110408	40	32	44	207	120	147	60	SP.. 110408	78,00 €
	ATUM 40.5XD3 SP.. 110408	40,5	32	44	207	120	147	60	SP.. 110408	78,00 €
	ATUM 41XD3 SP.. 110408	41	32	44	210	123	150	60	SP.. 110408	86,60 €
	ATUM 41.5XD3 SP.. 110408	41,5	32	44	210	123	150	60	SP.. 110408	86,60 €
	ATUM 42XD3 SP.. 140512	42	32	44	213	126	153	60	SP.. 140512	86,60 €
	ATUM 42.5XD3 SP.. 140512	42,5	32	44	213	126	153	60	SP.. 140512	86,60 €

**TGTC
UCUNA UYGUNDUR.**

TAKMA UÇLU MATKAPLAR (SPMG) U-DRILL SİSTEM

70/71

	TAKIM KODU	TAKIM ÖLÇÜLERİ (mm)							KESİCİ UÇ	FİYAT
		DC	DCON	DCSFS	OAL	LU	LPR	LS		
 <p>D3</p> <p>TGTC UCUNA UYGUNDUR.</p>	ATUM 43XD3 SP.. 140512	43	32	44	216	129	156	60	SP.. 140512	86,60 €
	ATUM 43.5XD3 SP.. 140512	43.5	32	44	216	129	156	60	SP.. 140512	86,60 €
	ATUM 44XD3 SP.. 140512	44	32	44	219	132	159	60	SP.. 140512	86,60 €
	ATUM 44.5XD3 SP.. 140512	44.5	32	44	219	132	159	60	SP.. 140512	86,60 €
	ATUM 45XD3 SP.. 140512	45	40	54	237	135	167	70	SP.. 140512	91,40 €
	ATUM 45.5XD3 SP.. 140512	45.5	40	54	237	135	167	70	SP.. 140512	91,40 €
	ATUM 46XD3 SP.. 140512	46	40	54	240	138	170	70	SP.. 140512	95,30 €
	ATUM 47XD3 SP.. 140512	47	40	54	243	141	173	70	SP.. 140512	99,80 €
	ATUM 48XD3 SP.. 140512	48	40	54	246	144	176	70	SP.. 140512	104,30 €
	ATUM 49XD3 SP.. 140512	49	40	54	249	147	179	70	SP.. 140512	108,60 €
	ATUM 50XD3 SP.. 140512	50	40	54	252	150	182	70	SP.. 140512	116,80 €
	ATUM 51XD3 SP.. 140512	51	40	54	255	153	185	70	SP.. 140512	121,30 €
	ATUM 52XD3 SP.. 140512	52	40	54	258	156	188	70	SP.. 140512	126,30 €

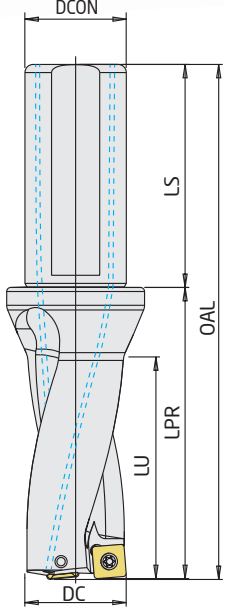
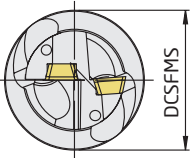
	TAKIM KODU	TAKIM ÖLÇÜLERİ (mm)							KESİCİ UÇ	FİYAT
		DC	DCON	DCSFS	OAL	LU	LPR	LS		
   <p>D4</p> <p>TGTC UCUNA UYGUNDUR.</p>	ATUM 13XD4 SP.. 050204	13	20	25	124	52	74	50	SP.. 050204	86,20 €
	ATUM 14XD4 SP.. 050204	14	20	25	128	56	78	50	SP.. 050204	86,20 €
	ATUM 15XD4 SP.. 050204	15	20	25	132	60	82	50	SP.. 050204	86,20 €
	ATUM 16XD4 SP.. 060204	16	25	34	142	64	86	56	SP.. 060204	86,20 €
	ATUM 17XD4 SP.. 060204	17	25	34	146	68	90	56	SP.. 060204	86,20 €
	ATUM 17.5XD4 SP.. 060204	17.5	25	34	146	68	90	56	SP.. 060204	86,20 €
	ATUM 18XD4 SP.. 060204	18	25	34	150	72	94	56	SP.. 060204	86,20 €
	ATUM 19XD4 SP.. 060204	19	25	34	154	76	98	56	SP.. 060204	86,20 €
	ATUM 19.5XD4 SP.. 060204	19.5	25	34	154	76	98	56	SP.. 060204	86,20 €
	ATUM 20XD4 SP.. 060204	20	25	34	158	80	102	56	SP.. 060204	89,70 €
	ATUM 21XD4 SP.. 060204	21	25	34	162	84	106	56	SP.. 060204	89,70 €
	ATUM 22XD4 SP.. 07T308	22	25	34	166	88	110	56	SP.. 07T308	89,70 €
	ATUM 23XD4 SP.. 07T308	23	25	34	170	92	114	56	SP.. 07T308	89,70 €
	ATUM 23.5XD4 SP.. 07T308	23.5	25	34	170	92	114	56	SP.. 07T308	89,70 €
	ATUM 24XD4 SP.. 07T308	24	25	34	174	96	118	56	SP.. 07T308	93,10 €
	ATUM 25XD4 SP.. 07T308	25	25	34	178	100	122	56	SP.. 07T308	93,10 €
	ATUM 26XD4 SP.. 07T308	26	25	34	182	104	126	56	SP.. 07T308	93,10 €
	ATUM 27XD4 SP.. 07T308	27	25	34	186	108	130	56	SP.. 07T308	93,10 €
	ATUM 27.5XD4 SP.. 07T308	27.5	25	34	186	108	130	56	SP.. 07T308	93,10 €
	ATUM 28XD4 SP.. 090408	28	25	34	190	112	134	56	SP.. 090408	93,10 €
	ATUM 29XD4 SP.. 090408	29	25	34	194	116	138	56	SP.. 090408	93,10 €
	ATUM 30XD4 SP.. 090408	30	32	44	207	120	147	60	SP.. 090408	96,60 €
	ATUM 31XD4 SP.. 090408	31	32	44	211	124	151	60	SP.. 090408	96,60 €
	ATUM 32XD4 SP.. 090408	32	32	44	215	128	155	60	SP.. 090408	96,60 €
	ATUM 33XD4 SP.. 090408	33	32	44	219	132	159	60	SP.. 090408	96,60 €
	ATUM 33.5XD4 SP.. 090408	33.5	32	44	219	132	159	60	SP.. 090408	96,60 €
	ATUM 34XD4 SP.. 110408	34	32	44	223	136	163	60	SP.. 110408	96,60 €
	ATUM 35XD4 SP.. 110408	35	32	44	227	140	167	60	SP.. 110408	96,60 €
	ATUM 36XD4 SP.. 110408	36	32	44	231	144	171	60	SP.. 110408	96,60 €
	ATUM 37XD4 SP.. 110408	37	32	44	235	148	175	60	SP.. 110408	96,60 €
	ATUM 38XD4 SP.. 110408	38	32	44	239	152	179	60	SP.. 110408	96,60 €
	ATUM 39XD4 SP.. 110408	39	32	44	243	156	183	60	SP.. 110408	96,60 €
	ATUM 40XD4 SP.. 110408	40	32	44	247	160	187	60	SP.. 110408	96,60 €
	ATUM 41XD4 SP.. 110408	41	32	44	251	164	191	60	SP.. 110408	103,20 €
ATUM 42XD4 SP.. 140512	42	32	44	255	168	195	60	SP.. 140512	103,20 €	
ATUM 43XD4 SP.. 140512	43	32	44	259	172	199	60	SP.. 140512	103,20 €	
ATUM 44XD4 SP.. 140512	44	32	44	263	176	203	60	SP.. 140512	103,20 €	

TAKMA UÇLU MATKAPLAR (SPMG) U-DRILL SİSTEM

	TAKIM KODU	TAKIM ÖLÇÜLERİ (mm)						KESİCİ UÇ	FİYAT	
		DC	DCON	DCSFM5	OAL	LU	LPR			LS
 <p>YENİ</p> <p>D5</p> <p>TGTC UCUNA UYGUNDUR.</p>	ATUM 14XD5 SP.. 050204	14	20	25	142	70	92	50	SP.. 050204	124,80 €
	ATUM 16XD5 SP.. 060204	16	25	34	158	80	102	56	SP.. 060204	124,80 €
	ATUM 17XD5 SP.. 060204	17	25	34	163	85	107	56	SP.. 060204	124,80 €
	ATUM 18XD5 SP.. 060204	18	25	34	168	90	112	56	SP.. 060204	124,80 €
	ATUM 19XD5 SP.. 060204	19	25	34	173	95	117	56	SP.. 060204	124,80 €
	ATUM 20XD5 SP.. 060204	20	25	34	178	100	122	56	SP.. 060204	129,70 €
	ATUM 21XD5 SP.. 060204	21	25	34	183	105	127	56	SP.. 060204	129,70 €
	ATUM 22XD5 SP.. 07T308	22	25	34	188	110	132	56	SP.. 07T308	129,70 €
	ATUM 22XD5 SP.. 07T308-32	22	32	44	197	110	137	60	SP.. 07T308	142,70 €
	ATUM 23XD5 SP.. 07T308	23	25	34	193	115	137	56	SP.. 07T308	129,70 €
	ATUM 23XD5 SP.. 07T308-32	23	32	44	202	115	142	60	SP.. 07T308	142,70 €
	ATUM 24XD5 SP.. 07T308-32	24	32	44	207	120	147	60	SP.. 07T308	146,10 €
	ATUM 25XD5 SP.. 07T308	25	25	34	203	125	147	56	SP.. 07T308	132,80 €
	ATUM 25XD5 SP.. 07T308-32	25	32	44	212	125	152	60	SP.. 07T308	146,10 €
	ATUM 26XD5 SP.. 07T308	26	25	34	208	130	152	56	SP.. 07T308	132,80 €
	ATUM 26XD5 SP.. 07T308-32	26	32	44	217	130	157	60	SP.. 07T308	146,10 €
	ATUM 27XD5 SP.. 07T308	27	25	34	213	135	157	56	SP.. 07T308	132,80 €
	ATUM 27XD5 SP.. 07T308-32	27	32	44	222	135	162	60	SP.. 07T308	146,10 €
	ATUM 28XD5 SP.. 090408-32	28	32	44	227	140	167	60	SP.. 090408	146,10 €
	ATUM 29XD5 SP.. 090408-32	29	32	44	232	145	172	60	SP.. 090408	146,10 €
ATUM 30XD5 SP.. 090408	30	32	44	237	150	177	60	SP.. 090408	136,50 €	
ATUM 31XD5 SP.. 090408	31	32	44	242	155	182	60	SP.. 090408	136,50 €	
ATUM 32XD5 SP.. 090408	32	32	44	247	160	187	60	SP.. 090408	136,50 €	
ATUM 33XD5 SP.. 090408	33	32	44	252	165	192	60	SP.. 090408	136,50 €	

TAKMA UÇLU MATKAPLAR (SPGT) U-DRILL SİSTEM

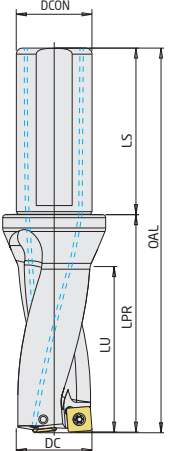
	TAKIM KODU	TAKIM ÖLÇÜLERİ (mm)						KESİCİ UÇ	FİYAT	
		DC	DCON	DCSFM5	OAL	LU	LPR			LS
 <p>D2</p>  <p>ZCC UCUNA UYGUNDUR.</p>	ATUM 12.5XD2 SPGT 050204	12.5	20	25	96	24	46	50	SPGT 050204	65,10 €
	ATUM 13XD2 SPGT 050204	13	20	25	98	26	48	50	SPGT 050204	65,10 €
	ATUM 13.5XD2 SPGT 050204	13.5	20	25	98	26	48	50	SPGT 050204	65,10 €
	ATUM 14XD2 SPGT 050204	14	20	25	100	28	50	50	SPGT 050204	65,10 €
	ATUM 15XD2 SPGT 050204	15	20	25	102	30	52	50	SPGT 050204	65,10 €
	ATUM 16XD2 SPGT 060204	16	25	34	110	32	54	56	SPGT 060204	65,10 €
	ATUM 16.5XD2 SPGT 060204	16.5	25	34	110	32	54	56	SPGT 060204	65,10 €
	ATUM 17XD2 SPGT 060204	17	25	34	112	34	56	56	SPGT 060204	65,10 €
	ATUM 17.5XD2 SPGT 060204	17.5	25	34	112	34	56	56	SPGT 060204	65,10 €
	ATUM 18XD2 SPGT 060204	18	25	34	114	36	58	56	SPGT 060204	65,10 €
	ATUM 19XD2 SPGT 060204	19	25	34	116	38	60	56	SPGT 060204	65,10 €
	ATUM 20XD2 SPGT 060204	20	25	34	118	40	62	56	SPGT 060204	69,60 €
	ATUM 22XD2 SPGT 07T308	22	25	34	122	44	66	56	SPGT 07T308	69,60 €
	ATUM 22.5XD2 SPGT 07T308	22.5	25	34	122	44	66	56	SPGT 07T308	69,60 €
	ATUM 23XD2 SPGT 07T308	23	25	34	124	46	68	56	SPGT 07T308	69,60 €
	ATUM 24XD2 SPGT 07T308	24	25	34	126	48	70	56	SPGT 07T308	71,30 €
	ATUM 25XD2 SPGT 07T308	25	25	34	128	50	72	56	SPGT 07T308	71,30 €
	ATUM 26XD2 SPGT 07T308	26	25	34	130	52	74	56	SPGT 07T308	71,30 €
	ATUM 28XD2 SPGT 090408	28	25	34	134	56	78	56	SPGT 090408	71,30 €
	ATUM 29XD2 SPGT 090408	29	25	34	136	58	80	56	SPGT 090408	71,30 €
ATUM 30XD2 SPGT 090408	30	32	44	147	60	87	60	SPGT 090408	75,90 €	
ATUM 32XD2 SPGT 090408	32	32	44	151	64	91	60	SPGT 090408	75,90 €	
ATUM 35XD2 SPGT 110408	35	32	44	157	70	97	60	SPGT 110408	75,90 €	
ATUM 36XD2 SPGT 110408	36	32	44	159	72	99	60	SPGT 110408	75,90 €	
ATUM 40XD2 SPGT 110408	40	32	44	167	80	107	60	SPGT 110408	75,90 €	

TAKMA UÇLU MATKAPLAR (SPGT) U-DRILL SİSTEM

D4	TAKIM KODU	TAKIM ÖLÇÜLERİ (mm)							KESİCİ UÇ	FİYAT
		DC	DCON	DCSFMS	OAL	LU	LPR	LS		
	ATUM 13XD4 SPGT 050204	13	20	25	124	52	74	50	SPGT 050204	86,20 €
	ATUM 14XD4 SPGT 050204	14	20	25	128	56	78	50	SPGT 050204	86,20 €
	ATUM 15XD4 SPGT 050204	15	20	25	132	60	82	50	SPGT 050204	86,20 €
	ATUM 16XD4 SPGT 060204	16	25	34	142	64	86	56	SPGT 060204	86,20 €
	ATUM 17XD4 SPGT 060204	17	25	34	146	68	90	56	SPGT 060204	86,20 €
	ATUM 17.5XD4 SPGT 060204	17.5	25	34	146	68	90	56	SPGT 060204	86,20 €
	ATUM 18XD4 SPGT 060204	18	25	34	150	72	94	56	SPGT 060204	86,20 €
	ATUM 19XD4 SPGT 060204	19	25	34	154	76	98	56	SPGT 060204	86,20 €
	ATUM 19.5XD4 SPGT 060204	19.5	25	34	154	76	98	56	SPGT 060204	86,20 €
	ATUM 20XD4 SPGT 060204	20	25	34	158	80	102	56	SPGT 060204	89,70 €
	ATUM 21XD4 SPGT 060204	21	25	34	162	84	106	56	SPGT 060204	89,70 €
	ATUM 22XD4 SPGT 07T308	22	25	34	166	88	110	56	SPGT 07T308	89,70 €
	ATUM 23XD4 SPGT 07T308	23	25	34	170	92	114	56	SPGT 07T308	89,70 €
	ATUM 23.5XD4 SPGT 07T308	23.5	25	34	170	92	114	56	SPGT 07T308	89,70 €
	ATUM 24XD4 SPGT 07T308	24	25	34	174	96	118	56	SPGT 07T308	93,10 €
	ATUM 25XD4 SPGT 07T308	25	25	34	178	100	122	56	SPGT 07T308	93,10 €
	ATUM 26XD4 SPGT 07T308	26	25	34	182	104	126	56	SPGT 07T308	93,10 €
	ATUM 27.5XD4 SPGT 07T308	27.5	25	34	186	108	130	56	SPGT 07T308	93,10 €
	ATUM 28XD4 SPGT 090408	28	25	34	190	112	134	56	SPGT 090408	93,10 €
	ATUM 29XD4 SPGT 090408	29	25	34	194	116	138	56	SPGT 090408	93,10 €
	ATUM 30XD4 SPGT 090408	30	32	44	207	120	147	60	SPGT 090408	96,60 €
	ATUM 33.5XD4 SPGT 090408	33.5	32	44	219	132	159	60	SPGT 090408	96,60 €
	ATUM 38XD4 SPGT 110408	38	32	44	239	152	179	60	SPGT 110408	96,60 €

ZCC
UCUNA UYGUNDUR.

TAKMA UÇLU MATKAPLAR (SOMX - SOMT) U-DRILL SİSTEM

D3	TAKIM KODU	TAKIM ÖLÇÜLERİ (mm)							KESİCİ UÇ	FİYAT
		DC	DCON	DCSFMS	OAL	LU	LPR	LS		
	ATUM 14XD3 SO.. 050204	14	20	25	114	42	64	50	SO.. 050204	71,30 €
	ATUM 15XD3 SO.. 050204	15	20	25	117	45	67	50	SO.. 050204	71,30 €
	ATUM 16XD3 SO.. 050204	16	25	34	126	48	70	56	SO.. 050204	71,30 €
	ATUM 16.5XD3 SO.. 050204	16.5	25	34	126	48	70	56	SO.. 050204	71,30 €
	ATUM 17XD3 SO.. 050204	17	25	34	129	51	73	56	SO.. 050204	71,30 €
	ATUM 17.5XD3 SO.. 050204	17.5	25	34	129	51	73	56	SO.. 050204	71,30 €
	ATUM 18XD3 SO.. 060304	18	25	34	132	54	76	56	SO.. 060304	71,30 €
	ATUM 19XD3 SO.. 060204	19	25	34	135	57	79	56	SO.. 060204	71,30 €
	ATUM 20XD3 SO.. 060304	20	25	34	138	60	82	56	SO.. 060304	74,10 €
	ATUM 21XD3 SO.. 070305	21	25	34	140	64	84	56	SO.. 070305	74,10 €
	ATUM 22XD3 SO.. 070305	22	25	34	144	66	88	56	SO.. 070305	74,10 €
	ATUM 22.5XD3 SO.. 070305	22.5	25	34	144	66	88	56	SO.. 070305	74,10 €
	ATUM 23XD3 SO.. 070305	23	25	34	147	69	91	56	SO.. 070305	74,10 €
	ATUM 24XD3 SO.. 070305	24	25	34	150	72	94	56	SO.. 070305	75,90 €
	ATUM 25XD3 SO.. 09T306	25	25	34	153	75	97	56	SO.. 09T306	75,90 €
	ATUM 26XD3 SO.. 09T306	26	25	34	156	78	100	56	SO.. 09T306	75,90 €
	ATUM 27XD3 SO.. 09T306	27	25	34	159	81	103	56	SO.. 09T306	75,90 €
	ATUM 29XD3 SO.. 09T306	29	25	34	165	87	109	56	SO.. 09T306	75,90 €
	ATUM 30XD3 SO.. 09T306	30	32	44	177	90	117	60	SO.. 09T306	78,00 €
	ATUM 31XD3 SO.. 09T306	31	32	44	180	93	120	60	SO.. 09T306	78,00 €
	ATUM 33XD3 SO.. 09T306	33	32	44	186	99	126	60	SO.. 09T306	78,00 €
	ATUM 35XD3 SO.. 120408	35	32	44	192	105	132	60	SO.. 120408	78,00 €
	ATUM 36XD3 SO.. 120408	36	32	44	195	108	135	60	SO.. 120408	78,00 €
	ATUM 37XD3 SO.. 120408	37	32	44	198	111	138	60	SO.. 120408	78,00 €
	ATUM 38XD3 SO.. 120408	38	32	44	201	114	141	60	SO.. 120408	78,00 €
	ATUM 39XD3 SO.. 120408	39	32	44	204	117	144	60	SO.. 120408	78,00 €
	ATUM 40XD3 SO.. 120408	40	32	44	207	120	147	60	SO.. 120408	78,00 €
	ATUM 43XD3 SO.. 120408	43	32	44	216	129	156	60	SO.. 120408	86,60 €

ISCR
UCUNA UYGUNDUR.

TAKMA UÇLU MATKAPLAR (SOMX - SOMT) U-DRILL SİSTEM

74/75

	TAKIM KODU	TAKIM ÖLÇÜLERİ (mm)						KESİCİ UÇ	FİYAT	
		DC	DCON	DCSFMS	OAL	LU	LPR			LS
D4 	ATUM 14XD4 SO.. 050204	14	20	25	128	56	78	50	SO.. 050204	86,20 €
	ATUM 14.5XD4 SO.. 050204	14.5	20	25	128	56	78	50	SO.. 050204	86,20 €
	ATUM 15XD4 SO.. 050204	15	20	25	132	60	82	50	SO.. 050204	86,20 €
	ATUM 15.5XD4 SO.. 050204	15.5	20	25	132	60	82	50	SO.. 050204	86,20 €
	ATUM 17XD4 SO.. 050204	17	25	34	146	68	90	56	SO.. 050204	86,20 €
	ATUM 19XD4 SO.. 060304	19	25	34	154	76	98	56	SO.. 060304	86,20 €
	ATUM 19.5XD4 SO.. 060304	19.5	25	34	154	76	98	56	SO.. 060304	86,20 €
	ATUM 20XD4 SO.. 060304	20	25	34	158	80	102	56	SO.. 060304	89,70 €
	ATUM 21XD4 SO.. 070305	21	25	34	162	84	106	56	SO.. 070305	89,70 €
	ATUM 22XD4 SO.. 070305	22	25	34	166	88	110	56	SO.. 070305	89,70 €
	ATUM 22.5XD4 SO.. 070305	22.5	25	34	166	88	110	56	SO.. 070305	89,70 €
	ATUM 23XD4 SO.. 070305	23	25	34	170	92	114	56	SO.. 070305	89,70 €
	ATUM 24XD4 SO.. 070305	24	25	34	174	96	118	56	SO.. 070305	93,10 €
	ATUM 25XD4 SO.. 09T306	25	25	34	178	100	122	56	SO.. 09T306	93,10 €
	ATUM 27XD4 SO.. 09T306	27	25	34	186	108	130	56	SO.. 09T306	93,10 €
	ATUM 28XD4 SO.. 09T306	28	25	34	190	112	134	56	SO.. 09T306	93,10 €
	ATUM 29XD4 SO.. 09T306	29	25	34	194	116	138	56	SO.. 09T306	93,10 €
	ATUM 30XD4 SO.. 09T306	30	32	44	207	120	147	60	SO.. 09T306	96,60 €
	ATUM 31XD4 SO.. 09T306	31	32	44	211	124	151	60	SO.. 09T306	96,60 €
	ATUM 33XD4 SO.. 09T306	33	32	44	219	132	159	60	SO.. 09T306	96,60 €
ATUM 34XD4 SO.. 09T306	34	32	44	223	136	163	60	SO.. 09T306	96,60 €	
ATUM 35XD4 SO.. 120408	35	32	44	227	140	167	60	SO.. 120408	96,60 €	

ISCR
UCUNA UYGUNDUR.

TAKMA UÇLU MATKAPLAR (SPMT-XOMT) U-DRILL SİSTEM

	TAKIM KODU	TAKIM ÖLÇÜLERİ (mm)						KESİCİ UÇ	FİYAT	
		DC	DCON	DCSFMS	OAL	LU	LPR			LS
D2 	ATUM 14XD2 KDR 0502..	14	20	25	100	28	50	50	SPMT 050204-XOMT 050204	65,10 €
	ATUM 18XD2 KDR 0602..	18	25	34	114	36	58	56	SPMT 060205-XOMT 060204	65,10 €
	ATUM 20XD2 KDR 07T2..	20	25	34	118	40	62	56	SPMT 07T208-XOMT 07T205	69,60 €
	ATUM 22XD2 KDR 07T2..	22	25	34	122	44	66	56	SPMT 07T208-XOMT 07T205	69,60 €
	ATUM 24XD2 KDR 0903..	24	25	34	126	48	70	56	SPMT 090308-XOMT 090305	71,30 €
	ATUM 25XD2 KDR 0903..	25	25	34	128	50	72	56	SPMT 090308-XOMT 090305	71,30 €
	ATUM 26XD2 KDR 0903..	26	25	34	130	52	74	56	SPMT 090308-XOMT 090305	71,30 €
	ATUM 28XD2 KDR 0903..	28	25	34	134	56	78	56	SPMT 090308-XOMT 090305	71,30 €
	ATUM 30XD2 KDR 11T3..	30	25	34	147	60	87	60	SPMT 11T308-XOMT 11T306	75,90 €
	ATUM 32XD2 KDR 11T3..	32	32	44	151	64	91	60	SPMT 11T308-XOMT 11T306	75,90 €
	ATUM 34XD2 KDR 11T3..	34	32	44	155	68	95	60	SPMT 11T308-XOMT 11T306	75,90 €
	ATUM 37XD2 KDR 1304..	37	32	44	161	74	101	60	SPMT 13T410-XOMT 13T406	75,90 €

KRLY
UCUNA UYGUNDUR.

Takma Uçlu Matkap Kullanma Kılavuzu : S 142

Sipariş Örneği: 1 ad. ATUM 14XD4 SO.. 050204

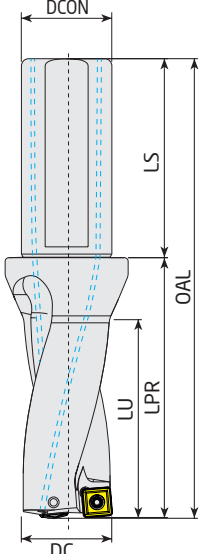
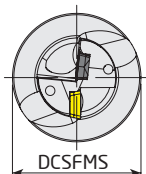

TAKMA UÇLU MATKAPLAR (SPMT-XOMT) U-DRILL SİSTEMİ

D3	TAKIM KODU	TAKIM ÖLÇÜLERİ (mm)							KESİCİ UÇ	FİYAT
		DC	DCON	DCSFMS	OAL	LU	LPR	LS		
   KRLY UCUNA UYGUNDUR.	ATUM 12.5XD3 KDR 0402..	12.5	20	25	108	36	58	50	SPMT 040204-XOMT 040204	71,30 €
	ATUM 13XD3 KDR 0402..	13	20	25	111	39	61	50	SPMT 040204-XOMT 040204	71,30 €
	ATUM 14XD3 KDR 0502..	14	20	25	114	42	64	50	SPMT 050204-XOMT 050204	71,30 €
	ATUM 14.5XD3 KDR 0502..	14.5	20	25	114	42	64	50	SPMT 050204-XOMT 050204	71,30 €
	ATUM 15XD3 KDR 0502..	15	20	25	117	45	67	50	SPMT 050204-XOMT 050204	71,30 €
	ATUM 15.5XD3 KDR 0502..	15.5	20	25	117	45	67	50	SPMT 050204-XOMT 050204	71,30 €
	ATUM 16XD3 KDR 0502..	16	25	34	126	48	70	56	SPMT 050204-XOMT 050204	71,30 €
	ATUM 16.5XD3 KDR 0602..	16.5	25	34	126	48	70	56	SPMT 060205-XOMT 060204	71,30 €
	ATUM 17XD3 KDR 0602..	17	25	34	129	51	73	56	SPMT 060205-XOMT 060204	71,30 €
	ATUM 17.5XD3 KDR 0602..	17.5	25	34	129	51	73	56	SPMT 060205-XOMT 060204	71,30 €
	ATUM 18XD3 KDR 0602..	18	25	34	132	54	76	56	SPMT 060205-XOMT 060204	71,30 €
	ATUM 18.5XD3 KDR 0602..	18.5	25	34	132	54	76	56	SPMT 060205-XOMT 060204	71,30 €
	ATUM 19XD3 KDR 0602..	19	25	34	135	57	79	56	SPMT 060205-XOMT 060204	71,30 €
	ATUM 19.5XD3 KDR 0602..	19.5	25	34	135	57	79	56	SPMT 060205-XOMT 060204	71,30 €
	ATUM 20XD3 KDR 07T2..	20	25	34	138	60	82	56	SPMT 07T208-XOMT 07T205	74,10 €
	ATUM 20.5XD3 KDR 07T2..	20.5	25	34	138	60	82	56	SPMT 07T208-XOMT 07T205	74,10 €
	ATUM 21XD3 KDR 07T2..	21	25	34	141	63	85	56	SPMT 07T208-XOMT 07T205	74,10 €
	ATUM 22XD3 KDR 07T2..	22	25	34	144	66	88	56	SPMT 07T208-XOMT 07T205	74,10 €
	ATUM 23XD3 KDR 07T2..	23	25	34	147	69	91	56	SPMT 07T208-XOMT 07T205	74,10 €
	ATUM 23.5XD3 KDR 07T2..	23.5	25	34	147	69	91	56	SPMT 07T208-XOMT 07T205	74,10 €
	ATUM 24XD3 KDR 0903..	24	25	34	150	72	94	56	SPMT 090308-XOMT 090305	75,90 €
	ATUM 24.5XD3 KDR 0903..	24.5	25	34	150	72	94	56	SPMT 090308-XOMT 090305	75,90 €
	ATUM 25XD3 KDR 0903..	25	25	34	153	75	97	56	SPMT 090308-XOMT 090305	75,90 €
	ATUM 26XD3 KDR 0903..	26	25	34	156	78	100	56	SPMT 090308-XOMT 090305	75,90 €
	ATUM 27XD3 KDR 0903..	27	25	34	159	81	103	56	SPMT 090308-XOMT 090305	75,90 €
	ATUM 28XD3 KDR 0903..	28	25	34	162	84	106	56	SPMT 090308-XOMT 090305	75,90 €
	ATUM 29XD3 KDR 0903..	29	25	34	165	87	109	56	SPMT 090308-XOMT 090305	75,90 €
	ATUM 30XD3 KDR 11T3..	30	32	44	177	90	117	60	SPMT 11T308-XOMT 11T306	78,00 €
	ATUM 32XD3 KDR 11T3..	32	32	44	183	96	123	60	SPMT 11T308-XOMT 11T306	78,00 €
	ATUM 33XD3 KDR 11T3..	33	32	44	186	99	126	60	SPMT 11T308-XOMT 11T306	78,00 €
	ATUM 34XD3 KDR 11T3..	34	32	44	189	102	129	60	SPMT 11T308-XOMT 11T306	78,00 €
	ATUM 35XD3 KDR 11T3..	35	32	44	192	105	132	60	SPMT 11T308-XOMT 11T306	78,00 €
	ATUM 37XD3 KDR 1304..	37	32	44	198	111	138	60	SPMT 130410-XOMT 130406	78,00 €
	ATUM 38XD3 KDR 1304..	38	32	44	201	114	141	60	SPMT 130410-XOMT 130406	78,00 €
	ATUM 39XD3 KDR 1304..	39	32	44	204	117	144	60	SPMT 130410-XOMT 130406	78,00 €
	ATUM 40XD3 KDR 1304..	40	32	44	207	120	147	60	SPMT 130410-XOMT 130406	78,00 €

D4	TAKIM KODU	TAKIM ÖLÇÜLERİ (mm)							KESİCİ UÇ	FİYAT
		DC	DCON	DCSFMS	OAL	LU	LPR	LS		
 KRLY UCUNA UYGUNDUR.	ATUM 14XD4 KDR 0502..	14	20	25	128	56	78	50	SPMT 050204-XOMT 050204	86,20 €
	ATUM 14.5XD4 KDR 0502..	14.5	20	25	128	56	78	50	SPMT 050204-XOMT 050204	86,20 €
	ATUM 15XD4 KDR 0502..	15	20	25	132	60	82	50	SPMT 050204-XOMT 050204	86,20 €
	ATUM 15.5XD4 KDR 0502..	15.5	20	25	132	60	82	50	SPMT 050204-XOMT 050204	86,20 €
	ATUM 16XD4 KDR 0502..	16	25	34	142	64	86	56	SPMT 050204-XOMT 050204	86,20 €
	ATUM 17XD4 KDR 0602..	17	25	34	146	68	90	56	SPMT 060205-XOMT 060204	86,20 €
	ATUM 17.5XD4 KDR 0602..	17.5	25	34	146	68	90	56	SPMT 060205-XOMT 060204	86,20 €
	ATUM 18XD4 KDR 0602..	18	25	34	150	72	94	56	SPMT 060205-XOMT 060204	86,20 €
	ATUM 18.5XD4 KDR 0602..	18.5	25	34	150	72	94	56	SPMT 060205-XOMT 060204	86,20 €
	ATUM 19XD4 KDR 0602..	19	25	34	154	76	98	56	SPMT 060205-XOMT 060204	86,20 €
	ATUM 20XD4 KDR 07T2..	20	25	34	158	80	102	56	SPMT 07T208-XOMT 07T205	89,70 €
	ATUM 21XD4 KDR 07T2..	21	25	34	162	84	106	56	SPMT 07T208-XOMT 07T205	89,70 €
	ATUM 22XD4 KDR 07T2..	22	25	34	166	88	110	56	SPMT 07T208-XOMT 07T205	89,70 €
	ATUM 24XD4 KDR 0903..	24	25	34	174	96	118	56	SPMT 090308-XOMT 090305	93,10 €
	ATUM 25XD4 KDR 0903..	25	25	34	178	100	122	56	SPMT 090308-XOMT 090305	93,10 €

TAKMA UÇLU MATKAPLAR (SOMT) U-DRILL SİSTEMİ

76/77

	TAKIM KODU	TAKIM ÖLÇÜLERİ (mm)							KESİCİ UÇ	FİYAT
		DC	DCD	DFMS	OAL	LU	LPR	LS		
	ATUM 14XD2 SOMT 050204	14	20	25	100	28	50	50	SOMT 050204	65,10 €
	ATUM 16XD2 SOMT 050204	16	25	34	110	32	54	56	SOMT 050204	65,10 €
	ATUM 17XD2 SOMT 060204	17	25	34	112	34	56	56	SOMT 060204	65,10 €
	ATUM 18XD2 SOMT 060204	18	25	34	114	36	58	56	SOMT 060204	65,10 €
	ATUM 20XD2 SOMT 070306	20	25	34	118	40	62	56	SOMT 070306	69,60 €
	ATUM 22XD2 SOMT 070306	22	25	34	122	44	66	56	SOMT 070306	69,60 €
	ATUM 23XD2 SOMT 08T306	23	25	34	124	46	68	56	SOMT 08T306	69,60 €
	ATUM 24XD2 SOMT 08T306	24	25	34	126	48	70	56	SOMT 08T306	71,30 €
	ATUM 25XD2 SOMT 08T306	25	25	34	128	50	72	56	SOMT 08T306	71,30 €
	ATUM 26XD2 SOMT 08T306	26	25	34	130	52	74	56	SOMT 08T306	71,30 €
	ATUM 27XD2 SOMT 09T308	27	25	34	132	54	76	56	SOMT 09T308	71,30 €
	ATUM 28XD2 SOMT 09T308	28	25	34	134	56	78	56	SOMT 09T308	71,30 €
	ATUM 29XD2 SOMT 09T308	29	25	34	136	58	80	56	SOMT 09T308	71,30 €
	ATUM 30XD2 SOMT 09T308	30	32	44	147	60	87	60	SOMT 09T308	75,90 €
	ATUM 32XD2 SOMT 11T308	32	32	44	151	64	91	60	SOMT 11T308	75,90 €
	ATUM 33XD2 SOMT 11T308	33	32	44	153	66	93	60	SOMT 11T308	75,90 €
	ATUM 34XD2 SOMT 11T308	34	32	44	155	68	95	60	SOMT 11T308	75,90 €
	ATUM 35XD2 SOMT 11T308	35	32	44	157	70	97	60	SOMT 11T308	75,90 €
	ATUM 37XD2 SOMT 130408	37	32	44	161	74	101	60	SOMT 130408	75,90 €
	ATUM 38XD2 SOMT 130408	38	32	44	163	76	103	60	SOMT 130408	75,90 €
ATUM 40XD2 SOMT 130408	40	32	44	167	80	107	60	SOMT 130408	75,90 €	
ATUM 45XD2 SOMT 150510	45	40	54	192	90	122	70	SOMT 150510	85,10 €	
ATUM 47XD2 SOMT 150510	47	40	54	196	94	126	70	SOMT 150510	95,30 €	

TGTC
UCUNA UYGUNDUR.

Takma Uçlu Matkap Kullanma Kılavuzu : S 142

Sipariş Örneği: 1 ad. ATUM 14XD2 SOMT 050204



TAKMA UÇLU MATKAPLAR (SOMT) U-DRILL SİSTEM

D3	TAKIM KODU	TAKIM ÖLÇÜLERİ (mm)						KESİCİ UÇ	FİYAT	
		DC	DCON	DCSFMS	OAL	LU	LPR			LS
	ATUM 14XD3 SOMT 050204	14	20	25	114	42	64	50	SOMT 050204	71,30 €
	ATUM 14.5XD3 SOMT 050204	14.5	20	25	114	42	64	50	SOMT 050204	71,30 €
	ATUM 15XD3 SOMT 050204	15	20	25	117	45	67	50	SOMT 050204	71,30 €
	ATUM 15.5XD3 SOMT 050204	15.5	20	25	117	45	67	50	SOMT 050204	71,30 €
	ATUM 16XD3 SOMT 050204	16	25	34	126	48	70	56	SOMT 050204	71,30 €
	ATUM 16.5XD3 SOMT 060204	16.5	25	34	126	48	70	56	SOMT 060204	71,30 €
	ATUM 17XD3 SOMT 060204	17	25	34	129	51	73	56	SOMT 060204	71,30 €
	ATUM 17.5XD3 SOMT 060204	17.5	25	34	129	51	73	56	SOMT 060204	71,30 €
	ATUM 18XD3 SOMT 060204	18	25	34	132	54	76	56	SOMT 060204	71,30 €
	ATUM 18.5XD3 SOMT 060204	18.5	25	34	132	54	76	56	SOMT 060204	71,30 €
	ATUM 19XD3 SOMT 060204	19	25	34	135	57	79	56	SOMT 060204	71,30 €
	ATUM 19.5XD3 SOMT 070306	19.5	25	34	135	57	79	56	SOMT 070306	71,30 €
	ATUM 20XD3 SOMT 070306	20	25	34	138	60	82	56	SOMT 070306	74,10 €
	ATUM 20.5XD3 SOMT 070306	20.5	25	34	138	60	82	56	SOMT 070306	74,10 €
	ATUM 21XD3 SOMT 070306	21	25	34	141	63	85	56	SOMT 070306	74,10 €
	ATUM 22XD3 SOMT 070306	22	25	34	144	66	88	56	SOMT 070306	74,10 €
	ATUM 22.5XD3 SOMT 08T306	22.5	25	34	144	66	88	56	SOMT 08T306	74,10 €
	ATUM 23XD3 SOMT 08T306	23	25	34	147	69	91	56	SOMT 08T306	74,10 €
	ATUM 23.5XD3 SOMT 08T306	23.5	25	34	147	69	91	56	SOMT 08T306	74,10 €
	ATUM 24XD3 SOMT 08T306	24	25	34	150	72	94	56	SOMT 08T306	75,90 €
	ATUM 24.5XD3 SOMT 08T306	24.5	25	34	150	72	94	56	SOMT 08T306	75,90 €
	ATUM 25XD3 SOMT 08T306	25	25	34	153	75	97	56	SOMT 08T306	75,90 €
	ATUM 26XD3 SOMT 08T306	26	25	34	156	78	100	56	SOMT 08T306	75,90 €
	ATUM 27XD3 SOMT 09T308	27	25	34	159	81	103	56	SOMT 09T308	75,90 €
	ATUM 27.5XD3 SOMT 09T308	27.5	25	34	159	81	103	56	SOMT 09T308	75,90 €
	ATUM 28XD3 SOMT 09T308	28	25	34	162	84	106	56	SOMT 09T308	75,90 €
	ATUM 29XD3 SOMT 09T308	29	25	34	165	87	109	56	SOMT 09T308	75,90 €
	ATUM 30XD3 SOMT 09T308	30	32	44	177	90	117	60	SOMT 09T308	78,00 €
	ATUM 32XD3 SOMT 11T308	32	32	44	183	96	123	60	SOMT 11T308	78,00 €
	ATUM 33XD3 SOMT 11T308	33	32	44	186	99	126	60	SOMT 11T308	78,00 €
	ATUM 34XD3 SOMT 11T308	34	32	44	189	102	129	60	SOMT 11T308	78,00 €
	ATUM 35XD3 SOMT 11T308	35	32	44	192	105	132	60	SOMT 11T308	78,00 €
	ATUM 36XD3 SOMT 11T308	36	32	44	195	108	135	60	SOMT 11T308	78,00 €
	ATUM 37XD3 SOMT 130408	37	32	44	198	111	138	60	SOMT 130408	78,00 €
	ATUM 38XD3 SOMT 130408	38	32	44	201	114	141	60	SOMT 130408	78,00 €
	ATUM 39XD3 SOMT 130408	39	32	44	204	117	144	60	SOMT 130408	78,00 €
	ATUM 40XD3 SOMT 130408	40	32	44	207	120	147	60	SOMT 130408	78,00 €
	ATUM 45XD3 SOMT 150510	45	40	54	237	135	167	70	SOMT 150510	91,40 €
	ATUM 49XD3 SOMT 150510	49	40	54	249	147	179	70	SOMT 150510	108,60 €
	ATUM 50XD3 SOMT 150510	50	40	54	252	150	182	70	SOMT 150510	116,80 €

TGTC
UCUNA UYGUNDUR.

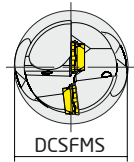
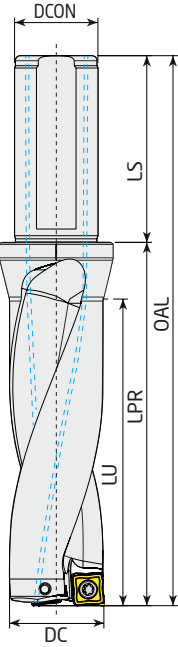

D4	TAKIM KODU	TAKIM ÖLÇÜLERİ (mm)						KESİCİ UÇ	FİYAT	
		DC	DCON	DCSFMS	OAL	LU	LPR			LS
	ATUM 14XD4 SOMT 050204	14	20	25	128	56	78	50	SOMT 050204	86,20 €
	ATUM 14.5XD4 SOMT 050204	14.5	20	25	128	56	78	50	SOMT 050204	86,20 €
	ATUM 16XD4 SOMT 050204	16	25	34	142	64	86	56	SOMT 050204	86,20 €
	ATUM 17XD4 SOMT 060204	17	25	34	146	68	90	56	SOMT 060204	86,20 €
	ATUM 17.5XD4 SOMT 060204	17.5	25	34	146	68	90	56	SOMT 060204	86,20 €
	ATUM 18XD4 SOMT 060204	18	25	34	150	72	94	56	SOMT 060204	86,20 €
	ATUM 19XD4 SOMT 060204	19	25	34	154	76	98	56	SOMT 060204	86,20 €
	ATUM 20XD4 SOMT 070306	20	25	34	158	80	102	56	SOMT 070306	89,70 €
	ATUM 21XD4 SOMT 070306	21	25	34	162	84	106	56	SOMT 070306	89,70 €
	ATUM 22XD4 SOMT 070306	22	25	34	166	88	110	56	SOMT 070306	89,70 €
	ATUM 24XD4 SOMT 08T306	24	25	34	174	96	118	56	SOMT 08T306	93,10 €
	ATUM 25XD4 SOMT 08T306	25	25	34	178	100	122	56	SOMT 08T306	93,10 €

TGTC
UCUNA UYGUNDUR.

TAKMA UÇLU MATKAPLAR (SOMT) U-DRILL SİSTEMİ

78/79

D5	TAKIM KODU	TAKIM ÖLÇÜLERİ (mm)							KESİCİ UÇ	FİYAT
		DC	DCON	DCSFMS	OAL	LU	LPR	LS		
	ATUM 14XD5 SOMT 050204	14	20	25	142	70	92	50	SOMT 050204	124,80 €
	ATUM 15XD5 SOMT 050204	15	20	25	147	75	97	50	SOMT 050204	124,80 €
	ATUM 15.5XD5 SOMT 050204	15.5	20	25	147	75	97	50	SOMT 050204	124,80 €
	ATUM 16XD5 SOMT 050204	16	25	34	158	80	102	56	SOMT 050204	124,80 €
	ATUM 16.5XD5 SOMT 060204	16.5	25	34	158	80	102	56	SOMT 060204	124,80 €
	ATUM 17.5XD5 SOMT 060204	17	25	34	163	85	107	56	SOMT 060204	124,80 €
	ATUM 18XD5 SOMT 060204	18	25	34	168	90	112	56	SOMT 060204	124,80 €
	ATUM 18.5XD5 SOMT 060204	18.5	25	34	168	90	112	56	SOMT 060204	124,80 €
	ATUM 19XD5 SOMT 060204	19	25	34	173	95	117	56	SOMT 060204	124,80 €
	ATUM 19.5XD5 SOMT 070306	19.5	25	34	173	95	117	56	SOMT 070306	124,80 €
	ATUM 20XD5 SOMT 070306	20	25	34	178	100	122	56	SOMT 070306	129,70 €
	ATUM 21XD5 SOMT 070306	21	25	34	183	105	127	56	SOMT 070306	129,70 €
	ATUM 22XD5 SOMT 070306	22	25	34	188	110	132	56	SOMT 070306	129,70 €
	ATUM 23XD5 SOMT 08T306	23	25	34	193	115	137	56	SOMT 08T306	129,70 €
	ATUM 24XD5 SOMT 08T306	24	25	34	198	120	142	56	SOMT 08T306	132,80 €
	ATUM 25XD5 SOMT 08T306	25	25	34	203	125	147	56	SOMT 08T306	132,80 €
	ATUM 26XD5 SOMT 08T306	26	25	34	208	130	152	56	SOMT 08T306	132,80 €
	ATUM 27XD5 SOMT 09T308	27	25	34	213	135	157	56	SOMT 09T308	132,80 €
	ATUM 28XD5 SOMT 09T308	28	25	34	218	140	162	56	SOMT 09T308	132,80 €
	ATUM 29XD5 SOMT 09T308	29	25	34	223	145	167	56	SOMT 09T308	132,80 €
ATUM 30XD5 SOMT 09T308	30	32	44	237	150	177	60	SOMT 09T308	136,50 €	
ATUM 33XD5 SOMT 11T308	33	32	44	252	165	192	60	SOMT 11T308	136,50 €	
ATUM 34XD5 SOMT 11T308	34	32	44	257	170	197	60	SOMT 11T308	136,50 €	
ATUM 35XD5 SOMT 11T308	35	32	44	262	175	202	60	SOMT 11T308	136,50 €	
ATUM 36XD5 SOMT 11T308	36	32	44	267	180	207	60	SOMT 11T308	136,50 €	

TGTC
UCUNA UYGUNDUR.

Takma Uçlu Matkap Kullanma Kılavuzu : S 142

Sipariş Örneği: 1 ad. ATUM 14XD5 SOMT 050204



TAKMA UÇLU MATKAPLAR (880) U-DRILL SİSTEM

	TAKIM KODU	TAKIM ÖLÇÜLERİ (mm)						KESİCİ UÇ	FİYAT	
		DC	DCON	DCSFMS	OAL	LU	LPR			LS
   <p>YENİ</p> <p>D3</p> <p>SNDVK UCUNA UYGUNDUR.</p>	ATUM 14XD3 880-0202..	14	20	25	108	45	58	50	880-02...C / P	78,40 €
	ATUM 14.5XD3 880-0202..	14.5	20	25	110	46	60	50	880-02...C / P	78,40 €
	ATUM 15XD3 880-0202..	15	20	25	112	48	62	50	880-02...C / P	78,40 €
	ATUM 15.5XD3 880-0202..	15.5	20	25	114	50	64	50	880-02...C / P	78,40 €
	ATUM 16XD3 880-0202..	16	20	25	116	51	66	50	880-02...C / P	78,40 €
	ATUM 16.5XD3 880-0303..	16.5	20	25	118	53	68	50	880-03...C / P	78,40 €
	ATUM 17XD3 880-0303..	17	20	25	119	54	69	50	880-03...C / P	78,40 €
	ATUM 17.5XD3 880-0303..	17.5	25	32	128	56	72	56	880-03...C / P	78,40 €
	ATUM 18XD3 880-0303..	18	25	32	129	57	73	56	880-03...C / P	78,40 €
	ATUM 18.5XD3 880-0303..	18.5	25	32	131	59	75	56	880-03...C / P	78,40 €
	ATUM 19XD3 880-0303..	19	25	32	132	60	76	56	880-03...C / P	78,40 €
	ATUM 19.5XD3 880-0303..	19.5	25	32	135	62	79	56	880-03...C / P	78,40 €
	ATUM 20XD3 880-0403..	20	25	32	137	64	81	56	880-04...C / P	81,50 €
	ATUM 20.5XD3 880-0403..	20.5	25	32	138	65	82	56	880-04...C / P	81,50 €
	ATUM 21XD3 880-0403..	21	25	32	140	66	84	56	880-04...C / P	81,50 €
	ATUM 21.5XD3 880-0403..	22	25	32	142	68	86	56	880-04...C / P	81,50 €
	ATUM 22XD3 880-0403..	23	25	32	143	69	87	56	880-04...C / P	81,50 €
	ATUM 22.5XD3 880-0403..	22.5	25	32	146	71	90	56	880-04...C / P	81,50 €
	ATUM 23XD3 880-0403..	23	25	32	147	72	91	56	880-04...C / P	81,50 €
	ATUM 24XD3 880-0503..	24	25	32	151	76	95	56	880-05...C / P	83,50 €
	ATUM 25XD3 880-0503..	25	25	32	155	79	99	56	880-05...C / P	83,50 €
	ATUM 26XD3 880-0503..	26	32	44	162	81	102	60	880-05...C / P	83,50 €
	ATUM 27XD3 880-0503..	27	32	44	165	84	105	60	880-05...C / P	83,50 €
	ATUM 28XD3 880-0503..	28	32	44	169	87	109	60	880-05...C / P	83,50 €
	ATUM 29XD3 880-0503..	29	32	44	172	90	112	60	880-05...C / P	83,50 €
	ATUM 30XD3 880-0604..	30	32	44	177	94	117	60	880-06...C / P	85,80 €
	ATUM 31XD3 880-0604..	31	40	54	191	97	121	70	880-06...C / P	85,80 €
	ATUM 32XD3 880-0604..	32	40	54	194	100	124	70	880-06...C / P	85,80 €
	ATUM 33XD3 880-0604..	33	40	54	198	103	128	70	880-06...C / P	85,80 €
	ATUM 34XD3 880-0604..	34	40	54	201	106	131	70	880-06...C / P	85,80 €
ATUM 35XD3 880-0604..	35	40	54	205	109	135	70	880-06...C / P	85,80 €	
ATUM 36XD3 880-0704..	36	40	54	209	112	139	70	880-07...C / P	85,80 €	
ATUM 38XD3 880-0704..	38	40	54	216	118	146	70	880-07...C / P	85,80 €	
ATUM 39XD3 880-0704..	39	40	54	219	121	149	70	880-07...C / P	85,80 €	
ATUM 40XD3 880-0704..	40	40	54	223	124	153	70	880-07...C / P	85,80 €	
ATUM 41XD3 880-0704..	41	40	54	227	127	157	70	880-07...C / P	95,30 €	
ATUM 42XD3 880-0704..	42	40	54	230	130	160	70	880-07...C / P	95,30 €	
ATUM 45XD3 880-0805..	45	40	54	242	140	172	70	880-08...C / P	100,50 €	
ATUM 46XD3 880-0805..	46	40	54	246	143	176	70	880-08...C / P	104,80 €	
ATUM 48XD3 880-0805..	48	40	54	253	149	183	70	880-08...C / P	114,70 €	
ATUM 50XD3 880-0805..	50	40	54	260	155	190	70	880-08...C / P	128,50 €	

EKSANTRİK U-DRILL ADAPTÖRÜ

	TAKIM KODU	TAKIM ÖLÇÜLERİ (mm)			FİYAT
		DCON	BD	LF	
 <p>Ø+0,4 - Ø-0,2 ARASINDA ONDALIKLI OLARAK AYARLANABİLİR. ÖR: Ø25 TAKIM= 24.80≈25.40 ARASI AYARLANABİLİR.</p>	AET-2025	20	25	44	28,40 €
	AET-2532	25	32	46	28,40 €
	AET-3240	32	40	55	28,40 €

DELİK PAHLAMA BİLEZİĞİ

80/81

	TAKIM KODU	KULLANILACAK ATUM Ø ÖLÇÜSÜ	KESİCİ UÇ	FİYATI
 	ADCR-120-VB1103	12.5	VBM. 1103..	31,30 €
	ADCR-125-VB1103	13	VBM. 1103..	31,30 €
	ADCR-130-VB1103	13.5	VBM. 1103..	31,30 €
	ADCR-135-VB1103	14	VBM. 1103..	31,30 €
	ADCR-140-VB1103	14.5	VBM. 1103..	31,30 €
	ADCR-145-VB1103	15	VBM. 1103..	31,30 €
	ADCR-150-VB1103	15.5-16	VBM. 1103..	31,30 €
	ADCR-155-VB1103	16.5	VBM. 1103..	31,30 €
	ADCR-160-VB1103	17	VBM. 1103..	33,20 €
	ADCR-165-VB1103	17.5	VBM. 1103..	33,20 €
	ADCR-170-VB1103	18	VBM. 1103..	33,20 €
	ADCR-175-VB1103	18.5	VBM. 1103..	33,20 €
	ADCR-180-VB1103	19	VBM. 1103..	33,20 €
	ADCR-185-VB1103	19.5	VBM. 1103..	33,20 €
	ADCR-190-VB1103	20	VBM. 1103..	33,20 €
	ADCR-195-VB1103	20.5	VBM. 1103..	33,20 €
	ADCR-200-VB1103	21	VBM. 1103..	34,50 €
	ADCR-205-VB1103	21.5	VBM. 1103..	34,50 €
	ADCR-210-VB1103	22	VBM. 1103..	34,50 €
	ADCR-215-VB1103	22.5	VBM. 1103..	34,50 €
	ADCR-220-VB1103	23	VBM. 1103..	34,50 €
	ADCR-225-VB1103	23.5	VBM. 1103..	34,50 €
	ADCR-230-VB1103	24	VBM. 1103..	34,50 €
	ADCR-235-VB1103	24.5	VBM. 1103..	34,50 €
	ADCR-240-VB1103	25	VBM. 1103..	34,50 €
	ADCR-245-VB1103	25.5	VBM. 1103..	34,50 €
	ADCR-250-VB1103	26	VBM. 1103..	37,50 €
	ADCR-255-VB1103	26.5	VBM. 1103..	37,50 €
	ADCR-260-VB1103	27	VBM. 1103..	37,50 €
	ADCR-265-VB1103	27.5	VBM. 1103..	37,50 €
	ADCR-270-VB1103	28	VBM. 1103..	37,50 €
	ADCR-275-VB1103	28.5	VBM. 1103..	37,50 €
	ADCR-280-VB1103	29	VBM. 1103..	37,50 €
ADCR-285-VB1103	29.5	VBM. 1103..	37,50 €	
ADCR-290-VB1103	30	VBM. 1103..	37,50 €	
ADCR-295-VB1103	30.5	VBM. 1103..	37,50 €	
ADCR-300-VB1103	31	VBM. 1103..	37,50 €	

EKOKES - DELİK DELME, DELİK İÇİ ve DIŞ ÇAP TORNALAMA

	TAKIM KODU	TAKIM ÖLÇÜLERİ (mm)							KESİCİ UÇ	FİYAT
		DC	DCON	DCSFS	LU	LPR	LS	WF		
 CRTZT-ISCR-TGTC-KRLY UCUNA UYGUNDUR.	AEKL/R-D2.25X8 XC.. 040104	8	10	12	18	22	38	4	XC.. 040104	44,20 €
	AEKL/R-D2.25X10 XC.. 050204	10	12	16	22.5	27.5	42	5	XC.. 050204	44,20 €
	AEKL/R-D2.25X12 XC.. 060204	12	16	20	27	33	45	6	XC.. 060204	45,70 €
	AEKL/R-D2.25X14 XC.. 070304	14	16	20	31.5	38	45	7	XC.. 070304	47,80 €
	AEKL/R-D2.25X16 XC.. 080304	16	20	25	36	44	50	8	XC.. 080304	49,40 €
	AEKL/R-D2.25X18 XC.. 09T304	18	25	32	40.5	50	56	9	XC.. 09T304	55,80 €
	AEKL/R-D2.25X20 XC.. 10T304	20	25	32	45	55	56	10	XC.. 10T304	61,90 €
	AEKL/R-D2.25X25 XC.. 130404	25	32	40	56.5	69	60	12.5	XC.. 130404	69,40 €
	AEKL/R-D2.25X32 XC.. 170504	32	40	50	72	88	70	16	XC.. 170504	71,60 €

AYARLI KABA DELİK İŞLEME BARALARI

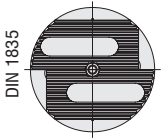
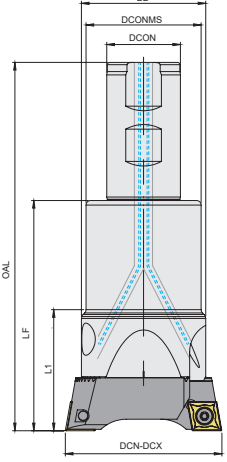
	TAKIM KODU	TAKIM ÖLÇÜLERİ (mm)							KARTUŞ	FİYAT
		DCN-DCX	DCON	DCONMS	BD	OAL	LF	L1		
  	ABHR-D18x22-W16-L90-CC06	18-22	16	-	-	90	42	-	AK.. 18-22	89,70 €
	ABHR-D18x22-W16-L150-CC06	18-22	16	-	-	150	102	-	AK.. 18-22	107,50 €
	ABHR-D18x22-W16-L200-CC06	18-22	16	-	-	200	152	-	AK.. 18-22	134,50 €
	ABHR-D22x28-W20-L100-CC06	22-28	20	-	-	100	50	-	AK.. 22-28	93,10 €
	ABHR-D22x28-W20-L150-CC06	22-28	20	-	-	150	100	-	AK.. 22-28	111,40 €
	ABHR-D22x28-W20-L200-CC06	22-28	20	-	-	200	150	-	AK.. 22-28	139,70 €
	ABHR-D28x38-W20-L110-CC06	28-38	20	25	-	110	60	-	AK.. 28-38	94,60 €
	ABHR-D28x38-W20-L160-CC06	28-38	20	25	-	160	110	-	AK.. 28-38	113,80 €
	ABHR-D28x38-W20-L230-CC06	28-38	20	25	-	230	180	-	AK.. 28-38	142,20 €
	ABHR-D36x50-W25-L120-CC06	36-50	25	32	-	120	64	-	AK.. 36-50	96,60 €
	ABHR-D36x50-W25-L170-CC06	36-50	25	32	-	170	114	-	AK.. 36-50	115,90 €
	ABHR-D36x50-W25-L250-CC06	36-50	25	32	-	250	194	-	AK.. 36-50	144,80 €
	ABHR-D36x50-W25-L120-CC09	36-50	25	32	-	120	64	-	AK.. 36-50-09	96,60 €
	ABHR-D36x50-W25-L170-CC09	36-50	25	32	-	170	114	-	AK.. 36-50-09	115,90 €
	ABHR-D36x50-W25-L250-CC09	36-50	25	32	-	250	194	-	AK.. 36-50-09	144,80 €
	ABHR-D50x68-W32-L140-CC09	50-68	32	40	-	140	80	-	AK.. 50-68	99,80 €
	ABHR-D50x68-W32-L200-CC09	50-68	32	40	-	200	140	-	AK.. 50-68	119,80 €
	ABHR-D50x68-W32-L280-CC09	50-68	32	40	-	280	220	-	AK.. 50-68	150,00 €
	ABHR-D50x68-W32-L140-CC12	50-68	32	40	-	140	80	-	AK.. 50-68-12	99,80 €
	ABHR-D50x68-W32-L200-CC12	50-68	32	40	-	200	140	-	AK.. 50-68-12	119,80 €
	ABHR-D50x68-W32-L280-CC12	50-68	32	40	-	280	220	-	AK.. 50-68-12	150,00 €
	ABHR-D68x90-W32-L160-CC12	68-90	32	50	54	160	100	50	AK.. 68-90	110,10 €
	ABHR-D68x90-W32-L210-CC12	68-90	32	50	54	210	150	50	AK.. 68-90	131,90 €
	ABHR-D68x90-W32-L280-CC12	68-90	32	50	54	280	220	50	AK.. 68-90	165,30 €
	ABHR-D90x120-W32-L140-CC12	90-120	32	63	72	140	80	63	AK.. 90-120	120,50 €
	ABHR-D90x120-W40-L200-CC12	90-120	40	63	72	200	130	63	AK.. 90-120	130,80 €
	ABHR-D90x120-W40-L300-CC12	90-120	40	63	72	300	230	63	AK.. 90-120	156,90 €
	ABHR-D120x160-W40-L210-CC12	120-160	40	80	95	210	140	75	AK.. 120-160	206,40 €
	ABHR-D120x160-W40-L300-CC12	120-160	40	80	95	300	230	75	AK.. 120-160	247,60 €
	ABHR-D160x200-W40-L210-B-CC12	160-200	40	80	95	210	140	75	AK.. 160-800	209,00 €
ABHR-D160x200-W40-L300-B-CC12	160-200	40	80	95	300	230	75	AK.. 160-800	250,20 €	

AYARLI KABA DELİK İŞLEME BARA GÖVDELERİ

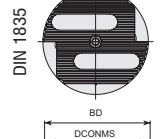
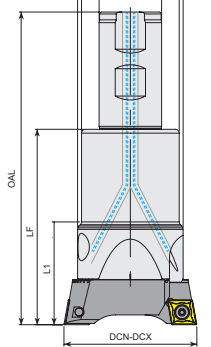
	TAKIM KODU	TAKIM ÖLÇÜLERİ (mm)							KARTUŞ	FİYAT
		DCN-DCX	DCON	DCONMS	BD	OAL	LF	L1		
  	ABHRS-D16x42-W16-L90	18-22	16	-	-	90	42	-	AK.. 18-22	41,20 €
	ABHRS-D16x102-W16-L150	18-22	16	-	-	150	102	-	AK.. 18-22	59,10 €
	ABHRS-D16x152-W16-L200	18-22	16	-	-	200	152	-	AK.. 18-22	85,80 €
	ABHRS-D20x50-W20-L100	22-28	20	-	-	100	50	-	AK.. 22-28	41,40 €
	ABHRS-D20x100-W20-L150	22-28	20	-	-	150	100	-	AK.. 22-28	59,70 €
	ABHRS-D20x150-W20-L200	22-28	20	-	-	200	150	-	AK.. 28-38	87,90 €
	ABHRS-D25x60-W20-L110	28-38	20	25	-	110	60	-	AK.. 28-38	39,20 €
	ABHRS-D25x110-W20-L160	28-38	20	25	-	160	110	-	AK.. 28-38	58,40 €
	ABHRS-D25x180-W20-L230	28-38	20	25	-	230	180	-	AK.. 28-38	86,90 €
	ABHRS-D32x64-W25-L120	36-50	25	32	-	120	64	-	AK.. 36-50	37,90 €
	ABHRS-D32x114-W25-L170	36-50	25	32	-	170	114	-	AK.. 36-50	57,30 €
	ABHRS-D32x194-W25-L250	36-50	25	32	-	250	194	-	AK.. 36-50	86,40 €
	ABHRS-D40x80-W32-L140	50-68	32	40	-	140	80	-	AK.. 50-68	37,70 €
	ABHRS-D40x140-W32-L200	50-68	32	40	-	200	140	-	AK.. 50-68	57,80 €
	ABHRS-D40x220-W32-L280	50-68	32	40	-	280	220	-	AK.. 50-68	87,90 €
	ABHRS-D50x100-W32-L160	68-90	32	50	54	160	100	50	AK.. 68-90	44,00 €
	ABHRS-D50x150-W32-L210	68-90	32	50	54	210	150	50	AK.. 68-90	65,70 €
	ABHRS-D50x220-W32-L280	68-90	32	50	54	280	220	50	AK.. 68-90	99,10 €
	ABHRS-D63x80-W32-L140	90-120	32	63	72	140	80	63	AK.. 90-120	51,70 €
	ABHRS-D63x130-W40-L200	90-120	40	63	72	200	130	63	AK.. 90-120	62,10 €
	ABHRS-D63x230-W40-L300	90-120	40	63	72	300	230	63	AK.. 90-120	88,10 €
	ABHRS-D80x140-W40-L210	120-160	40	80	95	210	140	75	AK.. 120-160	133,60 €
	ABHRS-D80x230-W40-L300	120-160	40	80	95	300	230	75	AK.. 120-160	174,80 €
	ABHRS-D80x140-W40-L210	160-200	40	80	95	210	140	75	AK.. 160-800	133,60 €
	ABHRS-D80x230-W40-L300	160-200	40	80	95	300	230	75	AK.. 160-800	174,80 €

AYARLI KABA DELİK İŞLEME BARA KARTUŞLARI

82/83

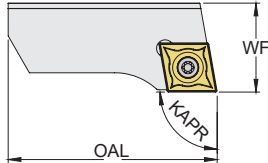
	TAKIM KODU	TAKIM ÖLÇÜLERİ (mm)			KESİCİ UÇ	FİYAT
		D _{min} / D _{max}	WF	OAL		
 	AKSR 18-22	18-22	9	15	CC.. 0602..	24,40 €
	AKSR 22-28	22-28	10	19	ISO	25,90 €
	AKSR 28-38	28-38	13	23		27,60 €
	AKSR 36-50	36-50	16	32		29,30 €
	AKSR 36-50-09	36-50	16	32	CC.. 09T3..	29,30 €
	AKSR 50-68	50-68	20	40	ISO	31,00 €
	AKSR 50-68-12	50-68	20	40		31,00 €
	AKSR 68-90	68-90	23	54	CC.. 1204..	33,20 €
	AKSR 90-120	90-120	28	70	ISO	34,50 €
	AKSR 120-160	120-160	33	95		36,40 €
	AKSR 160-800	160-800	33	130		37,70 €

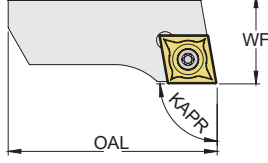
	TAKIM KODU	TAKIM ÖLÇÜLERİ (mm)			KESİCİ UÇ	FİYAT
		D _{min} / D _{max}	WF	OAL		
 	AKCR 28-38	28-38	12,8	23	CC.. 0602..	27,60 €
	AKCR 36-50	36-50	15,8	32	ISO	29,30 €
	AKCR 36-50-09	36-50	15,8	32	CC.. 09T3..	29,30 €
	AKCR 50-68	50-68	19,7	40	ISO	31,00 €
	AKCR 50-68-12	50-68	19,7	40	CC.. 1204..	31,00 €
	AKCR 68-90	68-90	22,7	54	ISO	33,20 €
	AKCR 90-120	90-120	27,7	70		34,50 €
	AKCR 120-160	120-160	32,7	95		36,40 €
	AKCR 160-800	160-800	32,7	130		37,70 €

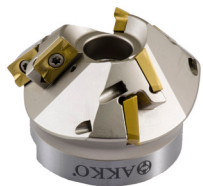

HELİS PAH FREZELEME TAKIMLARI

	TAKIM KODU	ZEFP		TAKIM ÖLÇÜLERİ (mm)						FİYAT
		Toplam	Etkili	KAPR	DC	DCX	DCON	APMX	LF	
	AHM15-AP16-D35x93-A27-Z0306-H	6	3	15	35	93	27	8	50	194,00 €
	AHM30-AP16-D35x87-A27-Z0306-H	6	3	30	35	87	27	15	50	194,00 €
	AHM45-AP16-D35x77-A27-Z0306-H	6	3	45	35	77	27	21,5	50	194,00 €
	AHM60-AP16-D35x65-A22-Z0306-H	6	3	60	35	65	22	26,5	50	194,00 €
	AHM75-AP16-D35x50-A22-Z0306-H	6	3	75	35	50	22	29,5	50	194,00 €

SİLİNDİRİK ALYAN BAŞLI VİDA (DIN 974-1) HAVŞALARINI AÇMA FREZELERİ

	TAKIM KODU	TAKIM ÖLÇÜLERİ (mm)						FİYAT
		DC	DCX	DCON	LH	LF	Kullanılan Vidalar	
	ACBM-CC06-D17X6-W16-L150-Z02	6	17	16	30	150	-	39,90 €
	ACBM-CC06-D18X7-W16-L100-Z02-H	7	18	16	32	100	M10	31,50 €
	ACBM-CC06-D18X7-W16-L160-Z02-H	7	18	16	32	160	M10	42,70 €
	ACBM-CC06-D20X9-W20-L100-Z02-H	9	20	20	40	100	M12	33,80 €
	ACBM-CC06-D20X9-W20-L160-Z02-H	9	20	20	38	160	M12	45,50 €
	ACBM-CC09-D26X8.5-W25-L130-Z02-H	8,5	26	25	50	130	M16	36,40 €
	ACBM-CC09-D26X8.5-W25-L200-Z02	8,5	26	25	50	200	M16	48,30 €
	ACBM-CC09-D26X8.5-W25-L200-Z02-H	8,5	26	25	50	200	M16	58,00 €
	ACBM-CC09-D30X12.5-W32-L130-Z02-H	12,5	30	32	65	130	-	40,10 €
	ACBM-CC09-D33X15.5-W32-L130-Z02-H	15,5	33	32	65	130	M20	40,10 €
	ACBM-CC09-D33X15.5-W32-L200-Z02	15,5	33	32	65	200	M20	54,10 €
	ACBM-CC09-D33X15.5-W32-L200-Z02-H	15,5	33	32	65	200	M20	64,90 €
	ACBM-SP06-D15X4-W16-L160-Z02-H	4	15	16	80	160	M8	42,70 €

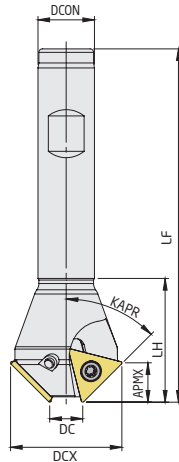
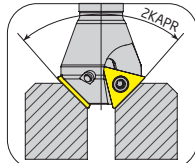
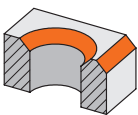
S-SİSTEM PAH FREZELER

	TAKIM KODU	TAKIM ÖLÇÜLERİ (mm)								KESİCİ UÇ	FİYAT
		KAPR	DC	DCX	DCON	LF	LH	ZEFP	APMX		
   	ACM10-TC16-D17X22-W16-L90-Z01	10°	17	22	16	90	30	1	15.2		20,90 €
	ACM15-TC16-D17X24-W16-L90-Z01	15°	17	24	16	90	30	1	14.9		20,90 €
	ACM15-TC16-D22X29-W16-L100-Z01	15°	22	29	16	100	30	1	14.9		31,00 €
	ACM15-TC16-D30X37-W20-L100-Z02	15°	30	37	20	100	35	2	14.9		34,90 €
	ACM15-TC16-D35X42-W20-L100-Z03	15°	35	42	20	100	38	3	14.9		38,80 €
	ACM15-TC16-D52X59-W25-L110-Z03	15°	52	59	25	110	40	3	14.9		38,80 €
	ACM17.5-TC16-D17X25-W16-L90-Z01	17.5°	17	25	16	90	30	1	14.7		20,90 €
	ACM18.5-TC16-D21.3X30-W20-L100-Z02	18.5°	21.3	30	20	100	30	2	13.5		20,90 €
	ACM20-TC16-D12X22-W16-L100-Z01	20°	12	22	16	100	30	1	14.4		20,90 €
	ACM20-TC16-D17X27-W16-L100-Z01	20°	17	27	16	100	30	1	14.4		20,90 €
	ACM20-TC16-D23X33-W20-L100-Z02	20°	23	33	20	100	30	2	14.4		34,90 €
	ACM20-TC16-D28X38-W20-L100-Z02	20°	28	38	20	100	35	2	14.4	TC.T 16T304	34,90 €
	ACM20-TC16-D35X45-W20-L100-Z03	20°	35	45	20	100	40	3	14.4	ISO	38,80 €
	ACM20-TC16-D39X49-W20-L100-Z03	20°	39	49	20	100	40	3	14.4		38,80 €
	ACM20-TC16-D45X55-W25-L110-Z03	20°	45	55	25	110	40	3	14.4		38,80 €
	ACM20-TC16-D51X61-W25-L110-Z03	20°	51	61	25	110	40	3	14.4		38,80 €
	ACM22.5-TC16-D17X28-W16-L100-Z01	22.5°	17	28	16	100	30	1	14.2		20,90 €
	ACM25-TC16-D17X29-W16-L100-Z01	25°	17	29	16	100	30	1	13.9		20,90 €
	ACM30-TC16-D6X20-W16-L100-Z01	30°	6	20	16	100	30	1	13.3		20,90 €
	ACM30-TC16-D15X30-W16-L100-Z01	30°	15	30	16	100	30	1	13.3		31,00 €
	ACM30-TC16-D17.5X32.5-W20-L100-Z02	30°	17.5	32.5	20	100	30	2	13.3		20,90 €
	ACM30-TC16-D20X35-W16-L100-Z02	30°	20	35	16	100	35	2	13.3		20,90 €
	ACM30-TC16-D30X45-W20-L100-Z02	30°	30	45	20	100	40	2	13.3		20,90 €
	ACM30-TC16-D35X50-W20-L100-Z03	30°	35	50	20	100	40	3	13.3		38,80 €
	ACM30-TC16-D45X60-W25-L110-Z03	30°	45	60	25	110	40	3	13.3		38,80 €
	ACM45-TC09-D7X18-W16-L100-Z02	45°	7	18	16	100	25	2	5.9	TC.T 090204	20,90 €
	ACM45-TC11-D11X24-W16-L100-Z02	45°	11	24	16	100	25	2	6.9	TC.T 110204	20,90 €
	ACM45-TC16-D5X26-W16-L100-Z01	45°	5	26	16	100	30	1	10.8		20,90 €
	ACM45-TC16-D10X31-W16-L100-Z02	45°	10	31	16	100	35	2	10.8		20,90 €
	ACM45-TC16-D10X31-W20-L100-Z02	45°	10	31	20	100	35	2	10.8		20,90 €
ACM45-TC16-D18X39-W16-L100-Z02	45°	18	39	16	100	40	2	10.8		20,90 €	
ACM45-TC16-D18X39-W20-L100-Z02	45°	18	39	20	100	40	2	10.8	TC.T 16T304	20,90 €	
ACM45-TC16-D20X41-W20-L100-Z02	45°	20	41	20	100	40	2	10.8	ISO	20,90 €	
ACM45-TC16-D30X51-W20-L100-Z02	45°	30	51	20	100	40	2	10.8		20,90 €	
ACM55-TC16-D16X40-W20-L100-Z03	55°	16	40	20	100	40	3	8.7		36,40 €	
ACM62-TC16-D14X40-W20-L100-Z03	62°	14	40	20	100	40	3	7.1		36,40 €	
ACM72-TC16-D14X42-W20-L100-Z03	72°	14	42	20	100	40	3	4.6		36,40 €	
	ACM45-SP1104-D12x26-W20-L150-Z01	45°	12	26	20	150	30	1	-	SPGT	27,60 €
	ACM45-SP1104-D25x39-W25-L150-Z02	45°	25	39	25	150	35	2	-	110408	34,50 €
	ACM45-SP1104-D32x46-W32-L150-Z03	45°	32	46	32	150	40	3	-	ZCC UCUNA UYGUNDUR.	41,40 €

Kesme Hesabı : S 142

Sipariş Örneği: 1 ad. ACM10-TC16-D17X22-W16-L90-Z01



S SISTEM YÜZEY PARMAK FREZELER

	TAKIM KODU	TAKIM ÖLÇÜLERİ (mm)						KESİCİ UÇ	FİYAT
		DC	ZEFP	DCON	LF	LH	APMX		
	AEM90-AD07-D10-C08-L90-Z02-H	10	2	8	90	16	6	ADMX 0702..	42,70 €
	AEM90-AD07-D10-C10-L80-Z02-H	10	2	10	80	16	6	PRMT UCUNA	42,70 €
	AEM90-AD07-D12-C10-L80-Z03-H	12	3	10	80	18	6	UYGUNDUR.	47,60 €
	AEM90-AD07-D12-C12-L90-Z03-H	12	3	12	90	18	6		52,70 €
	AEM90-AD07-D16-C16-L110-Z04-H	16	4	16	110	19	6		68,00 €
	AEM90-AD07-D20-C20-L125-Z05-H	20	5	20	125	20	6		84,80 €
	AEM90-AD07-D25-C25-L140-Z06-H	25	6	25	140	24	6		103,30 €
	AEM90-AD11-D16-C16-L135-Z02-H	16	2	16	135	24	9		36,90 €
	AEM90-AD11-D18-C16-L135-Z02-H	18	2	16	135	15	9		36,90 €
	AEM90-AD11-D18-C16-L160-Z02-H	18	2	16	160	15	9		44,60 €
	AEM90-AD11-D20-C20-L150-Z02-H	20	2	20	150	50	9		41,90 €
	AEM90-AD11-D20-C20-L150-Z03-H	20	3	20	150	50	9		53,40 €
	AEM90-AD11-D22-C20-L150-Z03-H	22	3	20	150	15	9	ADMX 11T30..	53,40 €
	AEM90-AD11-D22-C20-L200-Z03-H	22	3	20	200	15	9	PRMT UCUNA	80,10 €
	AEM90-AD11-D25-C25-L170-Z03-H	25	3	25	170	50	9	UYGUNDUR.	72,30 €
	AEM90-AD11-D25-C25-L170-Z04-H	25	4	25	170	50	9		80,20 €
	AEM90-AD11-D28-C25-L165-Z04-H	28	4	25	165	17	9		68,10 €
	AEM90-AD11-D28-C25-L200-Z04-H	28	4	25	200	17	9		92,90 €
AEM90-AD11-D30-C25-L165-Z04-H	30	4	25	165	19	9		68,10 €	
AEM90-AD11-D30-C25-L200-Z04-H	30	4	25	200	19	9		92,90 €	
AEM90-AD11-D32-C32-L195-Z05-H	32	5	32	195	50	9		99,10 €	
	AEM90-AD1505-D25-W25-L150-Z02	25	2	25	150	50	15	AD.. 1505..	41,60 €
	AEM90-AD1505-D30-W25-L150-Z03	30	3	25	150	50	15	ISCR UCUNA	47,80 €
	AEM90-AD1505-D32-W32-L150-Z03	32	3	32	150	50	15	UYGUNDUR.	47,80 €
	AEM90-AD0803-D16-W16-L150-Z02	16	2	16	150	30	8		34,50 €
	AEM90-AD0803-D17-W16-L150-Z02	17	2	16	150	30	8	ADMT 0803..	34,50 €
	AEM90-AD0803-D17-W16-L200-Z02	17	2	16	200	30	8	WLTR UCUNA	51,70 €
	AEM90-AD0803-D20-W20-L150-Z03	20	3	20	150	30	8	UYGUNDUR.	41,40 €
	AEM90-AD0803-D21-W20-L200-Z03	21	3	20	200	30	8		62,10 €
	AEM90-AD10T3-D16-W16-L100-Z02-H	16	2	16	100	30	10		34,50 €
	AEM90-AD10T3-D16-W16-L150-Z02	16	2	16	150	40	10		34,50 €
	AEM90-AD10T3-D16-C16-L200-Z02	16	2	16	200	50	10		64,20 €
	AEM90-AD10T3-D17-W16-L150-Z02	17	2	16	150	30	10		34,50 €
	AEM90-AD10T3-D17-W16-L200-Z02	17	2	16	200	30	10		51,70 €
	AEM90-AD10T3-D20-W20-L70-Z03	20	3	20	70	30	10	ADMT 10T3..	37,50 €
	AEM90-AD10T3-D20-W20-L100-Z03-H	20	3	20	100	30	10	WLTR UCUNA	41,40 €
	AEM90-AD10T3-D20-W20-L150-Z03	20	3	20	150	30	10	UYGUNDUR.	41,40 €
	AEM90-AD10T3-D20-C20-L150-Z03	20	3	20	150	40	10		41,40 €
	AEM90-AD10T3-D20-C20-L200-Z03	20	3	20	200	40	10		75,40 €
	AEM90-AD10T3-D25-W25-L100-Z03-H	25	3	25	100	30	10		43,10 €
	AEM90-AD10T3-D25-W25-L100-Z04-H	25	4	25	100	30	10		51,30 €
	AEM90-AD10T3-D25-W25-L150-Z03	25	3	25	150	50	10		43,10 €
	AEM90-AD1204-D20-W20-L150-Z02	20	2	20	150	50	12		37,50 €
	AEM90-AD1204-D21-C20-L150-Z02	21	2	20	150	30	12	ADMT 1204..	37,50 €
	AEM90-AD1204-D22-C20-L150-Z02	22	2	20	150	30	12	WLTR UCUNA	37,50 €
	AEM90-AD1204-D25-W25-L150-Z03	25	3	25	150	50	12	UYGUNDUR.	43,80 €
	AEM90-AD1204-D26-W25-L180-Z03	26	3	25	180	35	12		55,80 €
	AEM90-AD1204-D32-W32-L150-Z04	32	4	32	150	50	12		50,20 €
	AEM90-AD1606-D25-W25-L150-Z02	25	2	25	150	50	15	ADMT 1606..	43,80 €
	AEM90-AD1606-D32-W32-L150-Z03	32	3	32	150	50	15	WLTR UCUNA	50,20 €
								UYGUNDUR.	

S SİSTEM YÜZEY PARMAK FREZELER

	TAKIM KODU	TAKIM ÖLÇÜLERİ (mm)						KESİCİ UÇ	FİYAT
		DC	ZEFP	DCON	LF	LH	APMX		
	AEM90-AD1003-D16-C16-L150-Z02	16	2	16	150	30	8		31,50 €
	AEM90-AD1003-D17-C16-L150-Z02	17	2	16	150	25	8		31,50 €
	AEM90-AD1003-D20-C20-L200-Z03	20	3	20	200	50	8	ADMT 1003..	58,00 €
	AEM90-AD1003-D21-C20-L150-Z03	21	3	20	150	25	8	DJT UCUNA	37,70 €
	AEM90-AD1003-D21-C20-L200-Z03	21	3	20	200	25	8	UYGUNDUR.	58,00 €
	AEM90-AD1003-D25-C25-L200-Z03	25	3	25	200	50	8		61,90 €
	AEM90-AD1003-D26-C25-L150-Z03	26	3	25	150	30	8		37,70 €
	AEM90-AD1003-D26-C25-L200-Z03	26	3	25	200	30	8		61,90 €
	AEM90-AD1505D-D25-W25-L150-Z02	25	2	25	150	50	14.3	ADKT 150508	41,60 €
	AEM90-AD1505D-D32-W32-L150-Z03	32	3	32	150	50	14.3	DJT UCUNA UYGUNDUR.	47,80 €
90°									
	AEM90-AN11-D22-W20-L150-Z02	22	2	20	150	30	11		45,00 €
	AEM90-AN11-D25-W25-L150-Z02	25	2	25	150	40	11		45,00 €
	AEM90-AN11-D25-C25-L200-Z02	25	2	25	200	40	11		62,10 €
	AEM90-AN11-D26-W25-L150-Z02	26	2	25	150	40	11	ANGX 110508	47,00 €
	AEM90-AN11-D28-W25-L150-Z02	28	2	25	150	25	11	ZCC UCUNA	47,00 €
	AEM90-AN11-D32-W32-L150-Z03	32	3	32	150	50	11	UYGUNDUR.	52,80 €
	AEM90-AN11-D32-C32-L200-Z03	32	3	32	200	50	11		72,20 €
	AEM90-AN11-D40-W32-L150-Z04	40	4	32	150	40	11		58,40 €
90°									
	AEM90-AN1207-D25-W25-L150-Z02	25	2	25	150	40	10	ANKX 1207..	45,00 €
	AEM90-AN1207-D32-W32-L150-Z03	32	3	32	150	50	10	XTC-GSC UCUNA	52,80 €
	AEM90-AN1207-D40-W32-L150-Z04	40	4	32	150	40	10	UYGUNDUR.	58,40 €
90°									
	AEM90-AN1607-D32-C25-L150-Z02	32	2	25	150	40	15	AN.X 1607..	41,60 €
	AEM90-AN1607-D40-C32-L150-Z03	40	3	32	150	45	15	TGTC UCUNA UYGUNDUR.	52,20 €
90°									

Kesme Hesabı : S 142

Sipariş Örneği: 1 ad. AEM90-AD1003-D16-C16-L150-Z02



S SİSTEM YÜZEY PARMAK FREZELER

	TAKIM KODU	TAKIM ÖLÇÜLERİ (mm)						KESİCİ UÇ	FİYAT
		DC	ZEFP	DCON	LF	LH	APMX		
	AEM90-AP06-D10-C10-L120-Z02	10	2	10	120	20	5,6	APMT 0602..	42,70 €
	AEM90-AP06-D12-C12-L120-Z02	12	2	12	120	20	5,6	KRLY UCUNA UYGUNDUR.	42,70 €
	YENI AEM90-AP0903-D12-C16-L080-Z01-H	12	1	16	80	30	9		32,20 €
	YENI AEM90-AP0903-D16-C16-L090-Z02	16	2	16	90	30	9		36,40 €
	AEM90-AP0903-D16-C16-L150-Z02	16	2	16	150	30	9		36,40 €
	AEM90-AP0903-D17-C16-L150-Z02	17	2	16	150	30	9		36,40 €
	YENI AEM90-AP0903-D18-C16-L090-Z02-H	18	2	16	90	30	9	APMT 0903..	36,40 €
	YENI AEM90-AP0903-D20-C20-L110-Z03	20	3	20	110	30	9	KRLY UCUNA	44,40 €
	AEM90-AP0903-D20-C20-L150-Z02	20	2	20	150	30	9	UYGUNDUR.	40,10 €
	YENI AEM90-AP0903-D20-C20-L200-Z02	20	2	20	200	100	9		53,50 €
	AEM90-AP0903-D21-C20-L150-Z02	21	2	20	150	30	9		40,10 €
	YENI AEM90-AP0903-D25-C25-L120-Z03	25	3	25	120	30	9		44,40 €
	AEM90-AP0903-D25-C25-L150-Z03	25	3	25	150	30	9		44,40 €
	YENI AEM90-AP0903-D25-C25-L200-Z02	25	2	25	200	100	9		53,50 €
	AEM90-AP09-D16-C16-L100-Z02-H	16	2	16	100	30	8,8		31,50 €
	AEM90-AP09-D16-C15-L150-Z02	16	2	15	150	25	8,8		36,40 €
	AEM90-AP09-D16-W16-L150-Z02-H	16	2	16	150	25	8,8		38,80 €
	AEM90-AP09-D16-C16-L200-Z02-H	16	2	16	200	100	8,8		65,50 €
	AEM90-AP09-D17-C16-L150-Z02	17	2	16	150	25	8,8	APKT 09T3..	36,40 €
	AEM90-AP09-D17-C16-L180-Z02-H	17	2	16	180	25	8,8	TGTC UCUNA	56,60 €
	AEM90-AP09-D20-C20-L150-Z03-H	20	3	20	150	50	8,8	UYGUNDUR.	41,60 €
	AEM90-AP09-D20-C20-L200-Z03-H	20	3	20	200	100	8,8		71,60 €
	AEM90-AP09-D20-C20-L250-Z02-H	20	2	20	250	150	8,8		99,60 €
	AEM90-AP09-D21-C20-L150-Z03	21	3	20	150	25	8,8		42,70 €
	AEM90-AP09-D26-C25-L150-Z04	26	4	25	150	30	8,8		48,30 €
	YENI AEM90-AP10-D10-C10-L100-Z01	10	1	10	100	20	10		28,00 €
	YENI AEM90-AP10-D12-C16-L100-Z01-H	12	1	16	100	30	10		28,00 €
	AEM90-AP10-D12-W16-L100-Z01-H	12	1	16	100	30	10		28,00 €
	AEM90-AP10-D12-W16-L150-Z01	12	1	16	150	38	10		28,00 €
	AEM90-AP10-D14-W16-L100-Z01-H	14	1	16	100	30	10		28,00 €
	AEM90-AP10-D14-W16-L150-Z01	14	1	16	150	38	10		28,00 €
	AEM90-AP10-D16-C16-L100-Z02-H	16	2	16	100	30	10		31,50 €
	AEM90-AP10-D16-W16-L100-Z02-H	16	2	16	100	30	10		31,50 €
	AEM90-AP10-D16-C16-L120-Z02-H	16	2	16	120	30	10		31,50 €
	AEM90-AP10-D16-C16-L150-Z02	16	2	16	150	50	10	AP. 1003..	31,50 €
	AEM90-AP10-D16-C16-L150-Z02-H	16	2	16	150	50	10	ISO	36,40 €
	AEM90-AP10-D16-W16-L150-Z02	16	2	16	150	50	10		31,50 €
	AEM90-AP10-D16-C16-L200-Z02	16	2	16	200	100	10		47,80 €
	AEM90-AP10-D16-C16-L200-Z02-H	16	2	16	200	100	10		57,30 €
	YENI AEM90-AP10-D16-W16-L200-Z02	16	2	16	200	100	10		47,80 €
AEM90-AP10-D16-C16-L250-Z02	16	2	16	250	50	10		71,10 €	
AEM90-AP10-D18-W16-L100-Z02-H	18	2	16	100	30	10		31,50 €	
AEM90-AP10-D18-W16-L150-Z02	18	2	16	150	30	10		31,50 €	
AEM90-AP10-D20-C20-L100-Z03-H	20	3	20	100	30	10		37,70 €	
AEM90-AP10-D20-W20-L100-Z03-H	20	3	20	100	30	10		37,70 €	
AEM90-AP10-D20-C20-L120-Z03-H	20	3	20	120	30	10		37,70 €	
AEM90-AP10-D20-C20-L150-Z03	20	3	20	150	50	10		37,70 €	

90°

S SİSTEM YÜZEY PARMAK FREZELER

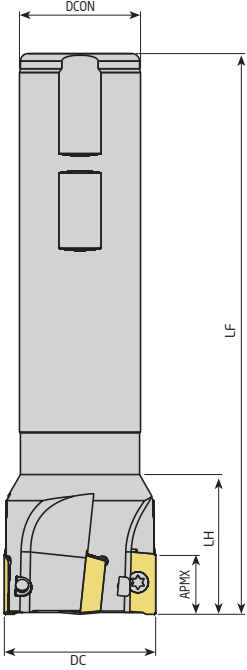
	TAKIM KODU	TAKIM ÖLÇÜLERİ (mm)						KESİCİ UÇ	FİYAT
		DC	ZEFP	DCON	LF	LH	APMX		
  90°	AEM90-AP10-D20-C20-L150-Z03-H	20	3	20	150	50	10		41,60 €
	AEM90-AP10-D20-W20-L150-Z03	20	3	20	150	50	10		37,70 €
	AEM90-AP10-D20-C20-L200-Z02	20	2	20	200	100	10		55,80 €
	AEM90-AP10-D20-C20-L200-Z03-H	20	3	20	200	100	10		71,60 €
	AEM90-AP10-D20-C20-L250-Z02	20	2	20	250	150	10		78,40 €
	AEM90-AP10-D20-C20-L250-Z02-H	20	2	20	250	150	10		99,60 €
	AEM90-AP10-D21-W20-L150-Z03	21	3	20	150	30	10		37,70 €
	NEW AEM90-AP10-D21-C20-L200-Z03	21	3	20	200	30	10		61,90 €
	AEM90-AP10-D22-W20-L100-Z03-H	22	3	20	100	30	10		37,70 €
	AEM90-AP10-D22-W20-L150-Z03	22	3	20	150	30	10		37,70 €
	AEM90-AP10-D23-W20-L150-Z03	23	3	20	150	30	10		37,70 €
	AEM90-AP10-D24-W20-L150-Z03	24	3	20	150	30	10		37,70 €
	AEM90-AP10-D25-W25-L100-Z04-H	25	4	25	100	30	10		44,20 €
	AEM90-AP10-D25-C25-L100-Z03-H	25	3	25	100	30	10		37,70 €
	AEM90-AP10-D25-W25-L100-Z03-H	25	3	25	100	30	10		37,70 €
	AEM90-AP10-D25-C25-L120-Z03-H	25	3	25	120	30	10	AP. 1003..	37,70 €
	AEM90-AP10-D25-C25-L150-Z03	25	3	25	150	50	10	ISO	37,70 €
	AEM90-AP10-D25-W25-L150-Z03	25	3	25	150	50	10		37,70 €
	AEM90-AP10-D25-C25-L200-Z02	25	2	25	200	100	10		55,80 €
	AEM90-AP10-D25-C25-L200-Z03	25	3	25	200	100	10		61,90 €
	AEM90-AP10-D25-C25-L250-Z02	25	2	25	250	100	10		71,60 €
	AEM90-AP10-D30-C25-L100-Z04-H	30	4	25	100	30	10		44,20 €
	AEM90-AP10-D30-C25-L120-Z04-H	30	4	25	120	30	10		44,20 €
	AEM90-AP10-D30-C25-L150-Z04	30	4	25	150	30	10		44,20 €
	AEM90-AP10-D32-C25-L100-Z04-H	32	4	25	100	35	10		44,20 €
	AEM90-AP10-D32-C25-L120-Z04-H	32	4	25	120	35	10		44,20 €
	AEM90-AP10-D32-C25-L150-Z04	32	4	25	150	35	10		44,20 €
	AEM90-AP10-D32-W25-L150-Z04	32	4	25	150	35	10		44,20 €
	NEW AEM90-AP10-D32-C32-L130-Z05	32	5	32	130	30	10		48,20 €
	AEM90-AP10-D32-W32-L150-Z04	32	4	32	150	50	10		44,20 €
	AEM90-AP10-D40-W32-L150-Z05	40	5	32	150	40	10		49,40 €
	AEM90-AP10D-D16-W16-L150-Z02	16	2	16	150	50	10	AP. 1003..	31,50 €
	AEM90-AP10D-D20-W20-L150-Z03	20	3	20	150	50	10	DJT UCUNA	37,70 €
	NEW AEM90-AP10D-D25-W20-L150-Z03	25	3	20	150	30	10	UYGUNDUR.	37,70 €
	AEM90-AP100-D16-C15-L150-Z02	16	2	15	150	30	10		34,70 €
	AEM90-AP100-D21-C20-L150-Z03	21	3	20	150	30	10	AP. 1003..	41,60 €
	AEM90-AP100-D26-C25-L150-Z04	26	4	25	150	35	10	B.OKE UCUNA	46,90 €
	AEM90-AP100-D33-C32-L200-Z05	33	5	32	200	50	10	UYGUNDUR.	72,60 €
	AEM90-AP10S-D16-W16-L150-Z02	16	2	16	150	26	10	AP. 1003..	34,70 €
	AEM90-AP10S-D20-W20-L150-Z02	20	2	20	150	26	10	SMTM UCUNA	37,10 €
	AEM90-AP10S-D25-W25-L150-Z03	25	3	25	150	26	10	UYGUNDUR.	41,60 €
	AEM90-AP11-D16-C16-L150-Z02	16	2	16	150	50	11		31,50 €
	AEM90-AP11-D16-C16-L150-Z02-H	16	2	16	150	50	11		36,40 €
	AEM90-AP11-D16-W16-L150-Z02	16	2	16	150	50	11	AP. 11T3..	31,50 €
	AEM90-AP11-D16-W16-L150-Z02-H	16	2	16	150	50	11	ZCC UCUNA	36,40 €
AEM90-AP11-D16-C16-L200-Z02	16	2	16	200	100	11	UYGUNDUR.	47,80 €	
AEM90-AP11-D17-C16-L150-Z02	17	2	16	150	30	11		36,40 €	
AEM90-AP11-D17-C16-L200-Z02	17	2	16	200	30	11		51,90 €	
AEM90-AP11-D20-C20-L150-Z03	20	3	20	150	50	11		37,70 €	

SİSTEM YÜZEY PARMAK FREZELER

	TAKIM KODU	TAKIM ÖLÇÜLERİ (mm)						KESİCİ UÇ	FİYAT
		DC	ZEFP	DCON	LF	LH	APMX		
	AEM90-AP11-D20-W20-L150-Z03	20	3	20	150	50	11		37,70 €
	AEM90-AP11-D20-W20-L150-Z03-H	20	3	20	150	50	11		44,20 €
	AEM90-AP11-D20-C20-L200-Z03	20	3	20	200	100	11		61,90 €
	AEM90-AP11-D21-C20-L150-Z03	21	3	20	150	30	11		37,70 €
	AEM90-AP11-D21-W20-L150-Z03	21	3	20	150	30	11		37,70 €
	AEM90-AP11-D21-W20-L150-Z03-H	21	3	20	150	30	11		44,20 €
	AEM90-AP11-D21-C20-L200-Z03	21	3	20	200	30	11	AP. 11T3..	68,10 €
	AEM90-AP11-D25-C25-L150-Z03	25	3	25	150	50	11	ZCC UCUNA	37,70 €
	AEM90-AP11-D25-W25-L150-Z03	25	3	25	150	50	11	UYGUNDUR.	37,70 €
	AEM90-AP11-D25-W25-L150-Z03-H	25	3	25	150	50	11		44,20 €
	AEM90-AP11-D26-C25-L150-Z03	26	3	25	150	35	11		41,60 €
	AEM90-AP11-D26-C24-L150-Z03	26	3	24	150	47	11		41,60 €
	AEM90-AP11-D32-W25-L150-Z04	32	4	25	150	35	11		44,20 €
	AEM90-AP11-D32-W32-L150-Z03-H	32	3	32	150	50	11		49,40 €
	AEM90-AP11-D32-W32-L150-Z04	32	4	32	150	50	11		44,20 €
	AEM90-AP1135A-D14-C16-L150-Z01	14	1	16	150	40	9.5		30,80 €
	AEM90-AP1135A-D16-C16-L150-Z02	16	2	16	150	40	9.5		34,70 €
	AEM90-AP1135A-D16-C16-L200-Z02	16	2	16	200	100	9.5		52,80 €
	AEM90-AP1135A-D16-C16-L250-Z02	16	2	16	250	150	9.5		78,40 €
	AEM90-AP1135A-D17-C16-L180-Z02	17	2	16	180	30	9.5	APMT 1135..	48,10 €
	AEM90-AP1135A-D20-C20-L150-Z03	20	3	20	150	50	9.5	ACHTK UCUNA	41,60 €
	AEM90-AP1135A-D20-C20-L200-Z02	20	2	20	200	100	9.5	UYGUNDUR.	52,80 €
	AEM90-AP1135A-D21-C20-L180-Z02	21	2	20	180	30	9.5		48,10 €
	AEM90-AP1135A-D25-C25-L200-Z03	25	3	25	200	100	9.5		68,10 €
	AEM90-AP1135A-D26-C25-L250-Z02	26	2	25	250	35	9.5		69,60 €
	AEM90-AP1135A-D33-C32-L250-Z02	33	2	32	250	35	9.5		69,60 €
	AEM90-AP110-D16-C15-L150-Z02	16	2	15	150	30	11	APMT 1135..	34,70 €
	AEM90-AP110-D21-C20-L150-Z03	21	3	20	150	30	11	B.OKE UCUNA	41,60 €
	AEM90-AP110-D26-C25-L150-Z04	26	4	25	150	35	11	UYGUNDUR.	46,90 €
	AEM90-AP110-D33-C32-L200-Z05	33	5	32	200	50	11		72,60 €
	AEM90-APK11G-D16-W16-L150-Z02	16	2	16	150	26	11	APKT 1135..	34,70 €
	AEM90-APK11G-D20-W20-L150-Z03	20	3	20	150	26	11	XTC-GSC UCUNA	41,60 €
	AEM90-APK11G-D25-W25-L150-Z03	25	3	25	150	26	11	UYGUNDUR.	43,50 €
YENİ AEM90-AP1135-D16-W16-L110-Z02-H	16	2	16	110	30	9.5		34,70 €	
AEM90-AP1135-D16-W16-L150-Z02	16	2	16	150	50	9.5		34,70 €	
YENİ AEM90-AP1135-D20-W20-L125-Z03-H	20	3	20	125	30	9.5	AP. 1135..	41,60 €	
AEM90-AP1135-D20-W20-L150-Z03	20	3	20	150	50	9.5	XTC-GSC UCUNA	41,60 €	
YENİ AEM90-AP1135-D25-W25-L125-Z04-H	25	4	25	125	30	9.5	UYGUNDUR.	44,20 €	
YENİ AEM90-AP1135-D25-W25-L200-Z04-H	25	4	25	200	100	9.5		66,30 €	
YENİ AEM90-AP1135-D32-W32-L125-Z05-H	32	5	32	125	30	9.5		48,20 €	
YENİ AEM90-AP1135-D32-W32-L200-Z04-H	32	4	32	200	100	9.5		72,90 €	
YENİ AEM90-AP1135Y-D16-C16-L120-Z02-H	16	2	16	120	30	9.5		36,80 €	
YENİ AEM90-AP1135Y-D16-W16-L150-Z02	16	2	16	150	50	9.5		34,70 €	
YENİ AEM90-AP1135Y-D17-C16-L150-Z02	17	2	20	150	30	9.5		34,70 €	
YENİ AEM90-AP1135Y-D20-C20-L120-Z02	20	2	20	120	30	9.5		37,60 €	
YENİ AEM90-AP1135Y-D20-W20-L150-Z03	20	3	20	150	50	9.5	APMT 1135..	41,60 €	
YENİ AEM90-AP1135Y-D21-C20-L150-Z03	21	3	25	150	30	9.5	YG UCUNA	41,60 €	
YENİ AEM90-AP1135Y-D25-W25-L150-Z03	25	3	25	150	35	9.5	UYGUNDUR.	43,50 €	
90° YENİ AEM90-AP1135Y-D25-C25-L150-Z04-H	25	4	25	150	30	9.5		59,20 €	
YENİ AEM90-AP1135Y-D26-C25-L150-Z03	26	3	25	150	35	9.5		43,50 €	
YENİ AEM90-AP1135Y-D32-W25-L110-Z04	32	4	25	110	35	9.5		48,60 €	

S SİSTEM YÜZEY PARMAK FREZELER

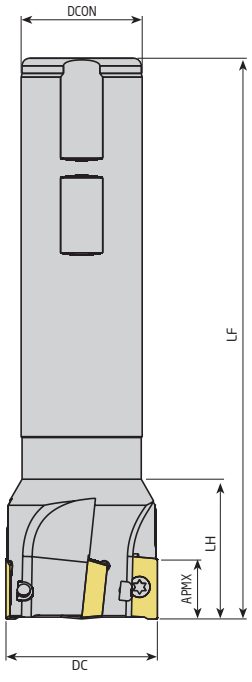

	TAKIM KODU	TAKIM ÖLÇÜLERİ (mm)						KESİCİ UÇ	FİYAT
		DC	ZEFP	DCON	LF	LH	APMX		
  90°	AEM90-AP1204-D20-C20-L150-Z02	20	2	20	150	30	16		44,20 €
	AEM90-AP1204-D21-C20-L150-Z02	21	2	20	150	30	16	AP.. 1204..	44,20 €
	AEM90-AP1204-D21-C20-L200-Z02	21	2	20	200	30	16	TGTC UCUNA	63,60 €
	AEM90-AP1204-D25-C25-L150-Z03	25	3	25	150	40	16	UYGUNDUR.	47,80 €
	AEM90-AP1204-D26-C25-L250-Z02	26	2	25	250	35	16		87,50 €
	AEM90-AP1204-D32-C25-L150-Z03	32	3	25	150	35	16		49,40 €
	AEM90-AP16-D25-C20-L100-Z02	25	2	20	100	35	16		36,40 €
	AEM90-AP16-D25-W25-L100-Z02-H	25	2	25	100	35	16		36,40 €
	AEM90-AP16-D25-W25-L150-Z02	25	2	25	150	50	16		36,40 €
	AEM90-AP16-D25-C25-L250-Z02	25	2	25	250	100	16		71,60 €
	AEM90-AP16-D28-W25-L100-Z03-H	28	3	25	100	40	16		40,10 €
	AEM90-AP16-D28-W25-L150-Z03	28	3	25	150	40	16		40,10 €
	AEM90-AP16-D30-W25-L110-Z03-H	30	3	25	110	40	16		40,10 €
	AEM90-AP16-D30-W25-L150-Z02	30	2	25	150	40	16		38,60 €
	AEM90-AP16-D30-W25-L150-Z03	30	3	25	150	40	16		40,10 €
	AEM90-AP16-D32-W32-L110-Z03-H	32	3	32	110	40	16		40,10 €
	AEM90-AP16-D32-C32-L150-Z03	32	3	32	150	50	16		40,10 €
	AEM90-AP16-D32-W25-L150-Z03	32	3	25	150	40	16	AP.. 1604..	40,10 €
	AEM90-AP16-D32-W32-L150-Z03	32	3	32	150	50	16	ISO	40,10 €
	AEM90-AP16-D32-W32-L150-Z03-H	32	3	32	150	50	16		48,10 €
	AEM90-AP16-D32-C25-L200-Z03-H	32	3	25	200	40	16		64,20 €
	AEM90-AP16-D32-C32-L250-Z02	32	3	32	250	100	16		71,60 €
	AEM90-AP16-D32-C32-L250-Z03	32	3	32	250	100	16		79,30 €
	AEM90-AP16-D35-W32-L150-Z03	35	3	32	150	40	16		41,60 €
	AEM90-AP16-D36-W32-L110-Z03-H	36	3	32	110	40	16		41,60 €
	AEM90-AP16-D36-W32-L150-Z03	36	3	32	150	40	16		41,60 €
	AEM90-AP16-D40-W32-L110-Z04-H	40	4	32	110	40	16		45,70 €
	AEM90-AP16-D40-C32-L150-Z04	40	4	32	150	40	16		45,70 €
	AEM90-AP16-D40-W32-L150-Z04	40	4	32	150	40	16		45,70 €
	AEM90-AP16-D40-C32-L250-Z02	40	2	32	250	40	16		75,90 €
	AEM90-AP16-D40-C32-L250-Z04	40	4	32	250	40	16		91,60 €
	YENİ AEM90-AP16DJ-D25-W25-L150-Z02	25	2	25	150	50	16		36,40 €
	YENİ AEM90-AP16DJ-D25-C25-L200-Z02	25	2	25	200	50	16	AP.. 1604..	55,80 €
	YENİ AEM90-AP16DJ-D32-W32-L150-Z03	32	3	32	150	50	16	DJT UCUNA	40,10 €
	YENİ AEM90-AP16DJ-D32-C32-L180-Z03	32	3	32	180	50	16	UYGUNDUR.	69,80 €
	YENİ AEM90-AP16DJ-D32-C32-L200-Z03	32	3	32	200	40	16		60,20 €
	AEM90-AP16D-D25-W25-L150-Z02	25	2	25	150	50	16		36,40 €
	AEM90-AP16D-D25-C25-L200-Z02	25	2	25	200	50	16	AP.. 1604..	55,80 €
	AEM90-AP16D-D32-W32-L150-Z03	32	3	32	150	50	16	DJT UCUNA	40,10 €
	AEM90-AP16D-D32-C32-L180-Z03	32	3	32	180	50	16	UYGUNDUR.	69,80 €
	AEM90-AP16D-D32-C32-L200-Z03	32	3	32	200	50	16		65,10 €
	AEM90-AP16L-D25-C25-L120-Z02-H	25	2	25	120	45	16		36,40 €
	AEM90-AP16L-D25-C25-L150-Z02	25	2	25	150	55	16		36,40 €
	AEM90-AP16L-D25-C25-L200-Z02	25	2	25	200	55	16		54,10 €
	AEM90-AP16L-D25-C25-L250-Z02	25	2	25	250	100	16		71,60 €
YENİ AEM90-AP16L-D30-W25-L120-Z03-H	30	3	25	120	40	16	AP.. 1604..	40,10 €	
AEM90-AP16L-D32-C32-L120-Z03-H	32	3	32	120	45	16	LMNA UCUNA	40,10 €	
AEM90-AP16L-D32-C32-L150-Z03	32	3	32	150	55	16	UYGUNDUR.	40,10 €	
AEM90-AP16L-D32-C32-L200-Z03	32	3	32	200	55	16		59,70 €	
AEM90-AP16L-D32-C32-L250-Z03	32	3	32	250	100	16		79,30 €	
AEM90-AP16L-D40-C32-L120-Z04-H	40	4	32	120	40	16		45,70 €	

S SİSTEM YÜZEY PARMAK FREZELER

90/91

	TAKIM KODU	TAKIM ÖLÇÜLERİ (mm)						KESİCİ UÇ	FİYAT
		DC	ZEFP	DCON	LF	LH	APMX		
	AEM90-AP16L-D40-C32-L150-Z04	40	4	32	150	40	16	AP. 1604..	45,70 €
	AEM90-AP16L-D40-C32-L200-Z04	40	4	32	200	40	16	LMN UCUNA	68,80 €
	AEM90-AP16L-D40-C32-L250-Z04	40	4	32	250	40	16	UYGUNDUR.	91,60 €
	AEM90-AP16P-D25-W25-L100-Z02-H	25	2	25	100	35	16		36,40 €
	AEM90-AP16P-D25-W25-L150-Z02	25	2	25	150	50	16	AP. 1604..	36,40 €
	AEM90-AP16P-D32-W32-L150-Z03	32	3	32	150	50	16	PLBT UCUNA	40,10 €
	AEM90-AP16P-D32-C32-L250-Z02	32	2	32	250	100	16	UYGUNDUR.	71,60 €
	AEM90-AP16P-D40-W32-L150-Z04	40	4	32	150	50	16		45,70 €
	YENİ AEM90-AP16Y-D25-C20-L100-Z02-H	25	2	20	100	35	16	AP. 1604..	41,00 €
	YENİ AEM90-AP16Y-D25-C25-L120-Z02	25	2	25	120	50	16	LMN UCUNA	41,00 €
	YENİ AEM90-AP16Y-D25-C25-L150-Z02	25	2	25	150	50	16	UYGUNDUR.	41,00 €
	YENİ AEM90-AP16Y-D25-C25-L250-Z02	25	2	25	250	100	16		78,80 €
	AEM90-AP1705-D25-C25-L120-Z02	25	2	25	120	40	16		49,40 €
	AEM90-AP1705-D26-C25-L200-Z02	26	2	25	200	40	16		73,30 €
	AEM90-AP1705-D26-C25-L250-Z02	26	2	25	250	40	16	AP. 1705..	97,20 €
	AEM90-AP1705-D26-C25-L300-Z02	26	2	25	300	40	16	TGTC-LMN	110,10 €
	AEM90-AP1705-D28-W25-L075-Z02	28	2	25	75	20	16	UCUNA	49,40 €
AEM90-AP1705-D32-C25-L150-Z03	32	3	25	150	40	16	UYGUNDUR.	53,90 €	
AEM90-AP1705-D33-C32-L250-Z03	33	3	32	250	40	16		111,20 €	
AEM90-AP1705-D33-C32-L300-Z02	33	2	32	300	40	16		113,40 €	
	AEM90-A01236-D16-C16-L85-Z02-H	16	2	16	85	30	12		43,80 €
	AEM90-A01236-D16-W16-L150-Z02	16	2	16	150	50	12		43,80 €
	YENİ AEM90-A01236-D20-C20-L100-Z02	20	2	20	100	30	12	AO. 1236..	46,60 €
	AEM90-A01236-D20-C20-L100-Z02-H	20	2	20	100	30	12	MTSBH UCUNA	46,60 €
	YENİ AEM90-A01236-D25-C25-L115-Z02	25	2	25	115	50	12	UYGUNDUR.	49,40 €
	AEM90-A01236-D25-C25-L115-Z02-H	25	2	25	115	30	12		49,40 €
	AEM90-A01236-D25-W25-L150-Z03	25	3	25	150	50	12		53,00 €
AEM90-A01236-D32-W32-L150-Z04	32	4	32	150	50	12		61,60 €	
	AEM90-AX0602-D10-C09-L120-Z02	10	2	9	120	15	5.7		42,70 €
	AEM90-AX0602-D10-C10-L080-Z02	10	2	10	80	20	5.7		42,70 €
	AEM90-AX0602-D10-C10-L120-Z02	10	2	10	120	20	5.7		42,70 €
	AEM90-AX0602-D12-C11-L120-Z02	12	2	11	120	15	5.7		42,70 €
	AEM90-AX0602-D12-C12-L080-Z02	12	2	12	80	20	5.7	AX.T 0602..	42,70 €
	AEM90-AX0602-D12-C12-L120-Z02	12	2	12	120	20	5.7	TGTC UCUNA	42,70 €
	AEM90-AX0602-D14-C12-L120-Z03	14	3	12	120	20	5.7	UYGUNDUR.	47,00 €
	AEM90-AX0602-D16-W16-L120-Z04-H	16	4	16	120	20	5.7		43,80 €
	AEM90-AX0602-D16-W16-L150-Z04-H	16	4	16	150	20	5.7		49,10 €
	AEM90-AX0602-D20-W20-L120-Z05-H	20	5	20	120	25	5.7		51,30 €
	AEM90-AX0602-D20-W20-L150-Z05-H	20	5	20	150	25	5.7		56,90 €
	AEM90-AX0903-D16-C16-L120-Z02	16	2	16	120	30	8.8		36,40 €
	AEM90-AX0903-D16-C16-L180-Z02	16	2	16	180	30	8.8		53,90 €
	AEM90-AX0903-D17-C16-L120-Z02	17	2	16	120	25	8.8		36,40 €
	AEM90-AX0903-D17-C16-L180-Z02	17	2	16	180	25	8.8		53,90 €
	AEM90-AX0903-D20-C20-L120-Z03	20	3	20	120	30	8.8	AX.T 0903..	44,20 €
	AEM90-AX0903-D20-C20-L200-Z02	20	2	20	200	30	8.8	TGTC UCUNA	63,60 €
	AEM90-AX0903-D21-C20-L120-Z03	21	3	20	120	25	8.8	UYGUNDUR.	44,20 €
	AEM90-AX0903-D21-C20-L200-Z02	21	2	20	200	25	8.8		63,60 €
	AEM90-AX0903-D25-C25-L150-Z03	25	3	25	150	30	8.8		44,20 €
	AEM90-AX0903-D25-C25-L250-Z02	25	2	25	250	40	8.8		87,50 €
	AEM90-AX0903-D26-C25-L150-Z03	26	3	25	150	30	8.8		44,20 €



S SİSTEM YÜZEY PARMAK FREZELER

	TAKIM KODU	TAKIM ÖLÇÜLERİ (mm)						KESİCİ UÇ	FİYAT
		DC	ZEFP	DCON	LF	LH	APMX		
	AEM90-BD11T3-D16-C15-L180-Z02	16	2	16	100	30	10		45,50 €
	AEM90-BD11T3-D16-C16-L100-Z02-H	16	2	16	100	30	10		34,50 €
	AEM90-BD11T3-D16-W16-L100-Z02-H	16	2	16	150	50	10		34,50 €
	AEM90-BD11T3-D16-W16-L150-Z02	16	2	15	180	50	10		34,50 €
	YENİ AEM90-BD11T3-D16-C16-L160-Z02-H	16	2	16	160	50	10		41,40 €
	AEM90-BD11T3-D17-W16-L150-Z02	17	2	16	150	25	10		38,60 €
	AEM90-BD11T3-D17-C16-L180-Z02	17	2	16	180	50	10		50,90 €
	AEM90-BD11T3-D18-W16-L100-Z02	18	2	16	100	25	10		34,50 €
	AEM90-BD11T3-D18-W16-L100-Z02-H	18	2	16	100	25	10		34,50 €
	YENİ AEM90-BD11T3-D20-W20-L81-Z03-H	20	3	20	81	30	10		41,40 €
	AEM90-BD11T3-D20-W20-L100-Z02-H	20	2	20	100	30	10		34,50 €
	AEM90-BD11T3-D20-W20-L100-Z03-H	20	3	20	100	30	10		41,40 €
	AEM90-BD11T3-D20-C20-L110-Z03-H	20	3	20	110	30	10		41,40 €
	AEM90-BD11T3-D20-W20-L150-Z02	20	2	20	150	50	10	BDMT 11T3..	34,50 €
	AEM90-BD11T3-D20-W20-L150-Z03	20	3	20	150	50	10	KYCR UCUNA	41,40 €
	YENİ AEM90-BD11T3-D20-C20-L170-Z03-H	20	3	20	170	50	10	UYGUNDUR.	56,30 €
	AEM90-BD11T3-D21-W20-L150-Z03	21	3	20	150	25	10		44,20 €
	YENİ AEM90-BD11T3-D20-W20-L150-Z03-H	20	3	20	150	50	10		49,70 €
	AEM90-BD11T3-D21-C20-L200-Z02	21	2	20	200	25	10		63,40 €
	AEM90-BD11T3-D22-W20-L090-Z02-H	22	2	20	90	25	10		37,10 €
	AEM90-BD11T3-D25-W25-L100-Z03-H	25	3	25	100	30	10		43,10 €
	YENİ AEM90-BD11T3-D25-C20-L120-Z03-H	25	3	20	120	30	10		43,10 €
	AEM90-BD11T3-D25-C25-L120-Z03-H	25	3	25	120	30	10		43,10 €
	AEM90-BD11T3-D25-W25-L150-Z03	25	3	25	150	50	10		43,10 €
	AEM90-BD11T3-D26-W25-L150-Z03	26	3	25	150	35	10		44,20 €
	AEM90-BD11T3-D26-C25-L250-Z02	26	2	25	250	35	10		95,70 €
	AEM90-BD11T3-D32-W32-L110-Z04-H	32	4	32	110	40	10		50,20 €
	AEM90-BD11T3-D32-C32-L130-Z04-H	32	4	32	130	40	10		50,20 €
	AEM90-BD11T3-D32-W32-L150-Z04	32	4	32	150	50	10		50,20 €
	AEM90-BD11T3-D40-W32-L110-Z04-H	40	4	32	110	35	10		52,80 €
	AEM90-BD1704-D25-W25-L100-Z02-H	25	2	25	100	35	15.7		43,10 €
	AEM90-BD1704-D25-W25-L150-Z02	25	2	25	150	50	15.7		43,10 €
	YENİ AEM90-BD1704-D25-C25-L210-Z02-H	25	2	25	210	100	15.7		72,40 €
AEM90-BD1704-D32-W32-L110-Z03-H	32	3	32	110	40	15.7	BDMT 1704..	50,20 €	
YENİ AEM90-BD1704-D32-C32-L130-Z03-H	32	3	32	130	50	15.7	KYCR UCUNA	50,20 €	
YENİ AEM90-BD1704-D32-W32-L130-Z03-H	32	3	32	130	40	15.7	UYGUNDUR.	50,20 €	
AEM90-BD1704-D32-W32-L150-Z03	32	3	32	150	40	15.7		50,20 €	
AEM90-BD1704-D40-W32-L110-Z04-H	40	4	32	110	40	15.7		56,50 €	
AEM90-BD1704-D40-W32-L150-Z04	40	4	32	150	40	15.7		56,50 €	
	AEM90-ED10T3-D16-W16-L120-Z02	16	2	16	120	30	10	EDPT 10T3..	44,20 €
	AEM90-ED10T3-D20-W20-L120-Z02	20	2	20	120	30	10	KNMTL UCUNA UYGUNDUR.	44,20 €
	AEM90-ED1404-D20-W20-L150-Z02	20	2	20	150	50	14.5	EDPT 1404..	44,20 €
	AEM90-ED1404-D25-W25-L150-Z02	25	2	25	150	50	14.5	KNMTL UCUNA	47,80 €
	AEM90-ED1404-D30-C25-L150-Z03	30	3	25	150	50	14.5	UYGUNDUR.	62,50 €

90°

90°

S SİSTEM YÜZEY PARMAK FREZELER

	TAKIM KODU	TAKIM ÖLÇÜLERİ (mm)						KESİCİ UÇ	FİYAT
		DC	ZEFP	DCON	LF	LH	APMX		
 90°	AEM90-LN08-D16-W16-L100-Z02-H	16	2	16	100	28	8		48,30 €
	YENİ AEM90-LN08-D16-W16-L150-Z02	16	2	16	150	40	8	LNMT 0804..	48,30 €
	AEM90-LN08-D20-W20-L100-Z03-H	20	3	20	100	28	8	ISCR UCUNA	58,40 €
	AEM90-LN08-D25-W25-L100-Z03-H	25	3	25	100	30	8	UYGUNDUR.	61,20 €
	AEM90-LN08-D32-W32-L110-Z05-H	32	5	32	110	30	8		71,10 €
 90°	AEM90-LN15T6-D25-W25-L150-Z02-H	25	2	25	150	50	15.5	LNGU 15T6..	47,00 €
	AEM90-LN15T6-D32-W32-L150-Z03-H	32	3	32	150	50	15.5	KNMTL UCUNA	54,10 €
	AEM90-LN15T6-D40-W32-L150-Z03-H	40	3	32	150	40	15.5	UYGUNDUR.	58,40 €
 90°	AEM90-LN1006-D16-W16-L120-Z01-H	16	1	16	120	30	9		39,40 €
	AEM90-LN1006-D16-W16-L150-Z01	16	1	16	150	50	9		39,40 €
	AEM90-LN1006-D18-W16-L120-Z02-H	18	2	16	120	30	9		42,20 €
	AEM90-LN1006-D20-W20-L120-Z02-H	20	2	20	120	30	9	LN.X 1006..	42,20 €
	AEM90-LN1006-D20-W20-L150-Z02	20	2	20	150	50	9	KRLY UCUNA	42,20 €
	AEM90-LN1006-D25-W25-L120-Z03-H	25	3	25	120	30	9	UYGUNDUR.	47,10 €
	AEM90-LN1006-D25-W25-L150-Z03	25	3	25	150	50	9		47,10 €
	AEM90-LN1006-D32-W32-L120-Z04-H	32	4	32	120	30	9		55,30 €
	AEM90-LN1006-D32-W32-L150-Z04	32	4	32	150	50	9		55,30 €
 90°	AEM90-LN1106-D25-W25-L150-Z03	25	3	25	150	40	10	LNMT 1106..	55,60 €
	AEM90-LN1106-D32-W32-L150-Z04	32	4	32	150	40	10	ISCR-XTC-GSC	64,70 €
	AEM90-LN1106-D40-W32-L150-Z05	40	5	32	150	40	10	UCUNA	73,70 €
								UYGUNDUR.	

Kesme Hesabı : S 142

Sipariş Örneği: 1 ad. AEM90-LN08-D16-W16-L100-Z02-H

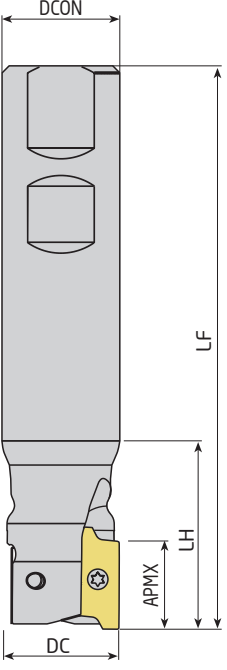

S SİSTEM YÜZEY PARMAK FREZELER

	TAKIM KODU	TAKIM ÖLÇÜLERİ (mm)						KESİCİ UÇ	FİYAT
		DC	ZFP	DCON	LF	LH	APMX		
  90°	AEM90-RT07-D10-W10-L120-Z02	10	2	10	120	30	7	RT 0702..	31,50 €
	AEM90-RT07-D12-W12-L120-Z02	12	2	12	120	30	7	SFTY UCUNA	31,50 €
	AEM90-RT07-D12-C12-L120-Z02	12	2	12	120	30	7	UYGUNDUR.	31,50 €
	AEM90-RT07-D14-W12-L120-Z02	14	2	12	120	30	7		31,50 €
	AEM90-RT10-D16-W16-L120-Z02-H	16	2	15	160	30	10		31,50 €
	AEM90-RT10-D16-W16-L150-Z02	16	2	16	120	30	10		31,50 €
	AEM90-RT10-D16-C15-L160-Z02	16	2	16	150	50	10		36,40 €
	AEM90-RT10-D16-C16-L200-Z02	16	2	16	200	100	10		47,80 €
	AEM90-RT10-D17-W16-L160-Z02	17	2	16	160	30	10		36,40 €
	AEM90-RT10-D17-C16-L200-Z02	17	2	16	200	30	10		47,80 €
	AEM90-RT10-D18-W16-L120-Z02-H	18	2	16	120	30	10		31,50 €
	AEM90-RT10-D20-W20-L120-Z03-H	20	3	19	200	30	10		40,10 €
	AEM90-RT10-D20-W20-L150-Z03	20	3	20	120	30	10		40,10 €
	AEM90-RT10-D20-C19-L200-Z03	20	3	20	150	50	10		57,30 €
	AEM90-RT10-D20-C20-L110-Z03	20	3	20	110	30	10	RT 1003..	40,10 €
	AEM90-RT10-D20-C20-L200-Z03	20	3	20	200	100	10	SFTY UCUNA	55,80 €
	AEM90-RT10-D21-W20-L200-Z03	21	3	20	200	30	10	UYGUNDUR.	59,70 €
	AEM90-RT10-D22-W20-L120-Z03-H	22	3	20	120	30	10		40,10 €
	AEM90-RT10-D22-C20-L150-Z03	22	3	20	150	30	10		40,10 €
	AEM90-RT10-D22-C20-L200-Z03	22	3	20	200	30	10		59,70 €
	AEM90-RT10-D25-W25-L120-Z04-H	25	4	25	120	40	10		44,20 €
	AEM90-RT10-D25-W25-L150-Z04	25	4	25	150	50	10		44,20 €
	AEM90-RT10-D25-C25-L200-Z04	25	4	25	200	100	10		59,70 €
	AEM90-RT10-D26-C25-L250-Z04	26	4	25	250	32	10		64,20 €
	AEM90-RT10-D32-W32-L120-Z05-H	32	5	32	120	50	10		47,80 €
	AEM90-RT10-D32-W32-L150-Z05	32	5	32	150	50	10		47,80 €
	AEM90-RT10-D32-C32-L200-Z05	32	5	32	200	100	10		63,60 €
	AEM90-RT10-D33-C32-L250-Z04	33	4	32	250	32	10		81,30 €
	AEM90-RT13-D32-C32-L250-Z04	32	4	32	250	50	13	RT 1304..	79,30 €
	AEM90-RT16-D25-W25-L120-Z02-H	25	2	25	120	40	16		40,10 €
	AEM90-RT16-D25-W25-L150-Z02	25	2	25	150	50	16		40,10 €
	AEM90-RT16-D25-C25-L200-Z02	25	2	25	200	100	16		55,80 €
	AEM90-RT16-D32-W32-L120-Z03-H	32	3	32	120	50	16		44,20 €
	AEM90-RT16-D32-W32-L150-Z03	32	3	32	150	50	16	RT 1606..	44,20 €
	AEM90-RT16-D32-C32-L200-Z03	32	3	32	200	100	16	SFTY UCUNA	59,70 €
	AEM90-RT16-D32-C32-L250-Z03	32	3	32	250	100	16	UYGUNDUR.	71,60 €
	AEM90-RT16-D32-C32-L270-Z03	32	3	32	270	100	16		75,90 €
	AEM90-RT16-D40-W32-L120-Z04-H	40	4	32	120	50	16		47,80 €
	AEM90-RT16-D40-W32-L150-Z04	40	4	32	150	50	16		47,80 €
	AEM90-RT16-D40-C32-L200-Z04	40	4	32	200	100	16		63,60 €

S SİSTEM YÜZEY PARMAK FREZELER

96/97

	TAKIM KODU	TAKIM ÖLÇÜLERİ (mm)						KESİCİ UÇ	FİYAT
		DC	ZEFP	DCON	LF	LH	APMX		
	AEM90-SO0803-D20-C16-L110-Z02-H	20	2	16	110	25	7	SOMT 0803..	41,40 €
	AEM90-SO0803-D25-C20-L110-Z02-H	25	2	20	110	25	7	SMTM UCUNA	45,00 €
	AEM90-SO0803-D32-C25-L120-Z03-H	32	3	25	120	30	7	UYGUNDUR.	55,20 €
	AEM90-SPGT0602-D16-W16-L150-Z02	16	2	16	150	50	5.5	SPGT 0602..	44,80 €
	AEM90-SPGT07T3-D20-W20-L150-Z03	20	3	20	150	50	7	SPGT 07T3..	50,20 €
	AEM90-SPGT07T3-D25-W25-L150-Z03	25	3	25	150	50	7	ZCC UCUNA UYGUNDUR.	53,40 €
	AEM90-SPGT0904-D30-W32-L150-Z03	30	3	32	150	50	9	SPGT 0904..	55,20 €
	AEM90-TNG10-D20-C20-L125-Z02-H	20	2	20	125	29	5		53,90 €
	AEM90-TNG10-D20-C20-L125-Z03-H	20	3	20	125	29	5		63,90 €
	AEM90-TNG10-D20-C20-L150-Z03-H	20	3	20	150	50	5	TNGX 1004..	76,70 €
	AEM90-TNG10-D21-C20-L200-Z03-H	21	3	20	200	30	5	PRMT UCUNA	100,00 €
	AEM90-TNG10-D25-C25-L150-Z03-H	25	3	25	150	34	5	UYGUNDUR.	76,70 €
	AEM90-TNG10-D25-C25-L150-Z04-H	25	4	25	150	34	5		86,70 €
	AEM90-TNG10-D25-C25-L170-Z04-H	25	4	25	170	50	5		98,30 €
	AEM90-TNG10-D26-C25-L250-Z04-H	26	4	25	250	35	5		140,00 €
	AEM90-TNG10-D32-C32-L170-Z04-H	32	4	32	170	37	5		108,10 €
	AEM90-TNG10-D32-C32-L170-Z05-H	32	5	32	170	37	5		118,10 €
	AEM90-VC2205-D32-C25-L150-Z02-H	32	2	25	150	50	15	VCKT 2205..	52,90 €
	AEM90-VC2205-D40-C32-L150-Z03-H	40	3	32	150	50	15	KRLY UCUNA	60,30 €
	AEM90-WNG04-D20-W20-L81-Z03-H	20	3	20	81	31	4		45,20 €
	AEM90-WNG04-D20-C20-L170-Z03-H	20	3	20	170	50	4		56,60 €
	AEM90-WNG04-D25-W25-L88-Z03-H	25	3	25	88	32	4		45,20 €
	AEM90-WNG04-D25-W25-L88-Z04-H	25	4	25	88	32	4	WNGU 0403..	48,20 €
	AEM90-WNG04-D25-C25-L170-Z03-H	25	3	25	170	50	4	XTC-GSC UCUNA	67,70 €
	AEM90-WNG04-D32-W25-L100-Z05-H	32	5	25	100	35	4	UYGUNDUR.	45,90 €
	AEM90-WNG04-D32-W32-L100-Z05-H	32	5	32	100	40	4		45,90 €
	AEM90-WNG04-D32-C25-L170-Z04-H	32	4	25	170	35	4		72,20 €
	AEM90-WNG04-D32-C32-L170-Z04-H	32	4	32	170	50	4		72,20 €
	AEM90-WNG08-D40-W32-L100-Z03-H	40	3	32	100	35	7.5	WNGU 0806..	88,00 €
	AEM90-WNG08-D40-C32-L170-Z03-H	40	3	32	170	35	7.5	XTC-GSC UCUNA UYGUNDUR.	59,90 €

S SİSTEM YÜZEY PARMAK FREZELER



	TAKIM KODU	TAKIM ÖLÇÜLERİ (mm)						KESİCİ UÇ	FİYAT
		DC	ZEP	DCON	LF	LH	APMX		
 90°	YENİ AEM90L-WN0604Z-D25-C25-L200-Z02-H	25	2	25	200	100	5.7	WNHU 0604..	70,30 €
	AEM90-WN0604Z-D25-W25-L150-Z02-H	25	2	25	150	50	5.7	ZCC UCUNA	52,70 €
	AEM90-WN0604Z-D32-W32-L150-Z03-H	32	3	32	150	50	5.7	UYGUNDUR.	58,00 €
	AEM90-WN0604Z-D40-W32-L150-Z04-H	40	4	32	150	35	5.7		65,90 €
 90°	AEM90-XC13-D20-W20-L150-Z02	20	2	20	150	60	13	XCKX 13T3..	37,70 €
	AEM90-XC13-D25-W25-L150-Z03	25	3	25	150	60	13	SC UCUNA	40,10 €
	AEM90-XC13-D32-W32-L150-Z04	32	4	32	150	60	13	UYGUNDUR.	45,70 €
 90°	AEM90-XD11T3-D16-W16-L150-Z02	16	2	16	150	40	10		36,40 €
	AEM90-XD11T3-D17-C16-L150-Z02	17	2	16	150	30	10		36,40 €
	AEM90-XD11T3-D20-W20-L150-Z03	20	3	20	150	50	10	XD.T 11T3..	41,60 €
	AEM90-XD11T3-D21-C20-L080-Z03-H	21	3	20	80	25	10	CRTZT UCUNA	41,60 €
	AEM90-XD11T3-D21-C20-L150-Z03	21	3	20	150	30	10	UYGUNDUR.	41,60 €
	AEM90-XD11T3-D25-W25-L150-Z04	25	4	25	150	50	10		47,80 €
	YENİ AEM90-XD11T3-D30-W25-L120-Z04	30	4	25	120	30	10		49,40 €
	AEM90-XD11T3-D32-W32-L150-Z04	32	4	32	150	50	10		49,40 €
 90°	AEM90-XN0403-D16-C16-L100-Z01-H	16	1	16	100	30	4	XNEX 0403..	39,60 €
	AEM90-XN0403-D22-C20-L110-Z03-H	22	3	20	110	30	4	SC UCUNA UYGUNDUR.	45,60 €
	AEM90-XN0806-D32-C32-L110-Z02-H	32	2	32	110	40	7.5	XNEX 0806..	50,40 €
 90°	AEM90-XO06-D10-C12-L120-Z02	10	2	12	120	50	5	XO.. 0602..	42,70 €
	AEM90-XO06-D12-C12-L120-Z02	12	2	12	120	25	5	SC UCUNA UYGUNDUR.	42,70 €
	AEM90-XO09-D16-W16-L150-Z02	16	2	16	150	50	8	XO.. 0903..	40,10 €
	AEM90-XO09-D20-W20-L150-Z03	20	3	20	150	50	8	SC UCUNA UYGUNDUR.	45,50 €
	AEM90-XO12-D20-W20-L150-Z02	20	2	20	150	50	11		36,40 €
	AEM90-XO12-D20-C20-L200-Z02	20	2	20	200	100	11		55,80 €
	AEM90-XO12-D22-W20-L150-Z02	22	2	20	150	20	11	XO.. 1204..	36,40 €
	AEM90-XO12-D25-W25-L150-Z03	25	3	25	150	50	11	SC UCUNA	40,10 €
	AEM90-XO12-D25-C25-L200-Z03	25	3	25	200	100	11	UYGUNDUR.	61,90 €
	AEM90-XO12-D32-C25-L150-Z04	32	4	25	150	40	11		45,70 €
	AEM90-XO12-D32-W32-L150-Z04	32	4	32	150	50	11		45,70 €
	AEM90-XO12-D32-C32-L250-Z04	32	4	32	250	100	11		108,60 €

S SİSTEM YÜZEY PARMAK FREZELER

98/99

	TAKIM KODU	TAKIM ÖLÇÜLERİ (mm)						KESİCİ UÇ	FİYAT
		DC	ZEPF	DCON	LF	LH	APMX		
	AEM90-ZC1003-D16-C14-L150-Z02	16	2	14	150	25	9		31,50 €
	AEM90-ZC1003-D16-C14-L200-Z02	16	2	14	200	25	9		47,80 €
	AEM90-ZC1003-D16-C15-L150-Z02	16	2	15	150	25	9		31,50 €
	AEM90-ZC1003-D16-C16-L150-Z02	16	2	16	150	25	9		31,50 €
	YENİ AEM90-ZC1003-D16-C16-L200-Z02	16	2	16	200	50	9		47,80 €
	AEM90-ZC1003-D17-C16-L150-Z02	17	2	16	150	25	9		31,50 €
	AEM90-ZC1003-D17-C16-L200-Z02	17	2	16	200	25	9		47,80 €
	AEM90-ZC1003-D20-C18-L150-Z03	20	3	18	150	25	9	ZCMT 100308R	37,70 €
	AEM90-ZC1003-D20-C18-L200-Z02	20	2	18	200	25	9	DJT UCUNA	52,80 €
	AEM90-ZC1003-D20-C20-L150-Z03	20	3	20	150	40	9	UYGUNDUR.	37,70 €
	AEM90-ZC1003-D20-C18-L200-Z03	20	3	18	200	25	9		56,90 €
	AEM90-ZC1003-D21-C20-L150-Z02	21	2	20	150	30	9		31,50 €
	AEM90-ZC1003-D21-C20-L150-Z03	21	3	20	150	30	9		37,70 €
	AEM90-ZC1003-D21-C20-L200-Z03	21	3	20	200	30	9		58,00 €
	AEM90-ZC1003-D25-C20-L150-Z03	25	3	20	150	30	9		37,70 €
	AEM90-ZC1003-D25-C20-L200-Z03	25	3	20	200	30	9		56,90 €
	AEM90-ZC1003-D25-C25-L150-Z03	25	3	25	150	40	9		37,70 €
	AEM90-ZC1003-D26-C25-L170-Z03	26	3	25	170	25	9		41,60 €
AEM90-ZC1003-D26-C25-L200-Z03	26	3	25	200	25	9		56,90 €	
AEM90-ZC1003-D32-C25-L180-Z04	32	4	25	180	30	9		60,30 €	
AEM90-ZC1003-D33-C32-L200-Z04	33	4	32	200	25	9		62,50 €	
	AEM90-ZP13T3-D26-C25-L200-Z02	26	2	25	200	35	13		52,80 €
	AEM90-ZP13T3-D26-C25-L200-Z03	26	3	25	200	35	13	ZPMT 13T3..	56,90 €
	AEM90-ZP13T3-D26-C25-L250-Z02	26	2	25	250	35	13	DJT UCUNA	73,90 €
	AEM90-ZP13T3-D33-C32-L200-Z03	33	3	32	200	40	13	UYGUNDUR.	62,50 €
	AEM90-ZP13T3-D33-C32-L250-Z03	33	3	32	250	40	13		82,50 €
	YENİ AEM90-3P0603-D16-W16-L120-Z03-H	16	3	16	120	25	4,7	3P.T 0603	56,90 €
	YENİ AEM90-3P0603-D20-W20-L150-Z03-H	20	3	20	150	25	4,7	TGTC UCUNA	62,00 €
	YENİ AEM90-3P0603-D25-W25-L150-Z05-H	25	5	25	150	25	4,7	UYGUNDUR.	77,00 €
	AEM90-3P1004-D20-W20-L150-Z02	20	2	20	150	40	7	3P.T 1004	44,80 €
	YENİ AEM90-3P1004-D21-C20-L200-Z02	21	2	20	200	30	7	TGTC UCUNA	67,20 €
	AEM90-3P1004-D25-W25-L150-Z03	25	3	25	150	40	7	UYGUNDUR.	51,70 €
	AEM90-3P1505-D32-W32-L150-Z03	32	3	32	150	50	11	3P.T 1505	53,40 €
	YENİ AEM90-3P1505-D38-W32-L150-Z03	38	3	32	150	35	11	TGTC UCUNA	58,70 €
	AEM90-3P1505-D40-W32-L150-Z04	40	4	32	150	35	11	UYGUNDUR.	60,30 €
	AEM90-4N06-D16-W16-L120-Z02-H	16	2	16	120	25	6	4NKT 0603..	45,50 €
	AEM90-4N06-D16-W16-L160-Z02	16	2	16	160	25	6	TGTC UCUNA	45,50 €
	AEM90-4N06-D20-W16-L120-Z03-H	20	3	16	120	20	6	UYGUNDUR.	59,70 €
	AEM90-4N06-D20-W16-L160-Z03	20	3	16	160	20	6		59,70 €

S SİSTEM YÜZEY ve KOPYA PARMAK FREZELER

	TAKIM KODU	TAKIM ÖLÇÜLERİ (mm)					KESİCİ UÇ	FİYAT
		DCX	ZEFP	DCON	LF	LH		
	AEMR-RP08T2M-D20-W20-L150-Z02-H	20	2	20	150	60	RPMT 08T2..	53,00 €
	AEMR-RP08T2M-D25-W25-L200-Z03-H	25	3	25	200	100	MTSBSH UCUNA UYGUNDUR.	81,60 €
	AEMR-RP10T3M-D25-W25-L200-Z02-H	25	2	25	200	100	RPMT 10T3..	71,60 €
	AEMR-RP10T3M-D32-W32-L200-Z03-H	32	3	32	200	100	MTSBSH UCUNA UYGUNDUR.	88,80 €
	AEMR-RP1204M-D32-W32-L150-Z03-H	32	3	32	150	60	RPMT 1204..	59,20 €
	AEMR-RP1204M-D32-W32-L200-Z03-H	32	3	32	200	100	MTSBSH UCUNA UYGUNDUR.	88,80 €
	AEMR-RP1606M-D40-W32-L150-Z02-H	40	2	16	150	35	RPMT 1606..	68,50 €
	AEMR-RP1606M-D40-W32-L200-Z02-H	40	2	16	200	35	MTSBSH UCUNA UYGUNDUR.	102,80 €
	AEMR-RY08-D16-W16-L150-Z02	16	16	2	150	55	RYMX 0803..	40,70 €
	AEMR-RY10-D20-W20-L150-Z02	20	20	2	150	60		44,10 €
	AEMR-RY10-D20-C20-L200-Z02	20	20	2	200	100	RYMX 1004..	59,50 €
	AEMR-RY10-D21-W20-L200-Z02-H	21	20	2	200	30	TGTC UCUNA	71,40 €
	AEMR-RY10-D25-W25-L150-Z02	25	25	2	150	60	UYGUNDUR.	47,80 €
	AEMR-RY10-D26-W25-L200-Z02-H	26	25	2	200	60		86,00 €
	AEMR-RY10-D32-W32-L160-Z04-H	32	32	4	160	60		76,60 €
	AEMR-RY12-D32-C25-L160-Z03	32	25	3	160	30	RYMX 1205..	59,30 €
	AEMR-QP10T3-D20-C20-L150-Z01-H	20	1	20	150	70		52,20 €
	AEMR-QP10T3-D25-C25-L120-Z02-H	25	2	25	120	40		61,20 €
	AEMR-QP10T3-D25-C25-L150-Z02-H	25	2	25	150	70	QP.. 10T3..	61,20 €
	AEMR-QP10T3-D25-C25-L170-Z02	25	2	25	170	90	SMTM UCUNA	57,10 €
	AEMR-QP10T3-D32-C32-L150-Z03-H	32	3	32	150	70	UYGUNDUR.	69,40 €
	AEMR-QP10T3-D32-C32-L170-Z03	32	3	32	170	90		61,90 €
	AEMR-QP1204-D25-C25-L150-Z02-H	25	2	25	150	70	QP.. 1204.. SMTM	61,20 €

Kesme Hesabı : S 142

Sipariş Örneği: 1 ad. AEMR-RP10T3M-D32-W32-L200-Z03-H

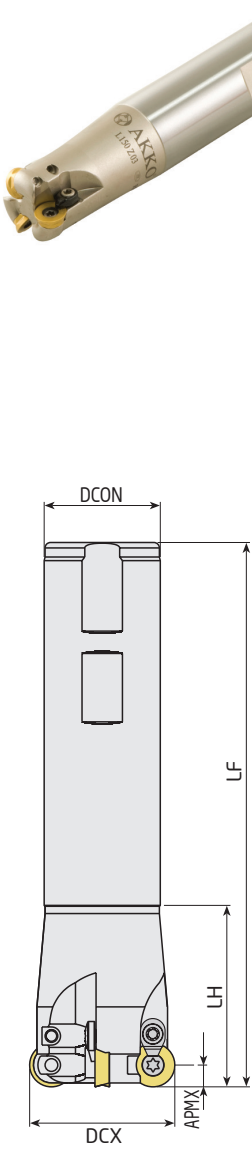

S SİSTEM YÜZEY ve KOPYA PARMAK FREZELER

	TAKIM KODU	TAKIM ÖLÇÜLERİ (mm)					KESİCİ UÇ	FİYAT
		DCX	ZEFP	DCON	LF	LH		
	AEMR-RD0501-D08-W10-L100-Z01-H	8	1	10	100	20		36,40 €
	AEMR-RD0501-D10-W12-L100-Z02-H	10	2	12	100	20	RD.. 0501	41,40 €
	AEMR-RD0501-D12-W12-L120-Z02-H	12	2	12	120	20		41,40 €
	AEMR-RD0803-D16-W16-L150-Z02	16	2	16	150	60	RD.. 0803	36,40 €
	AEMR-RD0803-D16-C20-L200-Z02	16	2	20	200	60	ISO	55,80 €
	AEMR-RD0803-D20-W20-L150-Z03	20	3	20	150	60		54,20 €
	AEMR-RD08T2-D16-W16-L150-Z02	16	2	16	150	60	RD.. 08T2	36,40 €
	AEMR-RD08T2-D20-W20-L150-Z02	20	2	20	150	60	ISO	44,20 €
	AEMRC-RD1003-D20-W20-L150-Z02	20	2	20	150	60		44,20 €
	AEMRC-RD1003-D20-C20-L160-Z02	20	2	20	160	70		47,80 €
	AEMRC-RD1003-D20-C20-L250-Z02	20	2	20	250	150		79,30 €
	AEMRC-RD1003-D21-C20-L160-Z02	21	2	20	160	70		47,80 €
	AEMRC-RD1003-D25-W25-L150-Z02	25	2	25	150	60		44,20 €
	AEMRC-RD1003-D25-C25-L160-Z02	25	2	25	160	70		47,80 €
	AEMRC-RD1003-D25-W25-L200-Z02	25	2	25	200	100		59,70 €
	AEMRC-RD1003-D25-C25-L200-Z02	25	2	25	200	100	RD.. 1003	59,70 €
	AEMRC-RD1003-D25-C25-L250-Z02	25	2	25	250	150	ISO	79,30 €
	AEMRC-RD1003-D26-C25-L160-Z02	26	2	25	160	70		47,80 €
	AEMRC-RD1003-D32-W32-L150-Z03	32	3	32	150	60		49,40 €
	AEMRC-RD1003-D32-C32-L250-Z02	32	2	32	250	150		83,60 €
	AEMRC-RD1003-D33-C32-L160-Z03	33	3	32	160	70		53,90 €
	AEMRC-RD1003-D40-W32-L150-Z04	40	4	32	150	35		55,80 €
	AEMRC-RD1003-D40-C32-L250-Z02	40	2	32	250	50		87,50 €
	YENİ AEMRC-RD10T3-D20-C20-L150-Z02	20	2	20	150	60		44,20 €
	AEMRC-RD10T3-D20-W20-L150-Z02	20	2	20	150	60		44,20 €
	YENİ AEMRC-RD10T3-D25-C25-L150-Z02	25	2	25	150	60	RD.. 10T3	44,20 €
	YENİ AEMRC-RD10T3-D25-C25-L200-Z02-H	25	2	25	150	60	ISO	44,20 €
	AEMRC-RD10T3-D25-W25-L150-Z02	32	3	32	150	60		71,60 €
	YENİ AEMRC-RD10T3-D32-C25-L250-Z03-H	25	2	25	150	60		101,20 €
	AEMRC-RD10T3-D32-W32-L150-Z03	25	2	25	200	100		49,40 €
	AEMRC-RD12T3-D25-W25-L150-Z02	25	2	25	250	150		53,90 €
	AEMRC-RD12T3-D25-W25-L200-Z02	25	2	25	200	100	RD.. 12T3	53,90 €
	AEMRC-RD12T3-D25-C25-L250-Z02	25	2	25	300	200	ISO	53,90 €
	AEMRC-RD12T3-D25-C25-L300-Z02	32	3	32	150	60		44,20 €
	AEMRC-RD12T3-D32-W32-L150-Z03	32	2	32	250	150		59,70 €
	AEMRC-RD12T3-D32-C32-L250-Z02	32	3	25	250	35		79,30 €
	AEMRC-RD12T3-D40-W32-L150-Z04	40	4	32	150	50		107,10 €
	AEMRC-RD12T3-D40-C32-L250-Z02	40	2	32	250	50		49,40 €
	AEMRC-RD1204-D32-C32-L160-Z03	32	3	32	160	70		83,60 €
	AEMRC-RD1204-D32-W32-L160-Z03	32	3	32	160	50	RD.. 12T3	55,80 €
AEMRC-RD1204-D33-C32-L160-Z03	33	3	32	160	70	ISO	87,50 €	
AEMRC-RD1604-D40-W32-L150-Z02	40	2	32	150	35	RD.. 1604	51,90 €	

S SİSTEM YÜZEY ve KOPYA PARMAK FREZELER

	TAKIM KODU	TAKIM ÖLÇÜLERİ (mm)					KESİCİ UÇ	FİYAT
		DCX	ZEFP	DCON	LF	LH		
	YENİ AEMR-RP10T3-D25-W25-L125-Z02	25	2	25	125	60	RPNX 10T3..	45,50 €
	AEMR-RP10T3-D25-W25-L150-Z02	25	2	25	150	60	CRTZT UCUNA	45,50 €
	AEMR-RP10T3-D32-W32-L150-Z03	32	3	32	150	60	UYGUNDUR.	51,30 €

S SİSTEM HIZLI İLERLEMELİ PARMAK FREZELER

	TAKIM KODU	TAKIM ÖLÇÜLERİ (mm)					KESİCİ UÇ	FİYAT
		DCX	ZEFP	DCON	LF	LH		
	AHFM-BN10T3-D16-C16-L100-Z02-H	16	2	16	100	30		40,10 €
	AHFM-BN10T3-D16-C16-L150-Z02-H	16	2	16	150	50		48,30 €
	AHFM-BN10T3-D20-C20-L130-Z03-H	20	3	20	130	40		54,40 €
	AHFM-BN10T3-D20-C20-L130-Z04-H	20	4	20	130	40		64,40 €
	AHFM-BN10T3-D20-C20-L160-Z03-H	20	3	20	160	80		77,90 €
	AHFM-BN10T3-D25-C25-L140-Z04-H	25	4	25	140	50	BNGX 10T3..	72,50 €
	YENİ AHFM-BN10T3-D25-W25-L140-Z04-H	25	4	25	140	50	PRMT UCUNA	72,50 €
	AHFM-BN10T3-D25-C25-L140-Z05-H	25	5	25	140	50	UYGUNDUR.	82,70 €
	AHFM-BN10T3-D25-C25-L180-Z04-H	25	4	25	180	100		115,80 €
	AHFM-BN10T3-D32-C32-L150-Z05-H	32	5	32	150	70		100,90 €
	AHFM-BN10T3-D32-C32-L150-Z06-H	32	6	32	150	70		110,90 €
AHFM-BN10T3-D35-C32-L200-Z06-H	35	6	32	200	50		155,30 €	
	AHFM-BL0603-D16-C15-L150-Z02	16	2	15	150	20		40,10 €
	AHFM-BL0603-D16-C16-L100-Z02-H	16	2	16	100	30		40,10 €
	AHFM-BL0603-D16-C16-L150-Z02	16	2	16	150	50		40,10 €
	AHFM-BL0603-D17-C16-L150-Z02	17	2	16	150	20		40,10 €
	AHFM-BL0603-D17-W16-L170-Z02	17	2	16	170	20		45,50 €
	AHFM-BL0603-D17-W16-L170-Z02-H	17	2	16	170	20		56,90 €
	YENİ AHFM-BL0603-D17-C16-L200-Z02	17	2	16	200	30		60,20 €
	AHFM-BL0603-D18-C16-L150-Z02	18	2	16	150	20		40,10 €
	AHFM-BL0603-D18-W16-L150-Z02-H	18	2	16	150	20		48,30 €
	AHFM-BL0603-D20-C20-L130-Z03	20	3	20	130	50	BLMP 0603..	45,30 €
	AHFM-BL0603-D20-C20-L160-Z03	20	3	20	160	50	TGTC UCUNA	53,00 €
	AHFM-BL0603-D21-W20-L200-Z03	21	3	20	200	25	UYGUNDUR.	75,90 €
	YENİ AHFM-BL0603-D22-W20-L150-Z03	22	3	20	150	25		53,00 €
	AHFM-BL0603-D21-C20-L200-Z03	21	3	20	200	20		75,90 €
	AHFM-BL0603-D25-C25-L250-Z04	25	4	25	250	40		125,40 €
	AHFM-BL0603-D26-W25-L200-Z04	26	4	25	200	35		83,20 €
	YENİ AHFM-BL0603-D26-C25-L250-Z04	26	4	25	250	35		125,40 €
	AHFM-BL0603-D26-C25-L200-Z04	26	4	25	200	35		83,20 €
	AHFM-BL0603-D32-C32-L150-Z05	32	5	32	150	70		60,80 €
	AHFM-BL0603-D32-C32-L200-Z05	32	5	32	200	120		91,80 €
	YENİ AHFM-BL0603-D33-C32-L150-Z05	33	5	32	150	40		68,80 €
	AHFM-BL0603-D33-C32-L200-Z05	33	5	32	200	40		91,80 €
	YENİ AHFM-BL0603-D33-C32-L250-Z05	33	5	32	250	40		137,70 €

SİSTEM HIZLI İLERLEMELİ PARMAK FREZELER

102/103

	TAKIM KODU	TAKIM ÖLÇÜLERİ (mm)					KESİCİ UÇ	FİYAT
		DCX	ZEFP	DCON	LF	LH		
	AHFM-E00602-D10-C10-L080-Z02	10	2	10	80	20		39,90 €
	AHFM-E00602-D10-C09-L120-Z02	10	2	9	120	15		39,90 €
	AHFM-E00602-D10-C10-L120-Z02	10	2	10	120	60		39,90 €
	AHFM-E00602-D12-C12-L080-Z02	12	2	12	80	20	EO.. 0602..	39,90 €
	AHFM-E00602-D12-C12-L080-Z03	12	3	12	80	20	ZOMT 0602..	44,80 €
	AHFM-E00602-D12-C11-L120-Z02	12	2	11	120	15	DJT UCUNA	39,90 €
	AHFM-E00602-D12-C11-L120-Z03	12	3	11	120	15	UYGUNDUR.	44,80 €
	AHFM-E00602-D12-C12-L120-Z02	12	2	12	120	60		39,90 €
	AHFM-E00602-D12-C12-L120-Z03	12	3	12	120	60		44,80 €
	AHFM-E00602-D16-C16-L150-Z04	16	4	16	150	60		50,20 €
	AHFM-EP1003-D16-C16-L150-Z02-H	16	2	16	150	50	EP.. 1003..	31,50 €
	AHFM-EP1003-D17-C16-L150-Z02-H	17	2	16	150	20	ZPMT 1003..	31,50 €
	AHFM-EP1003-D20-C20-L150-Z04-H	20	4	20	150	50	YPHW 1003..	43,80 €
	AHFM-EP1003-D21-C20-L150-Z04-H	21	4	20	150	20	DJT UCUNA	43,80 €
	AHFM-EP1003-D25-C25-L200-Z04-H	25	4	25	200	100	UYGUNDUR.	65,70 €
	AHFM-EP1003-D25-C25-L250-Z04-H	25	4	25	250	100		98,60 €
	AHFM-EN1004-D16-C15-L150-Z02	16	2	15	150	25		34,90 €
	AHFM-EN1004-D16-C16-L150-Z02	16	2	16	150	25		34,90 €
	AHFM-EN1004-D16-C16-L200-Z02	16	2	16	200	25		52,40 €
	AHFM-EN1004-D16-C16-L250-Z02	16	2	16	250	25		78,60 €
	AHFM-EN1004-D17-C16-L150-Z02-H	17	2	16	150	25		41,80 €
	AHFM-EN1004-D17-C16-L150-Z02	17	2	16	150	25		34,90 €
	AHFM-EN1004-D17-C16-L200-Z02	17	2	16	200	25		52,40 €
	AHFM-EN1004-D18-C16-L150-Z02	18	2	16	150	25		34,90 €
	AHFM-EN1004-D20-C20-L150-Z03	20	3	20	150	40		41,60 €
	AHFM-EN1004-D20-C20-L250-Z03-H	20	3	20	250	70		93,80 €
	AHFM-EN1004-D21-C20-L150-Z02	21	2	20	150	30		37,30 €
	AHFM-EN1004-D21-C20-L150-Z03	21	3	20	150	30		41,60 €
	AHFM-EN1004-D21-C20-L150-Z03-H	21	3	20	150	30	ENMU 1004..	49,90 €
	AHFM-EN1004-D20-C20-L200-Z03	20	3	20	200	30	DJT UCUNA	62,50 €
	AHFM-EN1004-D21-C20-L200-Z03	21	3	20	200	30	UYGUNDUR.	62,50 €
	AHFM-EN1004-D22-C20-L150-Z03	22	3	20	150	30		41,60 €
	AHFM-EN1004-D25-C25-L150-Z03	25	3	25	150	40		41,60 €
	AHFM-EN1004-D25-C25-L150-Z04	25	4	25	150	40		45,90 €
	AHFM-EN1004-D26-C25-L150-Z03	26	3	25	150	30		41,60 €
	AHFM-EN1004-D26-C25-L150-Z04	26	4	25	150	30		45,90 €
	AHFM-EN1004-D26-C25-L200-Z03	26	3	25	200	30		62,50 €
	AHFM-EN1004-D26-C25-L200-Z03-H	26	3	25	200	30		75,00 €
	AHFM-EN1004-D26-C25-L250-Z03-H	26	3	25	250	30		112,50 €
	AHFM-EN1004-D28-C25-L200-Z04	28	4	25	200	30		85,30 €
	AHFM-EN1004-D32-C32-L200-Z04	32	4	32	200	30		85,30 €
	AHFM-EN1004-D33-C32-L200-Z04	33	4	32	200	50		85,30 €
	AHFM-EN1004-D33-C32-L200-Z04-H	33	4	32	200	30		102,40 €

S SİSTEM HIZLI İLERLEMELİ PARMAK FREZELER

	TAKIM KODU	TAKIM ÖLÇÜLERİ (mm)					KESİCİ UÇ	FİYAT
		DCX	ZEFP	DCON	LF	LH		
	AHFMC-JD1204-D32-C32-L150-Z02	32	2	32	150	50	JDMW 1204..	61,20 €
	AHFMC-JD1204-D32-C32-L200-Z02	32	2	32	200	50	MTSBSH UCUNA	81,30 €
	AHFMC-JD1204-D35-C32-L200-Z02	35	2	32	200	50	UYGUNDUR.	85,30 €
	AHFMC-JD1204-D35-C32-L250-Z02	35	2	32	250	50		116,60 €
	AHFM-LN0303-D16-C15-L150-Z02	16	2	15	150	30		47,10 €
	AHFM-LN0303-D16-W16-L150-Z02-H	16	2	16	150	50		56,50 €
	AHFM-LN0303-D20-W20-L150-Z03-H	20	3	20	150	50	LNMU 0303..	68,30 €
	AHFM-LN0303-D21-C20-L150-Z03	21	3	20	150	30	TNGLY UCUNA	56,90 €
	AHFM-LN0303-D25-W25-L150-Z04-H	25	4	25	150	50	UYGUNDUR.	81,50 €
	AHFM-LN0303-D26-C25-L150-Z04	26	4	25	150	30		67,90 €
	AHFM-LN0303-D33-C32-L200-Z05	33	5	32	200	30		78,90 €
	AHFM-LO03-D16-C16-L100-Z02	16	2	15	160	30		38,80 €
	AHFM-LO03-D16-C16-L100-Z02-F	16	2	16	100	30		58,20 €
	YENİ AHFM-LO03-D16-C16-L130-Z02-H	16	2	16	100	30		43,80 €
	AHFM-LO03-D16-C15-L160-Z02	16	2	16	130	40		47,10 €
	AHFM-LO03-D16-C16-L160-Z02	16	2	16	160	50		47,10 €
	YENİ AHFM-LO03-D16-C16-L160-Z02-H	16	2	16	160	100		48,60 €
	AHFM-LO03-D17-C16-L180-Z02	17	2	16	180	30		58,20 €
	AHFM-LO03-D20-C20-L130-Z03	20	3	20	130	40		49,10 €
	YENİ AHFM-LO03-D20-C20-L130-Z03-H	20	3	20	130	40	LOGU 0303..	63,60 €
	AHFM-LO03-D20-C20-L160-Z03	20	3	20	160	80	KYCR UCUNA	60,30 €
	YENİ AHFM-LO03-D20-C20-L160-Z03-H	20	3	20	160	100	UYGUNDUR.	63,60 €
	YENİ AHFM-LO03-D21-C20-L150-Z03-H	21	3	20	150	30		63,60 €
	AHFM-LO03-D21-C20-L200-Z03	21	3	20	200	30		76,30 €
	YENİ AHFM-LO03-D21-C20-L200-Z03-H	21	3	20	200	30		91,60 €
	AHFM-LO03-D25-C25-L140-Z04	25	4	25	140	50		69,80 €
	AHFM-LO03-D25-C25-L140-Z04-F	25	4	25	140	50		104,70 €
	AHFM-LO03-D25-C25-L180-Z04	25	4	25	180	100		90,50 €
	YENİ AHFM-LO03-D26-C25-L250-Z04	26	4	25	250	40		125,40 €
	AHFM-LO03-D32-C32-L200-Z05	32	5	32	200	120		113,80 €
	YENİ AHFM-LO03-D33-C32-L250-Z05	33	5	32	250	40		142,00 €
	AHFM-LP0102-D10-C09-L120-Z02	10	2	9	120	20	LPGT 0102..	42,70 €
	AHFM-LP0102-D10-C10-L120-Z02	10	2	10	120	20	KYCR UCUNA	42,70 €
	AHFM-LP0102-D12-C11-L120-Z02	12	2	11	120	20	UYGUNDUR.	42,70 €
	AHFM-LP0102-D12-C12-L120-Z02	12	2	12	120	20		42,70 €

S SİSTEM HIZLI İLERLEMELİ PARMAK FREZELER

	TAKIM KODU	TAKIM ÖLÇÜLERİ (mm)					KESİCİ UÇ	FİYAT
		DCX	ZEFP	DCON	LF	LH		
	YENİ AHFM-SD06T2-D16-C16-L100-Z02-H	16	2	16	100	50		40,00 €
	AHFM-SD06T2-D16-C16-L150-Z02-H	16	2	16	150	50		47,80 €
	YENİ AHFM-SD06T2-D16-C16-L200-Z02	16	2	16	200	100	SD.. 06T2..	60,00 €
	AHFM-SD06T2-D17-C16-L150-Z02-H	17	2	16	150	50	ZCC UCUNA	47,80 €
	AHFM-SD06T2-D20-C20-L150-Z03-H	20	3	20	150	50	UYGUNDUR.	55,00 €
	YENİ AHFM-SD06T2-D20-C20-L200-Z03	20	3	20	200	100		69,20 €
	AHFM-SD06T2-D21-C20-L150-Z03-H	21	3	20	150	50		55,00 €
	AHFM-SD06T2-D25-C25-L150-Z04-H	25	4	25	150	60		61,90 €
	AHFM-SD06T2-D26-C25-L150-Z04-H	26	4	25	150	60		61,90 €
	YENİ AHFMC-SD09T3-D22-W20-L150-Z02	22	2	20	150	30		46,60 €
	AHFMC-SD09T3-D25-C25-L150-Z02	25	2	25	150	94		46,60 €
	AHFMC-SD09T3-D25-W25-L150-Z02	25	2	25	150	94	SD.. 09T3..	46,60 €
	YENİ AHFMC-SD09T3-D28-C25-L150-Z02	28	2	25	150	30	ZCC UCUNA	47,80 €
	AHFMC-SD09T3-D32-C32-L150-Z03	32	3	32	150	100	UYGUNDUR.	53,40 €
	AHFMC-SD09T3-D32-W32-L150-Z03	32	3	32	150	90		53,40 €
	AHFM-SD09T3-D25-C25-L150-Z03	25	3	25	150	60		51,60 €
YENİ AHFMC-SD09T3-D32-C32-L150-Z04	32	4	25	150	60		58,40 €	
	AHFM-SO0803-D20-W20-L150-Z02	20	2	20	150	50	SOMW 080315	42,70 €
	AHFM-SO0803-D25-W25-L150-Z03	25	3	25	150	50	KPTK UCUNA	47,00 €
	AHFM-SO0803-D32-W32-L150-Z04	32	4	32	150	50	UYGUNDUR.	51,30 €
	AHFM-SP1004-D25-C25-L150-Z02	25	2	25	150	50	SPNW 1004..	51,10 €
	AHFM-SP1004-D32-C32-L150-Z03	32	3	32	150	50	DJT UCUNA	58,80 €
							UYGUNDUR.	
	AHFM-YO0602-D10-C09-L120-Z02-F	10	2	9	120	15		64,10 €
	AHFM-YO0602-D10-C10-L080-Z02-F	10	2	10	80	20		64,10 €
	AHFM-YO0602-D10-C10-L120-Z02-F	10	2	10	120	60		64,10 €
	AHFM-YO0602-D10-C10-L120-Z02-H-F	10	2	10	120	60		64,10 €
	AHFM-YO0602-D10-C10-L120-Z02-H	10	2	10	120	60		42,70 €
	AHFM-YO0602-D12-C11-L120-Z02-F	12	2	11	120	15		64,10 €
	AHFM-YO0602-D12-C11-L120-Z02-H-F	12	2	11	120	15	YOHW 0602..	64,10 €
	AHFM-YO0602-D12-C11-L120-Z02-H	12	2	11	120	15	DJT UCUNA	42,70 €
	AHFM-YO0602-D12-C11-L120-Z03-F	12	3	11	120	15	UYGUNDUR.	72,70 €
	AHFM-YO0602-D12-C12-L080-Z02-F	12	2	12	80	20		64,10 €
	AHFM-YO0602-D12-C12-L080-Z03-F	12	3	12	80	20		72,70 €
	AHFM-YO0602-D12-C12-L120-Z02-F	12	2	12	120	60		64,10 €
	YENİ AHFM-YO0602-D12-C12-L120-Z02-H	12	2	12	120	60		42,70 €
	AHFM-YO0602-D12-C12-L120-Z03-F	12	3	12	120	60		72,70 €
	YENİ AHFM-YO0602-D12-C12-L120-Z03-H	12	3	12	120	60		48,50 €

S SİSTEM HIZLI İLERLEMELİ PARMAK FREZELER

	TAKIM KODU	TAKIM ÖLÇÜLERİ (mm)					KESİCİ UÇ	FİYAT
		DCX	ZEFP	DCON	LF	LH		
	AHFM-YP1003-D16-C15-L150-Z02-F	16	2	15	150	20		53,20 €
	AHFM-YP1003-D16-C15-L200-Z02-F	16	2	15	200	20		79,80 €
	AHFM-YP1003-D16-C16-L150-Z02-F	16	2	16	150	50		53,20 €
	AHFM-YP1003-D17-C16-L150-Z02-F	17	2	16	150	20		53,20 €
	AHFM-YP1003-D17-C16-L200-Z02-F	17	2	16	200	20		79,80 €
	AHFM-YP1003-D20-C18-L150-Z03-F	20	3	18	150	25		64,30 €
	AHFM-YP1003-D20-C18-L200-Z03-F	20	3	18	200	25		96,50 €
	AHFM-YP1003-D20-C20-L150-Z03-F	20	3	20	150	50		64,30 €
	AHFM-YP1003-D21-C20-L150-Z03-F	21	3	20	150	20	YPHW 1003..	64,30 €
	AHFM-YP1003-D21-C20-L150-Z03-H	21	3	20	150	20	DJT UCUNA	51,40 €
	AHFM-YP1003-D21-C20-L150-Z04-F	21	4	20	150	20	UYGUNDUR.	75,70 €
	AHFM-YP1003-D21-C20-L200-Z03	21	3	20	200	20		64,30 €
	AHFM-YP1003-D21-C20-L200-Z03-F	21	3	20	200	20		96,50 €
	AHFM-YP1003-D25-C20-L150-Z04-F	25	4	20	150	25		68,80 €
	AHFM-YP1003-D25-C20-L200-Z04-F	25	4	20	200	25		103,20 €
	AHFM-YP1003-D25-C25-L150-Z04-F	25	4	25	150	50		68,80 €
	AHFM-YP1003-D26-C25-L150-Z04	26	4	25	150	30		45,90 €
	AHFM-YP1003-D26-C25-L150-Z04-F	26	4	25	150	30		68,80 €
AHFM-YP1003-D26-C25-L200-Z03-F	26	3	25	200	30		96,50 €	
AHFM-YP1003-D26-C25-L200-Z04-F	26	4	25	200	30		103,20 €	
	AHFM-WD0503D-D20-C20-L150-Z02	20	2	20	150	50	WDMT 0503..	37,70 €
	AHFM-WD0503D-D21-C20-L150-Z02	21	2	20	150	30	DJT UCUNA UYGUNDUR.	46,60 €
	AHFMC-WD06T3D-D26-C25-L200-Z02	26	2	25	200	30	WDHW 06T3..	62,10 €
	AHFMC-WD06T3D-D33-C32-L200-Z03	33	3	32	200	32	DJT UCUNA UYGUNDUR.	71,10 €
	AHFM-WD0603-D16-C16-L150-Z02	16	2	16	150	70	WDMT 0603..	78,40 €
	AHFM-WD0603-D20-C20-L150-Z03	20	3	20	150	70	SMTM	83,20 €
	AHFMC-WD0804-D25-C25-L150-Z02	25	2	25	150	70	WDMT 0804..	59,70 €
	AHFMC-WD0804-D32-C32-L150-Z03	32	3	32	150	70	SMTM	71,10 €
	AHFMC-WD1205-D32-C32-L150-Z02	32	2	32	150	70	WDMT 1205..	62,10 €
							SMTM UCUNA UYGUNDUR.	
	AHFM-W004T2D-D16-C16-L150-Z02	16	2	16	150	20	WOMW 04T2..	39,20 €
	AHFM-W004T2D-D17-C16-L150-Z02	17	2	16	150	20	DJT UCUNA UYGUNDUR.	40,50 €

S SİSTEM HIZLI İLERLEMELİ PARMAK FREZELER

106/107



	TAKIM KODU	TAKIM ÖLÇÜLERİ (mm)					KESİCİ UÇ	FİYAT
		DCX	ZEFP	DCON	LF	LH		
	AHFM-WN0603-D16-C16-L110-Z02-H	16	2	16	110	30		39,00 €
	AHFM-WN0603-D16-C16-L150-Z02-H	16	2	16	150	70	WNMX 0603..	48,90 €
	AHFM-WN0603-D17-C16-L150-Z02-H	17	2	16	150	20	KRLY UCUNA	48,90 €
	AHFM-WN0603-D20-C20-L150-Z02-H	20	2	20	150	70	UYGUNDUR.	50,60 €
	AHFM-WN0603-D20-C20-L200-Z02-H	20	2	20	200	100		70,90 €
	AHFM-WN0603-D21-C20-L150-Z02-H	21	2	20	150	20		50,60 €
	AHFM-WN09T3-D25-W25-L120-Z02-H	25	2	25	120	40		51,70 €
	AHFML-WN09T3-D25-W25-L120-Z02-H	25	2	25	120	40		51,70 €
	AHFM-WN09T3-D25-C25-L200-Z02	25	2	25	200	120		75,90 €
	AHFM-WN09T3-D30-W25-L120-Z03-H	30	3	25	120	30	WNMX 09T3..	58,60 €
	AHFM-WN09T3-D32-W32-L120-Z03-H	32	3	32	120	30	KRLY UCUNA	58,60 €
	AHFM-WN09T3-D32-W32-L200-Z03-H	32	3	32	200	100	UYGUNDUR.	97,70 €
	AHFM-WN09T3-D35-W32-L200-Z04-H	35	4	32	200	50		107,60 €
	AHFM-WN09T3-D40-W32-L120-Z04-H	40	4	32	120	30		65,50 €
	AHFM-WN09T3-D40-C32-L200-Z04	40	4	32	200	30		86,20 €
	AHFM-WN1305-D32-C32-L150-Z02-H	32	2	32	150	70	WNMX 1305..	58,60 €
	AHFM-WN1305-D32-C32-L200-Z02-H	32	2	32	200	120	KRLY UCUNA	97,70 €
	AHFM-WN1305-D40-C32-L200-Z03-H	40	3	32	200	30	UYGUNDUR.	117,60 €

Kesme Hesabı : S 142

Sipariş Örneği: 1 ad. AHFM-WN0603-D16-C16-L110-Z02-H

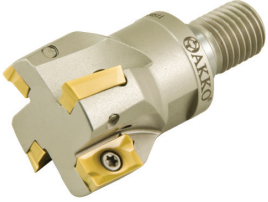
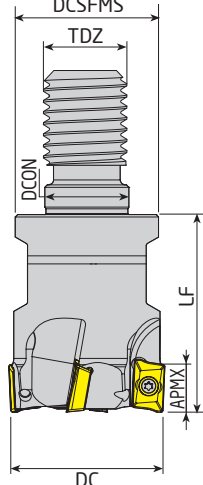

S SİSTEM MODÜLER PARMAK FREZELER



	TAKIM KODU	TAKIM ÖLÇÜLERİ (mm)						KESİCİ UÇ	FİYAT
		DC	ZEFP	DCSFMS	TDZ	LF	DCON		
  90°	YENİ AEM90-AP0903-D20-M12-L35-Z03	20	3	18	M12	35	12.5	APMT 0903..	45,70 €
	YENİ AEM90-AP0903-D25-M12-L35-Z03	25	3	21	M12	35	12.5	KRRLY UCUNA UYGUNDUR.	47,80 €
	AEM90-AP10-D16-M08-L30-Z02-H	16	2	14.75	M08	30	8.5		40,10 €
	AEM90-AP10-D20-M10-L30-Z03-H	20	3	18	M10	30	10.5		45,70 €
	AEM90-AP10-D25-M12-L35-Z03-H	25	3	21	M12	35	12.5	AP.. 1003..	47,80 €
	AEM90-AP10-D32-M16-L35-Z04-H	32	4	29	M16	35	17	ISO UCUNA	51,90 €
	YENİ AEM90-AP10-D32-M16-L40-Z04-H	32	4	29	M16	40	17	UYGUNDUR.	51,90 €
	AEM90-AP10-D40-M16-L43-Z05-H	40	5	29	M16	43	17		57,30 €
	AEM90-AP10-D42-M16-L43-Z05-H	42	5	29	M16	43	17		57,30 €
	AEM90-AP10D-D16-M08-L30-Z02-H	16	2	14.75	M08	30	8.5		40,10 €
	AEM90-AP10D-D20-M10-L30-Z03-H	20	3	18	M10	30	10.5	AP.. 1003..	45,70 €
	AEM90-AP10D-D25-M12-L35-Z03-H	25	3	21	M12	35	12.5	DJT UCUNA UYGUNDUR.	47,80 €
	AEM90-AP11-D16-M08-L30-Z02-H	16	2	14.75	M08	30	8.5		40,10 €
	AEM90-AP11-D20-M10-L30-Z03-H	20	3	18	M10	30	10.5	AP.. 11T3..	45,70 €
	AEM90-AP11-D25-M12-L35-Z03-H	25	3	21	M12	35	12.5	ZCC UCUNA	47,80 €
	AEM90-AP11-D32-M16-L35-Z04-H	32	4	29	M16	35	17	UYGUNDUR.	51,90 €
	AEM90-AP11-D40-M16-L43-Z05-H	40	5	29	M16	43	17		59,70 €
	AEM90-AP16-D25-M12-L43-Z02-H	42	4	29	M16	43	17		47,80 €
	AEM90-AP16-D32-M16-L43-Z03-H	25	2	21	M12	43	12.5	AP.. 1604..	57,30 €
	AEM90-AP16-D40-M16-L43-Z04-H	32	3	29	M16	43	17	ISO UCUNA	57,30 €
AEM90-AP16-D42-M16-L43-Z04	40	4	29	M16	43	17	UYGUNDUR.	57,30 €	
YENİ AEM90-AP16-D42-M16-L43-Z04-H	42	4	29	M16	43	17		57,30 €	
YENİ AEM90-AP16D-D25-M12-L43-Z02-H	25	2	21	M12	43	12.5		47,80 €	
AEM90-AP16D-D32-M16-L43-Z03-H	32	3	29	M16	43	17	AP.. 1604..	51,90 €	
AEM90-AP16D-D40-M16-L43-Z04-H	40	4	29	M16	43	17	DJT UCUNA	57,30 €	
AEM90-AP16L-D25-M12-L43-Z02-H	25	2	21	M12	43	12.5	UYGUNDUR.	47,80 €	
AEM90-AP16L-D32-M16-L43-Z03-H	32	3	29	M16	43	17	AP.. 1604..	51,90 €	
AEM90-AP16L-D40-M16-L43-Z04-H	40	4	29	M16	43	17	LMNA UCUNA	57,30 €	
							UYGUNDUR.		
 90°	AEM90-A01236-D16-M08-L30-Z02	16	2	14.8	M08	30	8.5	AO.. 1236..	50,00 €
	AEM90-A01236-D20-M10-L35-Z03	20	3	18	M10	35	10.5	MTSBH UCUNA	58,40 €
								UYGUNDUR.	
 90°	AEM90-AD1505D-D25-M12-L43-Z02-H	25	2	21	M12	43	12.5	ADKT 150508	52,80 €
	AEM90-AD1505D-D32-M16-L43-Z03-H	32	3	29	M16	43	17	DJT UCUNA	57,10 €
								UYGUNDUR.	

S SİSTEM MODÜLER PARMAK FREZELER

108/109



	TAKIM KODU	TAKIM ÖLÇÜLERİ (mm)						KESİCİ UÇ	FİYAT
		DC	ZEFP	DCSFMS	TDZ	LF	DCON		
 <p>90°</p>	AEM90-AX1235-D16-M08-L30-Z02-H	16	2	14.75	M08	30	8.5	AX.T 1235..	45,70 €
	AEM90-AX1235-D20-M10-L30-Z03-H	20	3	18	M10	30	10.5	SMTM UCUNA	52,80 €
	AEM90-AX1235-D25-M12-L35-Z04-H	25	4	21	M12	35	12.5	UYGUNDUR.	61,90 €
	AEM90-AX1705-D25-M12-L43-Z02-H	25	2	21	M12	43	12.5	AX.T 1705..	55,20 €
	AEM90-AX1705-D32-M16-L43-Z02-H	32	2	29	M16	43	17	SMTM UCUNA	59,70 €
							UYGUNDUR.		
 <p>YENİ</p> <p>90°</p>	AEM90-BD11T3-D16-M08-L25-Z02-H	16	2	14.75	M08	25	8.5	BDMT 11T3..	44,10 €
	AEM90-BD11T3-D25-M12-L35-Z04-H	25	4	21	M12	35	12.5	KYCR UCUNA	54,20 €
	AEM90-BD11T3-D32-M16-L40-Z05-H	32	5	29	M16	40	17	UYGUNDUR.	63,00 €
 <p>90°</p>	AEM90-DC07-D20-M10-L30-Z02-H	20	2	18	M10	30	10.5	DC.T 0702..	41,40 €
	AEM90-DC07-D25-M12-L35-Z03-H	25	3	21	M12	35	12.5	ISO UCUNA	47,80 €
	AEM90-DC07-D32-M16-L43-Z04-H	32	4	29	M16	43	17	UYGUNDUR.	51,90 €
	AEM90-DC07-D40-M16-L43-Z05-H	40	5	29	M16	43	17		57,30 €
	AEM90-DC11-D32-M16-L43-Z03-H-F	32	3	29	M16	43	17	DC.T 11T3..	85,30 €
	AEM90-DC11-D40-M16-L43-Z03-H-F	40	3	29	M16	43	17	ISO UCUNA	85,30 €
							UYGUNDUR.		
 <p>90°</p>	AEM90-R390.11-D16-M08-L30-Z02-H	16	2	14.75	M08	30	8.5	R390-11T3..	44,20 €
	AEM90-R390.11-D20-M10-L30-Z03-H	20	3	18	M10	30	10.5	SNDVK UCUNA	50,20 €
	AEM90-R390.11-D25-M12-L35-Z03-H	25	3	21	M12	35	12.5	UYGUNDUR.	52,80 €
	AEM90-R390.11-D32-M16-L43-Z04-H	32	4	29	M16	43	17		56,90 €
 <p>90°</p>	AEM90-RT10-D16-M08-L20-Z02-H	16	2	14.75	M08	20	8.5	RT 1003..	43,80 €
	AEM90-RT10-D20-M10-L25-Z03-H	20	3	18	M10	25	10.5	SFTY UCUNA	50,20 €
	AEM90-RT10-D25-M12-L30-Z04-H	25	4	21	M12	30	12.5	UYGUNDUR.	53,90 €
	AEM90-RT10-D32-M16-L43-Z05-H	32	5	29	M16	43	17		57,30 €
	AEM90-RT10-D42-M16-L43-Z06-H	42	6	29	M16	43	17		63,60 €
 <p>YENİ</p> <p>90°</p>	AEM90-TNG10-D21-M10-L25-Z03-H	21	3	18	M10	25	10.5	RT 1003..	56,40 €
	AEM90-TNG10-D26-M12-L30-Z04-H	26	4	21	M12	30	12.5	SFTY UCUNA	62,30 €
	AEM90-TNG10-D33-M16-L43-Z05-H	33	5	29	M16	43	17	UYGUNDUR.	68,80 €
	AEM90-TNG10-D35-M16-L43-Z05-H	35	5	29	M16	43	17		68,80 €

S SİSTEM MODÜLER PARMAK FREZELER

	TAKIM KODU	TAKIM ÖLÇÜLERİ (mm)						KESİCİ UÇ	FİYAT
		DC	ZEFP	DCSFMS	TDZ	LF	DCON		
 90°	AEM90-WN0604Z-D25-M12-L35-Z02-H	25	2	21	M12	35	12.5	WNHU 0604..	52,70 €
	AEM90-WN0604Z-D32-M16-L43-Z03-H	32	3	29	M16	43	17	ZCC UCUNA	58,00 €
	AEM90-WN0604Z-D40-M16-L43-Z04-H	40	4	29	M16	43	17	UYGUNDUR.	65,90 €
 90°	AEM90-3P1004-D20-M10-L35-Z02	20	2	18	M10	35	10.5	3PT 1004	55,10 €
	AEM90-3P1004-D32-M16-L43-Z05-H	32	5	29	M16	43	17	TGTC UCUNA	66,20 €
								UYGUNDUR.	
 95°	AEM95-XD0206-D16-M08-L23-Z02-H	16	2	14.75	M08	23	8.5		40,10 €
	AEM95-XD0206-D16-M08-L23-Z02-H-F	16	2	14.75	M08	23	8.5	XDHW 0206..	59,90 €
	AEM95-XD0206-D20-M10-L30-Z03-H	20	3	18	M10	30	10.5	DJT UCUNA	45,70 €
	AEM95-XD0206-D20-M10-L30-Z03-H-F	20	3	18	M10	30	10.5	UYGUNDUR.	68,30 €
	AEM95-XD0206-D25-M12-L35-Z03-H	25	3	21	M12	35	12.5		47,80 €
	AEM95-XD0206-D25-M12-L35-Z03-H-F	25	3	21	M12	35	12.5		71,10 €
	AEM95C-XD0310-D35-M16-L43-Z03-H	35	3	29	M16	43	17		51,90 €
	AEM95C-XD0310-D35-M16-L43-Z03-H-F	35	3	29	M16	43	17	XDHW 0310..	78,40 €
	AEM95C-XD0310-D42-M16-L43-Z04-H	42	4	29	M16	43	17	DJT UCUNA	57,30 €
	AEM95C-XD0310-D42-M16-L43-Z04-H-F	42	4	29	M16	43	17	UYGUNDUR.	85,30 €
 -°	AEMR-RC10T3-D25-M12-L35-Z03-H	25	3	21	M12	35	12.5	RC.. 10T3..	51,90 €
	AEMR-RC10T3-D32-M16-L43-Z04-H	32	4	29	M16	43	17	ZCC UCUNA	57,30 €
	AEMR-RC10T3-D40-M16-L43-Z05-H	40	5	29	M16	43	17	UYGUNDUR.	63,60 €
 -°	AEMR-RP08T2M-D20-M10-L30-Z02-H	20	2	18	M10	30	10.5	RPMT 08T2..	47,80 €
	AEMR-RP10T3M-D25-M12-L35-Z02-H	25	2	21	M12	35	12.5	RPMT 10T3..	49,40 €
	AEMR-RP10T3M-D32-M16-L43-Z03-H	32	3	29	M16	43	17	MTSBSH	62,50 €
	AEMR-RP1204M-D32-M16-L43-Z03-H	32	3	29	M16	43	17	RPMT 1204..	62,50 €
	AEMR-RP1204M-D40-M16-L43-Z04-H	40	4	29	M16	43	17	MTSBSH UCUNA	63,60 €
								UYGUNDUR.	
 -°	AEMR-RP10T3-D25-M12-L35-Z02-H	25	2	21	M12	35	12.5	RPNX 10T3..	53,90 €
	AEMR-RP10T3-D32-M16-L43-Z03-H	32	3	29	M16	43	17	CRTZT UCUNA	59,70 €
	AEMR-RP1204-D32-M16-L43-Z03-H	32	3	29	M16	43	17	UYGUNDUR.	59,70 €

S SİSTEM MODÜLER PARMAK FREZELER

110/111

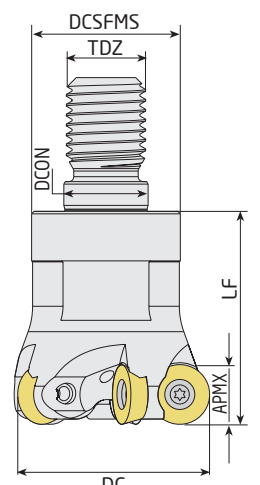

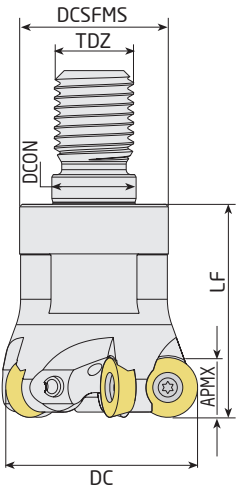

	TAKIM KODU	TAKIM ÖLÇÜLERİ (mm)						KESİCİ UÇ	FİYAT
		DC	ZEFP	DCSFMS	TDZ	LF	DCON		
	AEMR-RY10-D32-M16-L43-Z04-H	32	4	29	M16	43	17	RYMX 1004..	65,90 €
	AEMR-RY10-D40-M16-L43-Z05-H	40	5	29	M16	43	17	TGTC UCUNA UYGUNDUR.	72,40 €
	AEMR-RY12-D32-M16-L43-Z03-H	32	3	29	M16	43	17	RYMX 1205..	59,50 €
	AEMR-RY12-D40-M16-L43-Z03-H	40	3	29	M16	43	17	TGTC UCUNA UYGUNDUR.	64,70 €
  	AEMR-RD0702-D15-M08-L23-Z02-H	15	2	13	M08	23	8.5		45,70 €
	AEMR-RD0702-D16-M08-L23-Z02-H	16	2	13	M08	23	8.5		45,70 €
	AEMR-RD0702-D20-M10-L30-Z04-H	20	4	18	M10	30	10.5		55,80 €
	AEMR-RD0702-D25-M12-L35-Z05-H	25	5	21	M12	35	12.5		59,70 €
	AEMR-RD0702-D30-M16-L42-Z05-H	30	5	29	M16	42	17	RD.. 0702	61,90 €
	AEMR-RD0702-D32-M16-L43-Z05-H	32	5	29	M16	43	17	ISO	61,90 €
	AEMR-RD0702-D35-M16-L42-Z06-H	35	6	29	M16	42	17		65,50 €
	AEMR-RD0702-D42-M16-L43-Z05-H	42	5	29	M16	43	17		65,50 €
	AEMR-RD0702-D42-M16-L43-Z07-H	42	7	29	M16	43	17		73,30 €
	AEMR-RD08T2-D16-M08-L23-Z02-H	16	2	13	M08	23	8.5		45,70 €
	AEMR-RD08T2-D16-M10-L23-Z02-H	16	2	13	M10	23	8.5	RD.. 08T2	45,70 €
	AEMR-RD08T2-D20-M10-L30-Z03-H	20	3	18	M10	30	10.5	ISO	51,90 €
	AEMR-RD08T2-D25-M12-L35-Z04-H	25	4	21	M12	35	12.5		57,30 €
	AEMR-RD0802-D16-M08-L23-Z02-H	16	2	13	M08	23	8.5	RD.. 0802	45,70 €
	AEMR-RD0803-D16-M08-L23-Z02-H	16	2	13	M08	23	8.5		45,70 €
	AEMR-RD0803-D20-M10-L30-Z03-H	20	3	18	M10	30	10.5	RD.. 0803	51,90 €
	AEMR-RD0803-D25-M12-L35-Z04-H	25	4	21	M12	35	12.5	ISO	57,30 €
	AEMR-RD1003-D20-M10-L30-Z02-H	20	2	18	M10	30	10.5		47,80 €
	AEMR-RD1003-D25-M12-L35-Z02-H	25	2	21	M12	35	12.5		49,40 €
	AEMR-RD1003-D25-M12-L35-Z03-H	25	3	21	M12	35	12.5		51,90 €
	AEMR-RD1003-D30-M16-L43-Z04-H	30	4	29	M16	43	17	RD.. 1003	57,30 €
	AEMR-RD1003-D32-M16-L43-Z04-H	32	4	29	M16	43	17	ISO	57,30 €
	AEMR-RD1003-D35-M16-L43-Z04-H	35	4	29	M16	43	17		59,70 €
	AEMR-RD1003-D40-M16-L43-Z05-H	40	5	29	M16	43	17		63,60 €
	AEMR-RD1003-D42-M16-L43-Z05-H	42	5	29	M16	43	17		65,50 €
	AEMR-RD1004-D25-M12-L35-Z03-H	25	3	21	M12	35	12.5	RD.. 1004	51,90 €
	AEMR-RD1004-D32-M16-L43-Z04-H	32	4	29	M16	43	17	ISO	57,30 €
	AEMR-RD10T3-D25-M12-L35-Z03-H	25	3	21	M12	35	12.5	RD.. 10T3	51,90 €
	AEMR-RD10T3-D32-M16-L45-Z04-H	32	4	29	M16	45	17	ISO	57,30 €
	AEMR-RD12T3-D24-M12-L35-Z02-H	24	2	21	M12	35	12.5		51,90 €
	AEMR-RD12T3-D25-M12-L35-Z02-H	25	2	21	M12	35	12.5		51,90 €
	AEMR-RD12T3-D32-M16-L43-Z03-H	32	3	29	M16	43	17	RD.. 12T3	53,90 €
AEMR-RD12T3-D35-M16-L43-Z03-H	35	3	29	M16	43	17	ISO	55,80 €	
AEMR-RD12T3-D35-M16-L43-Z04-H	35	4	29	M16	43	17		59,70 €	
AEMR-RD12T3-D40-M16-L43-Z04-H	40	4	29	M16	43	17		63,60 €	
AEMR-RD12T3-D42-M16-L43-Z05-H	42	5	29	M16	43	17		65,50 €	
AEMR-RD1204-D32-M16-L43-Z03-H	32	3	29	M16	43	17	RD.. 1204	53,90 €	
AEMR-RD1204-D42-M16-L43-Z04-H	42	4	29	M16	43	17	ISO	63,60 €	
AEMR-RD1604-D32-M16-L43-Z02-H	32	2	29	M16	43	17		53,90 €	
AEMR-RD1604-D40-M16-L43-Z02-H	40	2	29	M16	43	17	RD.. 1604	63,60 €	
AEMR-RD1604-D42-M16-L43-Z03-H	42	3	29	M16	43	17	ISO	69,40 €	



S SİSTEM MODÜLER PARMAK FREZELER

	TAKIM KODU	TAKIM ÖLÇÜLERİ (mm)						KESİCİ UÇ	FİYAT
		DC	ZEFP	DCSFMS	TDZ	LF	DCON		
	AEMR-QP10T3-D25-M12-L35-Z02-H	25	2	21	M12	35	12.5	QP.. 10T3..	59,70 €
	AEMR-QP10T3-D32-M16-L43-Z03-H	32	3	29	M16	43	17	SMTM UCUNA UYGUNDUR.	66,20 €

S SİSTEM HIZLI İLERLEMELİ MODÜLER PARMAK FREZELER

	TAKIM KODU	TAKIM ÖLÇÜLERİ (mm)						KESİCİ UÇ	FİYAT
		DC	ZEFP	DCSFMS	TDZ	LF	DCON		
	YENİ AHFM-BL0603-D20-M10-L30-Z03-H	20	3	18	M10	30	10.5	BLMP 0603	50,40 €
	AHFM-BL0603-D32-M16-L40-Z05-H	32	5	29	M16	40	17		60,50 €
	AHFM-BL0904-D32-M16-L40-Z04-H	32	4	29	M16	40	17	BLMP 0904	60,50 €
	YENİ AHFM-BL0904-D32-M16-L43-Z04-H	32	4	29	M16	43	17	TGTC UCUNA	60,50 €
	AHFM-BL0904-D42-M16-L43-Z05-H	42	5	29	M16	43	17	UYGUNDUR.	65,50 €
	AHFM-ED0702-D12-M06-L20-Z03	12	3	10	M06	20	6.5	EDMT 0702	49,10 €
	AHFM-ED0702-D16-M08-L25-Z04-H	16	4	14.75	M08	25	8.5	JDMT 070204	56,90 €
	AHFM-ED0702-D20-M10-L30-Z05-H	20	5	18	M10	30	10.5	HTCH UCUNA	64,70 €
	AHFM-ED0702-D25-M12-L30-Z06-H	25	6	21	M12	30	12.5	UYGUNDUR.	74,10 €
	AHFM-ED0702-D32-M16-L30-Z08-H	32	8	29	M16	30	17		89,20 €
	AHFM-EP1003-D16-M08-L23-Z02-H	16	2	14.75	M08	23	8.5	EP.. 1003..	40,10 €
	AHFM-EP1003-D20-M10-L30-Z04-H	20	4	18	M10	30	10.5	ZPMT 1003..	50,40 €
	AHFM-EP1003-D25-M12-L35-Z04-H	25	4	21	M12	35	12.5	YPHW 1003..	57,10 €
	AHFM-EP1003-D32-M16-L43-Z05-H	32	5	29	M16	43	17	DJT UCUNA	61,60 €
	AHFM-EP1003-D35-M16-L43-Z05-H	35	5	29	M16	43	17	UYGUNDUR.	61,60 €
	AHFM-EP1003-D42-M16-L43-Z06-H	42	6	29	M16	43	17		62,50 €
	AHFM-EN1004-D16-M08-L23-Z02-H	16	2	14.75	M8	23	8.5		44,10 €
	AHFM-EN1004-D20-M10-L30-Z03-H	20	3	18	M10	30	10.5		50,40 €
	AHFM-EN1004-D25-M12-L35-Z03-H	25	3	21	M12	35	12.5	ENMU 1004..	52,60 €
	AHFM-EN1004-D25-M12-L35-Z04-H	25	4	21	M12	35	12.5	DJT UCUNA	58,00 €
	AHFM-EN1004-D32-M16-L43-Z05-H	32	5	29	M16	43	17	UYGUNDUR.	63,10 €
	AHFM-EN1004-D35-M16-L43-Z05-H	35	5	29	M16	43	17		63,10 €
	AHFM-EN1004-D40-M16-L43-Z05-H	40	5	29	M16	43	17		63,10 €
	AHFM-EN1004-D42-M16-L43-Z05-H	42	5	29	M16	43	17		63,10 €
	AHFM-LN0303-D25-M12-L35-Z04-H	25	4	21	M12	35	12.5	LNMU 0303..	62,10 €
	AHFM-LN0303-D32-M16-L43-Z05-H	32	5	29	M16	43	17	TNGLY UCUNA	73,70 €
	AHFM-LN0303-D42-M16-L43-Z06-H	42	6	29	M16	43	17	UYGUNDUR.	85,70 €

S SİSTEM HIZLI İLERLEMELİ MODÜLER PARMAK FREZELER

112/113

	TAKIM KODU	TAKIM ÖLÇÜLERİ (mm)						KESİCİ UÇ	FİYAT
		DC	ZEFP	DCSFMS	TDZ	LF	DCON		
	AHFM-L003-D20-M10-L30-Z04-H-F	20	4	18	M10	30	10.5		93,10 €
	AHFM-L003-D25-M12-L35-Z04-H-F	25	4	21	M12	35	12.5		93,10 €
	AHFM-L003-D25-M12-L35-Z04-H	25	4	21	M12	35	12.5		62,10 €
	AHFM-L003-D32-M16-L40-Z05-H-F	32	5	29	M16	40	17		111,20 €
	AHFM-L003-D32-M16-L40-Z05-H	32	5	29	M16	40	17	LOGU 0303..	73,70 €
	AHFM-L003-D32-M16-L40-Z06-H-F	32	6	29	M16	40	17	KYCR UCUNA	120,30 €
	AHFM-L003-D32-M16-L40-Z06-H	32	6	29	M16	40	17	UYGUNDUR.	80,20 €
	YENİ AHFM-L003-D35-M16-L40-Z05-H	35	5	29	M16	40	17		73,70 €
	YENİ AHFM-L003-D35-M16-L40-Z06-H	35	6	29	M16	40	17		80,20 €
	AHFM-L003-D42-M16-L40-Z05-H	42	5	29	M16	40	17		91,80 €
AHFM-L003-D42-M16-L40-Z06-H	42	6	29	M16	40	17		102,20 €	
	AHFM-JD1003-D16-M08-L30-Z02-H	16	2	14.75	M8	30	8.5	JDMT 1003..	56,80 €
	AHFM-JD1003-D20-M10-L30-Z03-H	20	3	18	M10	30	10.5	HTCH UCUNA UYGUNDUR.	64,40 €
	AHFMC-JD1204-D32-M16-L43-Z02-H	32	2	29	M16	43	17	JDMW 1204..	62,10 €
	AHFMC-JD1204-D42-M16-L43-Z03-H	42	3	29	M16	43	17	MTSBH UCUNA UYGUNDUR.	85,30 €
	AHFM-SD06T2-D16-M08-L23-Z02-H	16	2	14.75	M08	23	8.5	SD.. 06T2..	52,70 €
	AHFM-SD06T2-D20-M10-L30-Z03-H	20	3	18	M10	30	10.5	ZCC UCUNA	59,90 €
	AHFM-SD06T2-D25-M12-L35-Z04-H	25	4	21	M12	35	12.5	UYGUNDUR.	69,40 €
	AHFMC-SD09T3-D25-M12-L30-Z02-H	25	2	22	M12	30	12.5	SD.. 09T3..	53,90 €
	AHFMC-SD09T3-D32-M16-L43-Z03-H	32	3	29	M16	43	17	ZCC UCUNA	68,30 €
	AHFMC-SD09T3-D35-M16-L43-Z03-H	35	3	29	M16	43	17	UYGUNDUR.	68,30 €
	AHFMC-SD09T3-D40-M16-L43-Z04-H	40	4	29	M16	43	17		74,60 €
	AHFMC-SD1204-D32-M16-L43-Z02-H	32	2	29	M16	43	17	SD.. 1204..	59,10 €
AHFMC-SD1204-D40-M16-L43-Z03-H	40	3	29	M16	43	17	ZCC UCUNA UYGUNDUR.	68,30 €	
	AHFM-SO0803-D20-M10-L30-Z02-H	20	2	18	M10	30	10.5		48,30 €
	AHFM-SO0803-D25-M12-L35-Z03-H	25	3	22	M12	35	12.5	SOMW 080315	52,80 €
	AHFM-SO0803-D32-M16-L43-Z03-H	32	3	29	M16	43	17	KPTK UCUNA	52,80 €
	AHFM-SO0803-D32-M16-L43-Z04-H	32	4	29	M16	43	17	UYGUNDUR.	56,90 €
	AHFM-SO0803-D40-M16-L43-Z04-H	40	4	29	M16	43	17		56,90 €
	AHFM-SO1004-D32-M16-L40-Z03-H	32	3	29	M16	40	17	SOMT 1004..	68,30 €
	AHFM-SO1004-D40-M16-L40-Z04-H	40	4	29	M16	40	17	KYCR UCUNA	74,50 €
	AHFM-SO1004-D42-M16-L40-Z04-H	42	4	29	M16	40	17	UYGUNDUR.	74,50 €

S SİSTEM HIZLI İLERLEMELİ MODÜLER PARMAK FREZELER

	TAKIM KODU	TAKIM ÖLÇÜLERİ (mm)						KESİCİ UÇ	FİYAT
		DC	ZEFP	DCSFMS	TDZ	LF	DCON		
	AHFM-YP1003-D16-M08-L23-Z02-F	16	2	14.75	M08	23	8.5		65,70 €
	AHFM-YP1003-D16-M08-L23-Z02-H-F	16	2	14.75	M08	23	8.5		65,70 €
	YENİ AHFM-YP1003-D17-M08-L23-Z02-H	17	2	14.75	M08	23	8.5		43,80 €
	AHFM-YP1003-D17-M08-L23-Z02-H-F	17	2	14.75	M08	23	8.5	EP.. 1003..	65,70 €
	YENİ AHFM-YP1003-D20-M10-L30-Z03-H	20	3	18	M10	30	10.5	YPHW 1003..	50,10 €
	AHFM-YP1003-D20-M10-L30-Z03-H-F	20	3	18	M10	30	10.5	ZPMT 1003..	75,10 €
	YENİ AHFM-YP1003-D20-M10-L30-Z04-H	20	4	18	M10	30	10.5	DJT UCUNA	56,30 €
	AHFM-YP1003-D20-M10-L30-Z04-F	20	4	18	M10	30	10.5	UYGUNDUR.	84,50 €
	YENİ AHFM-YP1003-D21-M10-L30-Z03-H	21	3	18	M10	30	10.5		50,10 €
	AHFM-YP1003-D21-M10-L30-Z03-H-F	21	3	18	M10	30	10.5		75,10 €
	YENİ AHFM-YP1003-D25-M12-L35-Z04-H	25	4	21	M12	35	12.5		56,30 €
	AHFM-YP1003-D25-M12-L35-Z04-F	25	4	21	M12	35	12.5		84,50 €
	AHFM-YP1003-D25-M12-L35-Z04-H-F	25	4	21	M12	35	12.5		84,50 €
	AHFM-YP1003-D26-M12-L35-Z04-H-F	26	4	21	M12	35	12.5		84,50 €
	AHFM-YP1003-D32-M16-L30-Z05-F	32	5	29	M16	30	17		93,90 €
	AHFM-YP1003-D32-M16-L43-Z05-H-F	32	5	29	M16	43	17		93,90 €
AHFM-YP1003-D40-M16-L43-Z06-H-F	40	6	29	M16	43	17		101,70 €	
AHFM-YP1003-D42-M16-L43-Z06-H-F	42	6	29	M16	43	17		101,70 €	
	YENİ AHFM-SP1004-D25-M12-L35-Z02-H	25	4	21	M12	35	12.5	SPNW 1004..	57,30 €
	AHFM-SP1004-D32-M16-L43-Z03-H	32	3	29	M16	43	17	DJT UCUNA	68,30 €
	AHFM-SP1004-D35-M16-L43-Z03-H	35	3	29	M16	43	17	UYGUNDUR.	68,30 €
	AHFM-SP1004-D42-M16-L43-Z04-H	42	4	29	M16	43	17		74,50 €
	AHFMC-WD0804-D25-M12-L35-Z02-H	25	2	21	M12	35	12.5	WDMT 0804..	66,20 €
	AHFMC-WD0804-D32-M16-L35-Z03-H	32	3	29	M16	35	17	SMTM UCUNA	78,40 €
								UYGUNDUR.	
	AHFM-WD0503D-D20-M10-L30-Z02-H	20	2	18	M10	30	10.5	WDMT 0503..	53,90 €
	AHFM-WD0503D-D25-M12-L35-Z03-H	25	3	21	M12	35	12.5	DJT UCUNA	59,70 €
	AHFM-WD0503D-D32-M16-L43-Z04-H	32	4	29	M16	43	17	UYGUNDUR.	68,30 €
	AHFM-WD0503D-D40-M16-L43-Z05-H	40	5	29	M16	43	17		75,90 €
	AHFMC-WD06T3D-D35-M16-L43-Z03-H	35	3	29	M16	43	17	WDHW 06T3..	65,90 €
	AHFMC-WD0805D-D32-M16-L43-Z02-H	32	2	29	M16	43	17	WDHW 0805..	98,30 €
								DJT UCUNA	
							UYGUNDUR.		
	AHFM-WN09T3-D32-M16-L40-Z03-H	32	3	29	M16	40	17	WNMX 09T3..	55,20 €
	AHFM-WN09T3-D40-M16-L40-Z04-H	40	4	29	M16	40	17	KRLY UCUNA	62,10 €
								UYGUNDUR.	

KÜRE UÇLU PARMAK FREZELER



114/115

	TAKIM KODU	KESİCİ UÇ	FİYAT
	APMR-BNM12-D12-C12-L130	BNM 120-S	57,10 €
	APMR-BNM16-D16-C16-L175	BNM 160-S	52,60 €
	YENİ APMR-BNM16-D16-C16-L200	DJT UCUNA UYGUNDUR.	57,10 €
	YENİ APMR-BNM20-D20-C20-L160	BNM 200-S	54,30 €
	YENİ APMR-BNM20-D20-C20-L200	DJT UCUNA	59,50 €
	YENİ APMR-BNM20-D20-C20-L250	UYGUNDUR.	68,10 €
	YENİ APMR-BNM25-D25-C25-L160	BNM 250-S	53,20 €
	YENİ APMR-BNM25-D25-C25-L200	DJT UCUNA	66,50 €
YENİ APMR-BNM25-D25-C25-L250	UYGUNDUR.	83,10 €	
	APMR-P3208-D08-C10-L110	P3208 - WLTR	51,90 €
	APMR-P3210-D10-C10-L130	P3210 - WLTR	51,90 €
	APMR-P3210-D10-C12-L130	P3210 - WLTR	51,90 €
	APMR-P3212-D12-C12-L130	P3212 - WLTR	51,90 €
	APMR-P3216-D16-C16-L175	P3216 - WLTR	47,80 €
	APMR-P3220-D20-C20-L200	P3220 - WLTR	51,90 €
	APMR-P3225-D25-C25-L200	P3225 - WLTR	55,80 €
	APMR-P3232-D32-C32-L200	P3232 - WLTR	57,30 €
	WLTR UCUNA UYGUNDUR.		
	APMR-R012-D12-C12-L120	ROHX 1203	45,70 €
	APMR-R012-D12-C16-L160	ZCC	47,80 €
	APMR-R016-D16-C16-L160	ROHX 1604	47,80 €
	APMR-R016-D16-C16-L200	ZCC UCUNA	51,90 €
	APMR-R016-D16-C20-L200	UYGUNDUR.	51,90 €
	APMR-R020-D20-C20-L160	ROHX 2005	49,40 €
	APMR-R020-D20-C20-L200	ZCC UCUNA	54,10 €
	APMR-R020-D20-C25-L220	UYGUNDUR.	57,30 €
	APMR-XP16-D16-C16-L150	XPHT 16R0803	47,80 €
	APMR-XP20-D20-C20-L150	XPHT 20R10T3	49,40 €
	APMR-XP25-D25-C25-L150	XPHT 25R1204	53,00 €
		ZCC UCUNA	
	UYGUNDUR.		

VİDALI KÜRE UÇLU PARMAK FREZELER

	TAKIM KODU	KESİCİ UÇ	FİYAT
	APMR-BNM12-D12-M06-L20	BNM 120-S	46,90 €
	APMR-BNM16-D16-M08-L23	BNM 160-S	54,30 €
	APMR-BNM20-D20-M10-L30	BNM 200-S	57,10 €
		DJT UCUNA	
		UYGUNDUR.	

VİDALI KÜRE UÇLU PARMAK FREZELER

	TAKIM KODU	KESİCİ UÇ	FİYAT
	APMR-P3216-D16-M08-L25	P3216 - WLTR	49,40 €
	APMR-P3220-D20-M10-L30	P3220 - WLTR	51,90 €
	APMR-P3225-D25-M12-L35	P3225 - WLTR	55,80 €
	APMR-P3232-D32-M16-L43	P3232 - WLTR	57,80 €
		WLTR UCUNA UYGUNDUR.	
	APMR-XP16-D16-M08-L25	XPHT 16R0803	51,70 €
	APMR-XP20-D20-M10-L30	XPHT 20R10T3	55,20 €
	APMR-XP25-D25-M12-L40	XPHT 25R1204	58,60 €
		ZCC UCUNA UYGUNDUR.	
	APMR-SWB225-D25-M12-L35	SWB225HM-HS	64,40 €
	APMR-SWB230-D30-M16-L43	SWB230HM-HS	65,20 €
	APMR-SWB232-D32-M16-L43	SWB232HM-HS	65,90 €
		DJT UCUNA UYGUNDUR.	

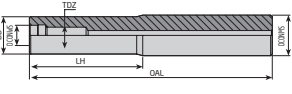

VİDALI TAKIM TUTUCULARI

	TAKIM KODU	TAKIM ÖLÇÜLERİ (mm)						FİYAT
		DCONMS	TDZ	DCONWS	BD	OAL	LH	
 	AVTT-D13-C16-M08-L100-H	16	8	8.5	13	100	40	40,10 €
	AVTT-D15-C16-M08-L130-H	16	8	8.5	15	130	70	44,20 €
	AVTT-D18-C20-M10-L130-H	20	10	10.5	18	130	70	44,20 €
	AVTT-D18-C20-M10-L160-H	20	10	10.5	18	160	80	47,80 €
	AVTT-D23-C25-M12-L150-H	25	12	12.5	23	150	70	51,90 €
	AVTT-D23-C25-M12-L200-H	25	12	12.5	23	200	100	68,10 €
	AVTT-D23-C25-M12-L250-H	25	12	12.5	23	250	150	81,70 €
	AVTT-D30-C32-M16-L150-H	32	16	17	30	150	70	53,90 €
	AVTT-D30-C32-M16-L200-H	32	16	17	30	200	100	69,40 €
	AVTT-D30-C32-M16-L250-H	32	16	17	30	250	150	83,60 €
AVTT-D30-C32-M16-L300-H	32	16	17	30	300	200	89,70 €	

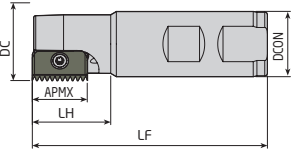

DİŞ AÇMA FREZELEME TAKIMLARI

	TAKIM KODU	TAKIM ÖLÇÜLERİ (mm)						KESİCİ UÇ	FİYAT
		DC	ZEFP	DCON	LF	LH	APMX		
	ATM-H23-D23-C25-L100-Z02-H	23	2	25	100	30	27	H23	85,30 €
	ATM-H32-D32-C32-L130-Z05-H	32	5	32	130	35	32	H32	99,60 €
									CPT UCUNA UYGUNDUR.



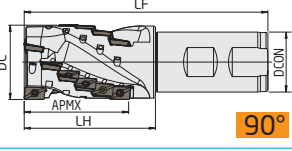

DİŞ AÇMA FREZELEME TAKIMLARI

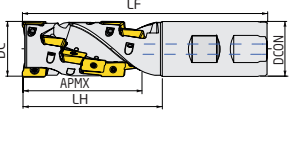
	TAKIM KODU	TAKIM ÖLÇÜLERİ (mm)						KESİCİ UÇ	FİYAT	
		DC	ZEFP	DCON	LF	LH	APMX			
 	ATM-C14-D14-W20-L100-Z01-H	14	1	20	100	25	14	C14	40,10 €	
	ATM-C21-D18-W20-L100-Z01-H	18	1	20	100	30	21		47,80 €	
	ATM-C21-D21-W25-L125-Z01-H	21	1	25	125	40	21		51,90 €	
	ATM-C21-D25-W20-L125-Z01-H	25	1	20	125	30	21	C21	51,90 €	
	ATM-C21-D28-W25-L90-Z01-H	28	1	25	90	30	21	CPT UCUNA	65,50 €	
	ATM-C21-D38-W32-L90-Z03-H	38	3	32	90	21	31	UYGUNDUR.	71,60 €	
	ATM-C21-D38-W32-L120-Z03-H	38	3	32	120	30	21		71,60 €	
	ATM-C21-D43-W32-L90-Z03-H	43	3	32	90	30	21		77,80 €	
 	ATM-C30-D29-W25-L150-Z01-H	29	1	25	150	50	30	C30	75,90 €	
								CPT UCUNA		
								UYGUNDUR.		
	ATM60-TB0601-D13-C10-L150-Z02-H	60	13	10	2.5	150	40	3.3	TBGT 060102	51,30 €
	ATM60-TC0902-D20.5-C16-L150-Z02-H	60	20.5	16	5.2	150	40	4.7	TC.T 090202	51,30 €
	ATM60-TC1102-D26-C20-L150-Z03-H	60	26	20	8.3	150	50	5.4	TC.T 110202	59,70 €
ATM60-TC16T3-D32-C25-L150-Z02-H	60	32	25	6.4	150	50	8	TC.T 16T304	62,50 €	
ATM60-TC16T3-D40-C32-L250-Z03-H	60	40	32	13.7	250	50	8	ISO	89,70 €	

S SİSTEM HELİS FREZELER

	TAKIM KODU	ZEFP		TAKIM ÖLÇÜLERİ (mm)					KESİCİ UÇ	FİYAT
		Toplam	Etkili	DC	DCON	APMX	LH	LF		
 	AHM90-AP10-D20-W20-L087-Z04	4	2	20	20	28	37	87		98,30 €
	YENİ AHM90-AP10-D20-W20-L087-Z0204	4	2	20	20	28	37	87	AP..	98,30 €
	YENİ AHM90-AP10-D20-W20-L087-Z0206	6	2	20	20	28	37	87	1003..	108,60 €
	AHM90-AP10-D20-W20-L087-Z0206-H	6	2	20	20	28	37	87	ISO	108,60 €
	AHM90-AP10-D25-W25-L105-Z0208-H	8	2	25	25	37	47	105		130,40 €
	AHM90-AP10-D32-W32-L115-Z0315-H	15	3	32	32	46	55	115		175,40 €
	AHM90-AP10-D40-W32-L130-Z0318-H	18	3	40	32	55	64	130		199,10 €
 	AHM90-AP1204-D32-W32-L140-Z0212-H	12	2	32	32	68	80	140	AP.. 1204..	143,50 €
	AHM90-AP1204-D40-W32-L160-Z0321-H	21	3	40	32	79	100	160	TGTC UCUNA	233,00 €
									UYGUNDUR.	

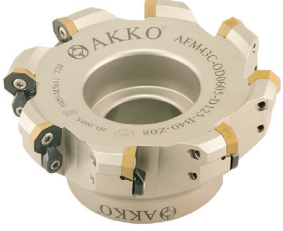
YÜZEY FREZELER

	TAKIM KODU	TAKIM ÖLÇÜLERİ (mm)					KESİCİ UÇ	FİYAT
		DC	ZEPF	DCON	LF	APMX		
 42°	AFM42C-XD0806-D063-A27-Z04-H	63	4	27	50	12		71,10 €
	AFM42C-XD0806-D080-A27-Z05-H	80	5	27	50	12	XDMW 0806..	85,30 €
	AFM42C-XD0806-D100-A32-Z06-H	100	6	32	63	12	DJT UCUNA	96,80 €
	AFM42C-XD0806-D125-B40-Z07	125	7	40	63	12	UYGUNDUR.	128,00 €
	AFM42C-XD0806-D160-C40-Z08	160	8	40	63	12		156,50 €
	AFM42C-XD0806-D200-C60-Z09	200	9	60	63	12		234,90 €
 43°	AFM43-OD0504-D040-A16-Z04-H	40	4	16	40	3.5		40,10 €
	AFM43-OD0504-D050-A22-Z05-H	50	5	22	40	3.5	OD.. 0504..	47,80 €
	AFM43-OD0504-D063-A22-Z06-H	63	6	22	40	3.5	WLTR UCUNA	55,80 €
	AFM43-OD0504-D080-A27-Z07-H	80	7	27	50	3.5	UYGUNDUR.	63,60 €
	AFM43-OD0504-D100-A32-Z08-H	100	8	32	50	3.5		79,30 €
 43°	AFM43C-OD0605-D080-A27-Z06-H	80	6	27	50	4	OD.. 0605..	86,20 €
	AFM43C-OD0605-D100-A32-Z07-H	100	7	32	50	4	WLTR-LMNA UCUNA	96,60 €
	AFM43C-OD0605-D125-B40-Z08	125	8	40	63	4	UYGUNDUR.	120,50 €
 43°	AFM43-OF05T3-D050-A22-Z05-H	50	5	22	40	3	OF.. 05T3..	53,90 €
	AFM43-OF05T3-D063-A22-Z06-H	63	6	22	40	3	ISO	61,90 €
	AFM43-OF05T3-D080-A27-Z07-H	80	7	27	50	3		69,40 €
	AFM43-OF05T3-D125-B40-Z09	125	9	40	63	3		140,90 €
 43°	AFM43-ON0604-D050-A22-Z05-H	50	5	22	40	4		55,80 €
	AFM43-ON0604-D063-A22-Z06-H	63	6	22	40	4	ON.. 0604..	65,50 €
	AFM43-ON0604-D080-A27-Z07-H	80	7	27	50	4	ZCC UCUNA	75,90 €
	AFM43-ON0604-D100-A32-Z08-H	100	8	32	50	4	UYGUNDUR.	95,70 €
	AFM43-ON0604-D125-B40-Z09	125	9	40	63	4		127,60 €

YÜZEY FREZELER

	TAKIM KODU	TAKIM ÖLÇÜLERİ (mm)					KESİCİ UÇ	FİYAT
		DC	ZEP	DCON	LF	APMX		
 <p>44°</p>	AFM44-ON0606-D063-A22-Z06-H	63	6	22	40	3,8	ONHX 0606..	65,50 €
	AFM44-ON0606-D080-A27-Z08-H	80	8	27	50	3,8	PLBT UCUNA	75,90 €
	AFM44-ON0606-D100-A32-Z10-H	100	10	32	50	3,8	UYGUNDUR.	95,70 €
 <p>45°</p>	AFM45-HN0905-D050-A22-Z05-H	50	5	22	40	4,5		72,80 €
	AFM45-HN0905-D063-A22-Z06-H	63	6	22	40	4,5		82,30 €
	AFM45-HN0905-D080-A27-Z07-H	80	7	27	50	4,5	HN.. 0905..	93,50 €
	AFM45L-HN0905-D100-A32-Z08-H	100	8	32	50	4,5	WDA-KNMTL UCUNA	105,80 €
	AFM45-HN0905-D125-B40-Z10	125	10	40	63	4,5	UYGUNDUR.	119,40 €
	AFM45-HN0905-D160-C40-Z12	160	12	40	63	4,5		147,80 €
	AFM45L-HN0905-D160-C40-Z12	160	12	40	63	4,5		147,80 €
	AFM45-HN0905-D200-C60-Z16	200	16	60	63	4,5		250,40 €
	AFM45L-HN0905-D200-C60-Z16	200	16	60	63	4,5		250,40 €
 <p>45°</p>	AFM45-NN2007-D100-A32-Z07-H	100	7	32	50	6	NNMU 2007..	85,60 €
	AFM45-NN2007-D125-B40-Z08	125	8	40	63	6	MTSBSH UCUNA	101,90 €
	AFM45-NN2007-D160-C40-Z10	160	10	40	63	6	UYGUNDUR.	135,30 €
 <p>45°</p>	AFM45-SE12-D050-A22-Z04-H	50	4	22	40	6		47,80 €
	AFM45L-SE12-D050-A22-Z04-H	50	4	22	40	6	SE.. 12T3..	47,80 €
	AFM45-SE12-D063-A22-Z05-H	63	5	22	40	6	ZCC UCUNA	55,80 €
	AFM45L-SE12-D063-A22-Z05-H	63	5	22	40	6	UYGUNDUR.	55,80 €
	AFM45-SE12-D080-A27-Z06-H	80	6	27	50	6		63,60 €
	AFM45L-SE12-D080-A27-Z06-H	80	6	27	50	6	R245-12T3..	63,60 €
	AFM45-SE12-D100-A32-Z07-H	100	7	32	50	6	SNDVK UCUNA	79,30 €
	AFM45-SE12-D125-B40-Z08	125	8	40	63	6	UYGUNDUR.	105,60 €
	AFM45-SE12-D160-C40-Z10	160	10	40	63	6		131,50 €
	AFM45L-SE12-D160-C40-Z10	160	10	40	63	6		131,50 €
	AFM45-SE12-D200-C60-Z12	200	12	60	63	6		159,10 €
	AFM45-SE14M4-D063-A22-Z04-H	63	4	22	40	7		59,70 €
	AFM45-SE14M4-D080-A27-Z05-H	80	5	27	50	7	SE.. 14M4..	69,40 €
	AFM45-SE14M4-D100-A32-Z05-H	100	5	32	50	7	KRLY UCUNA	85,60 €
	AFM45-SE14M4-D125-B40-Z06	125	6	40	63	7	UYGUNDUR.	113,40 €
	AFM45-SE14M4-D160-C40-Z07	160	7	40	63	7		139,70 €

YÜZEY FREZELER

	TAKIM KODU	TAKIM ÖLÇÜLERİ (mm)					KESİCİ UÇ	FİYAT
		DC	ZEP	DCON	LF	APMX		
	AFM45-SE13-D050-A22-Z04-H	50	4	22	40	6		58,40 €
	AFM45-SE13-D063-A22-Z05-H	63	5	22	40	6		68,30 €
	AFM45-SE13-D080-A27-Z06-H	80	6	27	50	6	SEMT 13T3..	76,70 €
	AFM45S-SE13-D050-A22-Z05-H	50	5	22	40	6	SMTM-DJT UCUNA	92,70 €
	AFM45S-SE13-D063-A22-Z06-H	63	6	22	40	6	UYGUNDUR.	108,20 €
	AFM45S-SE13-D080-A27-Z08-H	80	8	27	50	6		135,30 €
	AFM45S-SE13-D100-A32-Z10-H	100	10	32	50	6		170,70 €
	AFM45S-SE13-D125-B40-Z12	125	12	40	63	6		219,00 €
45°								
	AFM45-SA1706-D080-A27-Z06-H	80	6	27	50	8.4	SAKU 1706..	75,90 €
	AFM45-SA1706-D100-A32-Z07-H	100	7	32	50	8.4	CRTZT UCUNA	85,60 €
	AFM45-SA1706-D125-B40-Z09	125	9	40	63	8.4	UYGUNDUR.	119,40 €
45°								
	AFM45C-SN12..-D050-A22-Z04-H	50	4	22	42	6		59,10 €
	YENI AFM45CL-SN12..-D050-A22-Z05-H	50	5	22	42	6		63,10 €
	AFM45C-SN12..-D050-A22-Z05-H	50	5	22	42	6		63,10 €
	AFM45C-SN12..-D063-A22-Z06-H	63	6	22	42	6		67,70 €
	AFM45C-SN12..-D063-A22-Z07-H	63	7	22	42	6		72,00 €
	AFM45CL-SN12..-D063-A22-Z07-H	63	7	22	42	6		72,00 €
	AFM45C-SN12..-D080-A27-Z07-H	80	7	27	52	6	SN.. 12...	79,10 €
	AFM45C-SN12..-D080-A27-Z08-H	80	8	27	52	6	WLTR-LMN-ACHTK	83,20 €
	AFM45CL-SN12..-D080-A27-Z08-H	80	8	27	52	6	UCUNA UYGUNDUR.	83,20 €
	AFM45C-SN12..-D100-A32-Z08-H	100	8	32	52	6		90,10 €
	AFM45C-SN12..-D100-A32-Z10-H	100	10	32	52	6		94,20 €
	AFM45CL-SN12..-D100-A32-Z10-H	100	10	32	52	6		94,20 €
	AFM45C-SN12..-D125-B40-Z11	125	11	40	65	6		131,50 €
	AFM45CL-SN12..-D125-B40-Z11	125	11	40	65	6		131,50 €
	AFM45C-SN12..-D160-C40-Z12	160	12	40	65	6		162,10 €
	AFM45C-SN12..-D200-C60-Z14	200	14	60	65	6		262,30 €
	AFM45CL-SN12..-D200-C60-Z14	200	14	60	65	6		262,30 €
	45°							

YÜZEY FREZELER

	TAKIM KODU	TAKIM ÖLÇÜLERİ (mm)					KESİCİ UÇ	FİYAT
		DC	ZEFP	DCON	LF	APMX		
 45°	AFM45C-ON0806-D080-A27-Z10	80	10	27	50	5.5	ON.. 0806..	135,90 €
	AFM45C-ON0806-D100-A32-Z14	100	14	32	50	5.5	ISO UCUNA	190,60 €
	AFM45C-ON0806-D125-B40-Z18	125	18	40	63	5.5	UYGUNDUR.	251,90 €
	AFM45C-ON0806-D160-C40-Z22	160	22	40	63	5.5		315,30 €
 45°	AFM45-XN0906-D063-A22-Z06-H	63	6	22	50	5	XNMU 0906..	82,20 €
	AFM45-XN0906-D080-A27-Z06-H	80	6	27	50	5	TGTC UCUNA	87,40 €
	AFM45-XN0906-D100-A32-Z07-H	100	7	32	55	5	UYGUNDUR.	99,10 €
	AFM45-XN0906-D125-B40-Z08	125	8	40	63	5		117,20 €
 66°	AFM66-PN0905-D050-A22-Z05	50	5	22	40	8	PNMU 0905..	62,50 €
	AFM66-PN0905-D063-A22-Z06	63	6	22	40	8	KYCR UCUNA	72,80 €
	AFM66-PN0905-D080-A27-Z08	80	8	27	50	8	UYGUNDUR.	83,20 €
	AFM66-PN0905-D100-A32-Z10	100	10	32	50	8		104,30 €
	AFM66-PN0905-D125-B40-Z12	125	12	40	63	8		137,30 €
 67°	AFM67-PN1105-D050-A22-Z05	50	5	22	50	5		62,50 €
	AFM67-PN1105-D063-A22-Z06	63	6	22	50	5	PNEG 1105..	72,80 €
	AFM67-PN1105-D080-A27-Z08	80	8	27	50	5	ZCC UCUNA	83,20 €
	AFM67-PN1105-D100-B32-Z10	100	10	32	50	5	UYGUNDUR.	104,30 €
	AFM67-PN1105-D125-B40-Z12	125	12	40	63	5		137,30 €
	AFM67-PN1105-D160-C40-Z14	160	14	40	63	5		208,40 €
 75°	AFM75-AP16-D063-A22-Z04-H	63	4	22	40	6		51,90 €
	AFM75-AP16-D080-A27-Z05-H	80	5	27	50	6	AP.. 1604..	59,70 €
	AFM75-AP16-D100-A32-Z06-H	100	6	32	50	6	ISO	71,60 €
	AFM75-AP16-D125-B40-Z07	125	7	40	63	6		95,70 €

YÜZEY FREZELER

122/123

	TAKIM KODU	TAKIM ÖLÇÜLERİ (mm)					KESİCİ UÇ	FİYAT
		DC	ZEFP	DCON	LF	APMX		
 <p>75°</p>	AFM75-X012-D050-A22-Z04-H	50	4	22	40	-		51,30 €
	AFM75-X012-D063-A22-Z05-H	63	5	22	40	-	XO.. 1204..	56,90 €
	AFM75-X012-D080-A27-Z06-H	80	6	27	50	-	SC UCUNA	71,10 €
							UYGUNDUR.	
 <p>88°</p>	AFM88-SN1305-D050-A22-Z04	50	4	22	40	5		53,00 €
	AFM88-SN1305-D050-A22-Z05	50	5	22	40	5	SNMU 1305..	59,50 €
	AFM88-SN1305-D063-A22-Z05	63	5	22	40	5	KYCR UCUNA	61,60 €
	AFM88-SN1305-D063-A22-Z07	63	7	22	40	5	UYGUNDUR.	71,90 €
	AFM88-SN1305-D080-A27-Z06	80	6	27	50	5		71,90 €
	AFM88-SN1305-D080-A27-Z09	80	9	27	50	5		87,40 €
	AFM88-SN1305-D100-A32-Z07	100	7	32	50	5		80,20 €
	AFM88-SN1305-D100-A32-Z11	100	11	32	50	5		100,90 €
	AFM88-SN1305-D125-B40-Z13	125	13	40	63	5		129,80 €
 <p>88°</p>	AFM88-SN1306-D050-A22-Z05-H	50	5	22	40	5	SNGX 1306..	63,10 €
	AFM88-SN1306-D063-A22-Z06-H	63	6	22	40	5	TGTC UCUNA	72,00 €
	AFM88-SN1306-D080-A27-Z07-H	80	7	27	50	5	UYGUNDUR.	83,20 €
 <p>88°</p>	NEW AFM88C-SN1206-D050-A22-Z05-H	50	5	22	40	11.5	SN.. 1206..	61,30 €
	AFM88C-SN1206-D063-A22-Z06-H	63	6	22	40	11.5	ISO UCUNA	65,50 €
	AFM88C-SN1206-D080-A27-Z07-H	80	7	27	50	11.5	UYGUNDUR.	75,90 €
	AFM88C-SN1206-D100-A32-Z09-H	100	9	32	52	11.5		85,60 €
 <p>88°</p>	AFM88C-SN12..-D063-A22-Z06-H	63	6	22	40	11.5	SN.. 12..	72,00 €
	AFM88C-SN12..-D080-A27-Z07-H	80	7	27	50	11.5	ISO UCUNA	83,20 €
	AFM88C-SN12..-D100-A32-Z09-H	100	9	32	52	11.5	UYGUNDUR.	94,20 €

YÜZEY FREZELER



	TAKIM KODU	TAKIM ÖLÇÜLERİ (mm)					KESİCİ UÇ	FİYAT
		DC	ZEFP	DCON	LF	APMX		
 88°	AFM88C-SN12Z-D063-A22-Z06-H	63	6	22	40	11.5	SNEG 1205..	65,50 €
	AFM88C-SN12Z-D080-A27-Z07-H	80	7	27	50	11.5	ZCC UCUNA UYGUNDUR.	75,90 €
 89°	AFM89-SN1305I-D040-A16-Z04-H	40	4	16	40	10	SNMU 1305..	53,00 €
	AFM89-SN1305I-D050-A22-Z05-H	50	5	22	40	10	SNMU 1305..	63,00 €
	AFM89-SN1305I-D063-A22-Z06-H	63	6	22	40	10	OXMT 0507..	72,00 €
	AFM89-SN1305I-D063-A22-Z07-H	63	7	22	40	10	ISCR UCUNA	77,00 €
	AFM89-SN1305I-D080-A27-Z08-H	80	8	27	50	10	UYGUNDUR.	87,00 €
	AFM89-SN1305I-D100-A32-Z10-H	100	10	32	50	10		102,00 €
 90°	AFM90-AD10T3-D040-A16-Z06-H	40	6	16	40	10	ADMT 10T3..	47,00 €
	AFM90-AD10T3-D050-A22-Z07-H	50	7	22	40	10	WLTR UCUNA UYGUNDUR.	56,90 €
 90°	AFM90-AD1505-D040-A16-Z04-H	40	4	16	40	15		41,60 €
	AFM90-AD1505-D050-A22-Z05-H	50	5	22	40	15	AD.. 1505..	49,40 €
	AFM90-AD1505-D063-A22-Z06-H	63	6	22	40	15	ISCR UCUNA	57,30 €
	AFM90-AD1505-D080-A27-Z07-H	80	7	27	50	15	UYGUNDUR.	65,50 €
	AFM90-AD1505-D100-A32-Z08-H	100	8	32	50	15		79,30 €
	AFM90-AD1505-D125-B40-Z09	125	9	40	63	15		105,60 €
 90°	AFM90-AD1505D-D050-A22-Z05-H	50	5	22	40	14.3		49,40 €
	AFM90-AD1505D-D063-A27-Z06-H	63	6	27	50	14.3	ADKT 150508	57,30 €
	AFM90-AD1505D-D080-A27-Z08-H	80	8	27	50	14.3	DJT UCUNA	70,00 €
	AFM90-AD1505D-D100-A32-Z08-H	100	8	32	50	14.3	UYGUNDUR.	79,30 €
	AFM90-AD1505D-D125-B40-Z09	125	9	40	63	14.3		105,60 €
 90°	AFM90-AN11-D040-A16-Z04-H	40	4	16	40	11	ANGX 1105..	46,70 €
	AFM90-AN1506-D050-A22-Z04-H	50	4	22	40	14.5		51,70 €
	AFM90-AN1506-D063-A22-Z05-H	63	5	22	40	14.5	ANGX 1506..	60,30 €
	AFM90-AN1506-D080-A27-Z06-H	80	6	27	50	14.5	ZCC UCUNA	68,80 €
	AFM90-AN1506-D100-A32-Z08-H	100	8	32	50	14.5	UYGUNDUR.	82,50 €
	AFM90-AN1506-D125-B40-Z09	125	9	40	63	14.5		121,10 €
	AFM90-AN1506-D160-C40-Z10	160	10	40	63	14.5		156,50 €

YÜZEY FREZELER

124/125



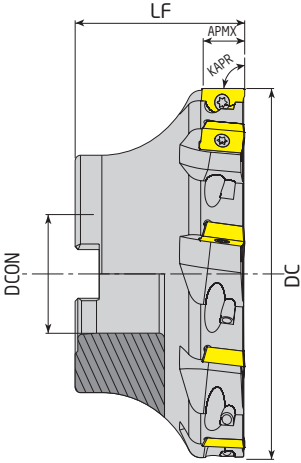

	TAKIM KODU	TAKIM ÖLÇÜLERİ (mm)					KESİCİ UÇ	FİYAT
		DC	ZEFP	DCON	LF	APMX		
 <p>90°</p>	AFM90-AN1607-D050-A22-Z04-H	50	4	22	40	15	AN.X 1607..	56,00 €
	AFM90-AN1607-D063-A22-Z06-H	63	6	22	40	15	TGTC UCUNA	76,10 €
	AFM90-AN1607-D080-A27-Z07-H	80	7	27	50	15	UYGUNDUR.	85,10 €
	AFM90-AN1607-D100-A32-Z08-H	100	8	32	50	15		94,00 €
	AFM90-AN1607-D125-B40-Z10	125	10	40	63	15		142,80 €
 <p>90°</p>	AFM90-AN12-D040-A16-Z04-H	40	4	16	40	12	ANKX 1205..	51,70 €
	AFM90-AN12-D050-A22-Z05-H	50	5	22	40	12	ISCR UCUNA	60,30 €
	AFM90-AN12-D063-A27-Z06-H	63	6	27	50	12	UYGUNDUR.	68,80 €
 <p>90°</p>	AFM90-AN1207-D040-A16-Z04-H	40	4	16	40	10	ANKX 1207..	51,70 €
	AFM90-AN1207-D050-A22-Z05-H	50	5	22	40	10	XTC-GSC UCUNA	60,30 €
	AFM90-AN1207-D063-A22-Z06-H	63	6	22	40	10	UYGUNDUR.	68,80 €
	AFM90-AN1607X-D050-A22-Z04-H	50	4	22	40	15	ANKX 1607..	56,10 €
	AFM90-AN1607X-D063-A22-Z06-H	63	6	22	40	15	XTC-GSC UCUNA	75,90 €
	AFM90-AN1607X-D080-A27-Z07-H	80	7	27	50	15	UYGUNDUR.	84,90 €
 <p>90°</p>	AFM90-A01236-D050-A22-Z05-H	50	5	22	40	12	AO.. 1236..	58,40 €
	AFM90-A01848-D050-A22-Z05-H	50	5	22	40	15	AO.. 1848..	58,40 €
	AFM90-A01848-D063-A22-Z06-H	63	6	22	40	15	MTSBH UCUNA	65,50 €
 <p>90°</p>	AFM90-AP1705-D050-A22-Z05-H	50	5	22	40	16	AP.. 1705..	49,40 €
	AFM90-AP1705-D063-A22-Z06-H	63	6	22	40	16	TGTC-LMNA UCUNA	57,30 €
	AFM90-AP1705-D080-A27-Z07-H	80	7	27	50	16	UYGUNDUR.	65,50 €
	AFM90-AP1705-D100-A32-Z08-H	100	8	32	50	16		79,30 €

YÜZEY FREZELER

	TAKIM KODU	TAKIM ÖLÇÜLERİ (mm)					KESİCİ UÇ	FİYAT
		DC	ZEFP	DCON	LF	APMX		
  90°	AFM90-AP10-D040-A16-Z05-H	40	5	16	40	10		37,70 €
	AFM90-AP10-D050-A22-Z06-H	50	6	22	40	10		45,70 €
	AFM90-AP10-D063-A22-Z07-H	63	7	22	40	10	AP. 1003..	51,90 €
	AFM90-AP10-D080-A27-Z08-H	80	8	27	50	10	ISO	59,70 €
	AFM90-AP10-D100-A32-Z09-H	100	9	32	50	10		71,60 €
	AFM90-AP16-D040-A16-Z04-H	40	4	16	40	16		37,70 €
	AFM90-AP16-D050-A22-Z05-H	50	5	22	40	16		45,70 €
	AFM90-AP16-D052-A22-Z05-H	52	5	22	40	16		62,50 €
	AFM90-AP16-D063-A22-Z06-H	63	6	22	40	16	AP. 1604..	51,90 €
	AFM90-AP16-D080-A27-Z07-H	80	7	27	50	16	ISO	59,70 €
	AFM90-AP16-D100-A32-Z08-H	100	8	32	50	16		71,60 €
	AFM90-AP16-D125-B40-Z09	125	9	40	63	16		95,70 €
	AFM90-AP16-D160-C40-Z10	160	10	40	63	16		119,40 €
	AFM90-AP16-D200-C60-Z12	200	12	60	63	16		189,70 €
	AFM90-AP16DJ-D050-A22-Z05-H	50	5	22	40	16	AP. 1604..	45,70 €
	AFM90-AP16DJ-D063-A22-Z06-H	63	6	22	40	16	DJT UCUNA	51,90 €
	AFM90-AP16DJ-D080-A27-Z07-H	80	7	27	50	16	UYGUNDUR.	59,70 €
	AFM90-AP16L-D050-A22-Z05-H	50	5	22	40	16	AP. 1604..	45,70 €
	AFM90-AP16L-D063-A22-Z06-H	63	6	22	40	16	LMN UCUNA	51,90 €
	AFM90-AP16L-D080-A27-Z07-H	80	7	27	50	16	UYGUNDUR.	59,70 €
	AFM90-AP16P-D040-A16-Z04-H	40	4	16	40	16		37,70 €
	AFM90-AP16P-D050-A22-Z05-H	50	5	22	40	16	AP. 1604..	45,70 €
	AFM90-AP16P-D063-A22-Z06-H	63	6	22	40	16	PLBT UCUNA	51,90 €
	AFM90-AP16P-D080-A27-Z07-H	80	7	27	50	16	UYGUNDUR.	59,70 €
	AFM90-AP16P-D100-A32-Z08-H	100	8	32	50	16		71,60 €
	AFM90-AP16A-D050-A22-Z05-H	50	5	22	40	15		45,70 €
	AFM90-AP16A-D063-A22-Z06-H	63	6	22	40	15	AP. 1604..	51,90 €
	AFM90-AP16A-D080-A27-Z07-H	80	7	27	50	15	ACHTK UCUNA	59,70 €
	AFM90-AP16A-D100-A32-Z08-H	100	8	32	50	15	UYGUNDUR.	71,60 €
	AFM90-AP16A-D125-B40-Z09	125	9	40	63	15		95,70 €
	YENİ AFM90-AP16Y-D040-A16-Z04-H	40	4	16	40	16	AP. 1604..	37,70 €
	YENİ AFM90-AP16Y-D050-A22-Z05-H	50	5	22	40	16	YG UCUNA	45,70 €
YENİ AFM90-AP16Y-D063-A22-Z06-H	63	6	22	40	16	UYGUNDUR.	51,90 €	
YENİ AFM90-AP16Y-D080-A27-Z07-H	80	7	27	50	16		59,70 €	
YENİ AFM90-AP16Y-D100-A32-Z08-H	100	8	32	50	16		71,60 €	
 90°	AFM90-AX1235-D040-A16-Z06-H	40	6	16	40	10	AX.T 1235..	64,20 €
	AFM90-AX1235-D050-A22-Z07-H	50	7	22	40	10	SMTM UCUNA	74,80 €
	AFM90-AX1235-D063-A22-Z08-H	63	8	22	40	10	UYGUNDUR.	84,30 €
	AFM90-AX1235-D080-A27-Z10-H	80	10	27	50	10		103,40 €
	AFM90-AX1705-D040-A16-Z04-H	40	4	16	40	14		43,80 €
	AFM90-AX1705-D050-A22-Z05-H	50	5	22	40	14	AX.T 1705..	52,80 €
	AFM90-AX1705-D063-A22-Z06-H	63	6	22	40	14	SMTM UCUNA	59,70 €
	AFM90-AX1705-D080-A27-Z07-H	80	7	27	50	14	UYGUNDUR.	68,80 €
	AFM90-AX1705-D100-A32-Z08-H	100	8	32	50	14		82,30 €

YÜZEY FREZELER

126/127

	TAKIM KODU	TAKIM ÖLÇÜLERİ (mm)					KESİCİ UÇ	FİYAT
		DC	ZEFP	DCON	LF	APMX		
 <p>90°</p>	YENI AFM90-BD11T3-D040-A16-Z04-H	40	4	16	40	10	BDMT 11T3..	45,20 €
	YENI AFM90-BD11T3-D040-A16-Z05-H	40	5	16	40	10	KYCR UCUNA	54,80 €
	YENI AFM90-BD11T3-D050-A22-Z05-H	50	5	22	40	10	UYGUNDUR.	54,80 €
	YENI AFM90-BD11T3-D063-A22-Z06-H	63	6	22	40	10		62,30 €
	YENI AFM90-BD1704-D050-A22-Z04-H	50	4	22	40	15.7	BDMT 1704..	48,40 €
	AFM90-BD1704-D050-A22-Z05-H	50	5	22	40	15.7	KYCR UCUNA	51,30 €
	AFM90-BD1704-D063-A22-Z06-H	63	6	22	40	15.7	UYGUNDUR.	56,90 €
	YENI AFM90-BD1704-D080-A27-Z06-H	80	6	27	50	15.7		62,60 €
	AFM90-BD1704-D080-A27-Z07-H	80	7	27	50	15.7		65,50 €
	YENI AFM90-BD1704-D100-A32-Z07-H	100	7	32	50	15.7		72,10 €
 <p>90°</p>	AFM90-LN1506X-D063-A22-Z06	63	6	22	40	7	LNMT 1506..	78,70 €
	AFM90-LN1506X-D080-A27-Z07	80	7	27	50	7	XTC-GSC UCUNA	89,70 €
	AFM90-LN1506X-D100-A32-Z08	100	8	32	50	7	UYGUNDUR.	116,60 €
 <p>90°</p>	AFM90-LN1106-D050-A22-Z05	50	5	22	40	10		68,30 €
	AFM90-LN1106-D063-A22-Z06	63	6	22	40	10		78,70 €
	AFM90-LN1106-D080-A27-Z08	80	8	27	50	10	LNMT 1106..	89,70 €
	AFM90L-LN1106-D080-A27-Z08	80	8	27	50	10	ISCR UCUNA	89,70 €
	AFM90-LN1106-D100-A32-Z09	100	9	32	50	10	UYGUNDUR.	113,80 €
	AFM90L-LN1106-D100-A32-Z09	100	9	32	50	10		113,80 €
	AFM90-LN1106-D125-B40-Z10	125	10	40	63	10		147,80 €
	AFM90-LN1306-D040-A16-Z04-H	40	4	16	40	12.5	T490	59,70 €
	AFM90-LN1306-D050-A22-Z05-H	50	5	22	40	12.5	LNMT 1306..	68,30 €
	AFM90-LN1306-D063-A22-Z06-H	63	6	22	40	12.5	ISCR UCUNA	78,70 €
	AFM90-LN1306-D080-A27-Z07-H	80	7	27	50	12.5	UYGUNDUR.	89,70 €
	AFM90-LN1306-D100-A32-Z08-H	100	8	32	50	12.5		116,60 €
	AFM90L-LN1506-D040-A16-Z04	40	4	16	40	14		59,70 €
	AFM90-LN1506-D040-A16-Z04	40	4	16	40	14	LNMT 1506..	59,70 €
	AFM90-LN1506-D050-A22-Z05	50	5	22	40	14	ISCR UCUNA	68,30 €
	AFM90-LN1506-D063-A22-Z06	63	6	22	40	14	UYGUNDUR.	78,70 €
	AFM90-LN1506-D080-A27-Z07	80	7	27	50	14		89,70 €
	AFM90-LN1607-D050-A22-Z03-H	50	3	22	40	16		68,30 €
	AFM90-LN1607-D063-A22-Z04-H	63	4	22	40	16	LNHT 1607..	78,70 €
	AFM90-LN1607-D080-A27-Z05-H	80	5	27	50	16	ISCR UCUNA	89,70 €
AFM90-LN1607-D100-A32-Z06-H	100	6	32	50	16	UYGUNDUR.	116,60 €	
 <p>90°</p>	AFM90-LN1306W-D050-A22-Z05-H	50	5	22	40	12	LNHU 1306..	68,30 €
	AFM90-LN1306W-D063-A22-Z06-H	63	6	22	40	12	WLTR UCUNA	78,70 €
	AFM90-LN1306W-D080-A27-Z07-H	80	7	27	50	12	UYGUNDUR.	89,70 €

YÜZEY FREZELER

	TAKIM KODU	TAKIM ÖLÇÜLERİ (mm)					KESİCİ UÇ	FİYAT
		DC	ZEFP	DCON	LF	APMX		
 90°	AFM90-LN1307-D050-A22-Z04-H	50	4	22	40	13	LNGX 1307..	72,00 €
	AFM90-LN1307-D063-A22-Z06-H	63	6	22	40	13	WLTR UCUNA	87,10 €
	AFM90-LN1307-D080-A27-Z07-H	80	7	27	50	13	UYGUNDUR.	114,90 €
	AFM90-LN1307-D100-A32-Z08-H	100	8	32	50	13		131,50 €
 90°	AFM90-LN15Z-D050-A22-Z04	50	4	22	40	15	LNKT 1506..	56,50 €
	AFM90-LN15Z-D063-A22-Z05	63	5	22	40	15	ZCC UCUNA	65,50 €
	AFM90-LN15Z-D080-A27-Z06	80	6	27	50	15	UYGUNDUR.	75,00 €
	AFM90-LN15Z-D100-A32-Z07	100	7	32	50	15		94,00 €
	AFM90-LN15Z-D125-B40-Z08	125	8	40	63	15		124,10 €
 90°	AFM90-LO08-D040-A16-Z06-H	40	6	16	40	2	LOEX 0804..	80,00 €
	AFM90-LO08-D050-A22-Z07-H	50	7	22	40	2	SC UCUNA	91,00 €
	AFM90-LO08-D063-A27-Z06-H	63	6	27	40	2	UYGUNDUR.	88,00 €
 90°	AFM90-LO1207-D040-A16-Z04-H	40	4	16	40	11	LOGU 1207..	59,70 €
	AFM90-LO1207-D050-A22-Z05-H	50	5	22	40	11	MTSBSH UCUNA	68,30 €
	AFM90-LO1207-D063-A22-Z05-H	63	5	22	40	11	UYGUNDUR.	77,90 €
 90°	AFM90-LN15T6-D050-A22-Z05-H	50	5	22	40	15.5	LNGU 15T6..	56,90 €
	AFM90-LN15T6-D063-A22-Z06-H	63	6	22	40	15.5	KNMTL UCUNA	65,50 €
	AFM90-LN15T6-D080-A27-Z07-H	80	7	27	50	15.5	UYGUNDUR.	73,90 €

YÜZEY FREZELER

128/129





	TAKIM KODU	TAKIM ÖLÇÜLERİ (mm)					KESİCİ UÇ	FİYAT	
		DC	ZEFP	DCON	LF	APMX			
 <p>90°</p>	AFM90-R290.12-D050-A22-Z04-H	50	4	22	40	10.7	R290-12T3..	47,80 €	
	AFM90-R290.12-D063-A22-Z05-H	63	5	22	40	10.7		55,80 €	
	AFM90-R290.12-D080-A27-Z07-H	80	7	27	50	10.7		SNDVK UCUNA	63,60 €
	AFM90-R290.12-D100-A32-Z09-H	100	9	32	50	10.7		UYGUNDUR.	79,30 €
	AFM90-R290.12-D125-B40-Z11	125	11	40	63	10.7			105,60 €
  <p>90°</p>	AFM90-R390.11-D040-A16-Z05-H	40	5	16	40	10	R390-11T3..	41,60 €	
	AFM90-R390.11-D050-A22-Z06-H	50	6	22	40	10	SNDVK UCUNA	49,40 €	
	AFM90-R390.11-D063-A22-Z07-H	63	7	22	40	10	UYGUNDUR.	57,30 €	
	AFM90-R390.11-D080-A27-Z09-H	80	9	27	50	10		71,60 €	
	AFM90-R390.17-D040-A16-Z04-H	40	4	16	40	15.4		41,60 €	
	AFM90-R390.17-D050-A22-Z05-H	50	5	22	40	15.4	R390-1704..	49,40 €	
	AFM90-R390.17-D063-A22-Z06-H	63	6	22	40	15.4	SNDVK UCUNA	57,30 €	
	AFM90-R390.17-D080-A27-Z07-H	80	7	27	50	15.4	UYGUNDUR.	65,50 €	
	AFM90-R390.17-D100-A32-Z08-H	100	8	32	50	15.4		79,30 €	
	AFM90-R390.17-D125-B40-Z09	125	9	40	63	15.4		105,60 €	
	AFM90-R390.18-D050-A22-Z04-H	50	4	22	40	15.4		49,40 €	
	AFM90-R390.18-D063-A22-Z05-H	63	5	22	40	15.4	R390-1806..	57,30 €	
	AFM90-R390.18-D080-A27-Z06-H	80	6	27	50	15.4	SNDVK UCUNA	65,50 €	
	AFM90-R390.18-D100-A32-Z07-H	100	7	32	50	15.4	UYGUNDUR.	79,30 €	
AFM90-R390.18-D125-B40-Z08	125	8	40	63	15.4		105,60 €		
 <p>90°</p>	YENI AFM90-490R08-D063-A22-Z06-H	63	6	22	40	5.5	490R-08T3..	73,10 €	
	AFM90-490R14-D050-A22-Z04-H	50	4	22	40	10		56,90 €	
	AFM90-490R14-D063-A22-Z05-H	63	5	22	40	10	490R-1404..	66,20 €	
	AFM90-490R14-D080-A27-Z07-H	80	7	27	50	10	SNDVK UCUNA	75,90 €	
	YENI AFM90-490R14-D100-A32-Z07-H	100	7	32	50	10	UYGUNDUR.	89,50 €	
	YENI AFM90-490R14-D125-B40-Z08	125	8	40	63	10		119,60 €	
	YENI AFM90-490R14-D160-C40-Z12	160	12	40	63	10		161,80 €	
	YENI AFM90-490R14-D200-C60-Z16	250	16	60	63	10		262,10 €	
 <p>90°</p>	AFM90-RT10-D040-A16-Z06-H	40	6	16	40	10	RT 1003..	42,70 €	
	AFM90-RT10-D050-A22-Z07-H	50	7	22	40	10	SFTY UCUNA	50,40 €	
	AFM90-RT10-D063-A22-Z09-H	63	9	22	50	10	UYGUNDUR.	61,60 €	

Kesme Hesabı : S 142

Sipariş Örneği: 1 ad. AFM90-R290.12-D050-A22-Z04-H







YÜZEY FREZELER

	TAKIM KODU	TAKIM ÖLÇÜLERİ (mm)					KESİCİ UÇ	FİYAT
		DC	ZEFP	DCON	LF	APMX		
 90°	AFM90S-SD1204-D050-A22-Z04-H	50	4	22	40	11		73,90 €
	AFM90S-SD1204-D063-A22-Z05-H	63	5	22	40	11	SDMT 1204..	88,10 €
	AFM90S-SD1204-D080-A27-Z06-H	80	6	27	50	11	DJT UCUNA	96,80 €
	AFM90S-SD1204-D100-A32-Z08-H	100	8	32	50	11	UYGUNDUR.	125,20 €
	AFM90S-SD1204-D125-B40-Z10	125	10	40	63	11		163,80 €
	AFM90S-SD1204-D160-C40-Z12	160	12	40	63	11		203,40 €
 90°	AFM90-SD09M4-D040-A16-Z04-H	40	4	16	40	9		47,80 €
	AFM90-SD09M4-D050-A22-Z05-H	50	5	22	40	9	SD.. 09M4..	51,90 €
	AFM90-SD09M4-D063-A22-Z06-H	63	6	22	40	9	KRLY UCUNA	59,70 €
	YENİ AFM90-SD09M4-D063-A27-Z06-H	63	6	27	40	9	UYGUNDUR.	59,70 €
	YENİ AFM90-SD09M4-D080-A27-Z07-H	80	7	27	50	9		69,40 €
	AFM90-SD1305-D050-A22-Z04-H	50	4	22	40	13		51,90 €
	AFM90-SD1305-D063-A22-Z05-H	63	5	22	40	13	SD.. 1305..	59,70 €
	AFM90-SD1305-D080-A27-Z06-H	80	6	27	50	13	KRLY UCUNA	69,40 €
	AFM90-SD1305-D100-A32-Z07-H	100	7	32	50	13	UYGUNDUR.	85,60 €
	AFM90-SD1305-D125-B40-Z08	125	8	40	63	13		113,40 €
AFM90-SD1305-D160-C40-Z10	160	10	40	63	13		139,70 €	
 90°	AFM90-SE09-D040-A16-Z04-H	40	4	16	40	6.7	SEET 09T3..	45,70 €
	AFM90-SE09-D050-A22-Z05-H	50	5	22	40	6.7	ZCC UCUNA	53,90 €
	AFM90-SE09-D063-A22-Z06-H	63	6	22	40	6.7	UYGUNDUR.	61,90 €
 90°	AFM90-SE12-D050-A22-Z04-H	50	4	22	40	12		47,80 €
	AFM90-SE12-D063-A22-Z05-H	63	5	22	40	12	SEET 1203..	55,80 €
	AFM90-SE12-D080-A27-Z07-H	80	7	27	50	12	ZCC UCUNA	63,60 €
	AFM90-SE12-D100-A32-Z09-H	100	9	32	50	12	UYGUNDUR.	79,30 €
	AFM90-SE12-D125-B40-Z11	125	11	40	63	12		105,60 €
 90°	AFM90-SP1004-D040-A16-Z04-H	40	4	16	40	9.4	SPMT 1004..	48,30 €
	YENİ AFM90-SP1004-D050-A22-Z04-H	50	4	22	40	9.4	XPMT 1004..	53,70 €
	AFM90-SP1004-D050-A22-Z06-H	50	6	22	40	9.4	QPMR 1004..	59,70 €
	YENİ AFM90-SP1004-D063-A22-Z05-H	63	5	22	40	9.4	QPMT 1004..	60,70 €
	YENİ AFM90-SP1004-D080-A27-Z07-H	80	7	27	50	9.4	ISCR UCUNA	75,80 €
	YENİ AFM90-SP1004-D100-A32-Z08-H	100	8	32	50	9.4	UYGUNDUR.	85,70 €

YÜZEY FREZELER



130/131

	TAKIM KODU	TAKIM ÖLÇÜLERİ (mm)					KESİCİ UÇ	FİYAT
		DC	ZEFP	DCON	LF	APMX		
 <p>90°</p>	AFM90-SP09T3-D040-A16-Z05-H	40	5	16	40	8,6	SPMT 09T3..	53,70 €
	AFM90-SP09T3-D050-A22-Z06-H	50	6	22	40	8,6	SNDVK UCUNA	57,60 €
	AFM90-SP09T3-D063-A22-Z07-H	63	7	22	40	8,6	UYGUNDUR.	65,40 €
	AFM90-SP09T3-D080-A27-Z08-H	80	8	27	50	8,6		75,50 €
 <p>90°</p>	AFM90-TN2207-D063-A22-Z04-H	63	4	22	40	15	TN.X 2207..	63,60 €
	AFM90-TN2207-D080-A27-Z05-H	80	5	27	50	15	TGTC UCUNA	77,80 €
	AFM90-TN2207-D100-B32-Z06	100	6	32	50	15	UYGUNDUR.	93,50 €
	AFM90-TN2207-D125-B40-Z08	125	8	40	63	15		123,90 €
 <p>90°</p>	AFM90-TP2205-D063-A22-Z04	63	4	22	40	18		59,70 €
	AFM90-TP2205-D080-A27-Z06	80	6	27	50	18	TPKT 2205..	69,40 €
	AFM90-TP2205-D100-A32-Z07	100	7	32	50	18	TGTC UCUNA	85,60 €
	AFM90-TP2205-D125-B40-Z08	125	8	40	63	18	UYGUNDUR.	115,90 €
	AFM90-TP2205-D160-C40-Z09	160	9	40	63	18		155,40 €
	AFM90-TP2205-D200-C60-Z12	200	12	60	63	18		219,00 €
 <p>90°</p>	AFM90-VC2205-D050-A22-Z03-H	50	5	22	55	15	VCKT 2205..	50,30 €
	AFM90-VC2205-D063-A22-Z04-H	63	6	22	55	15	KRLY UCUNA	57,10 €
	AFM90-VC2205-D066-A27-Z04-H	66	7	27	55	15	UYGUNDUR.	57,10 €
	AFM90-VC2205-D080-A27-Z05-H	80	8	27	60	15		65,70 €
 <p>90°</p>	AFM90-WNG04-D040-A16-Z04-H	40	4	16	40	4		63,20 €
	AFM90-WNG04-D040-A16-Z06-H	40	6	16	40	4	WNGU 0403..	69,20 €
	AFM90-WNG04-D050-A22-Z05-H	50	5	22	40	4	XTC-GSC UCUNA	65,90 €
	AFM90-WNG04-D050-A22-Z07-H	50	7	22	40	4	UYGUNDUR.	71,90 €
	AFM90-WNG04-D063-A22-Z06-H	63	6	22	40	4		71,10 €
	AFM90-WNG08-D050-A22-Z05-H	50	5	22	40	7,5	WNGU 0806..	65,90 €
	AFM90-WNG08-D063-A22-Z06-H	63	6	22	40	7,5	XTC-GSC UCUNA	71,10 €
	AFM90-WNG08-D080-A27-Z07-H	80	7	27	50	7,5	UYGUNDUR.	74,10 €

YÜZEY VE KOPYA FREZELER

	TAKIM KODU	TAKIM ÖLÇÜLERİ (mm)					KESİCİ UÇ	FİYAT
		DCX	ZEFP	DCON	LF	APMX		
 90°	AFM90-WN0604Z-D040-A16-Z04-H	40	4	16	40	5.7	WNHU 0604..	63,20 €
	AFM90-WN0604Z-D050-A22-Z05-H	50	5	22	40	5.7	ZCC UCUNA	65,90 €
	AFM90-WN0604Z-D063-A22-Z06-H	63	6	22	40	5.7	UYGUNDUR.	71,10 €
	AFM90-WN0604Z-D080-A27-Z07-H	80	7	27	50	5.7		76,40 €
	AFM90-WN0604Z-D100-A32-Z09-H	100	9	32	50	5.7		96,90 €
	AFM90-WN0806Z-D050-A22-Z04-H	50	4	22	40	7.7		63,20 €
	AFM90-WN0806Z-D063-A22-Z05-H	63	5	22	40	7.7	WNHU 0806..	65,90 €
	AFM90-WN0806Z-D080-A27-Z06-H	80	6	27	50	7.7	ZCC UCUNA	68,50 €
	AFM90-WN0806Z-D100-A32-Z08-H	100	8	32	50	7.7	UYGUNDUR.	86,90 €
	AFM90-WN0806Z-D125-B40-Z10	125	10	40	63	7.7		113,30 €
AFM90-WN0806Z-D160-C40-Z12	160	12	40	63	7.7		158,00 €	
 90°	AFM90-WN0806-D050-A16-Z04-H	50	4	16	40	8	WNMX 080608	70,70 €
	AFM90-WN0806-D063-A22-Z05-H	63	5	22	40	8	KYCR-JD UCUNA	84,50 €
	AFM90-WN0806-D080-A27-Z07-H	80	7	27	50	8	UYGUNDUR.	101,90 €
 90°	AFM90-XN0403-D040-A16-Z05-H	40	5	16	40	4	XNEX 0403..	50,00 €
	AFM90-XN0806-D050-A22-Z04-H	50	4	22	40	7.5	XNEX 0806..	50,00 €
	AFM90-XN0806-D063-A22-Z05-H	63	5	22	40	7.5	SC UCUNA	56,90 €
	AFM90-XN0806-D080-A27-Z07-H	80	7	27	50	7.5	UYGUNDUR.	73,90 €
	AFM90-XN0806-D100-A32-Z08-H	100	8	32	50	7.5		85,30 €
 90°	AFM90-X012-D040-A16-Z05-H	40	5	16	40	11		37,70 €
	AFM90-X012-D050-A22-Z07-H	50	7	22	40	11	XO.. 1204..	49,40 €
	AFM90-X012-D063-A22-Z08-H	63	8	22	40	11	SC UCUNA	55,80 €
	AFM90-X012-D080-A27-Z10-H	80	10	27	50	11	UYGUNDUR.	68,10 €
	AFM90-X012-D100-A32-Z12-H	100	12	32	50	11		85,30 €
 90°	AFM90-3P1004-D040-A16-Z05-H	40	5	16	40	7	3PKT 1004..	62,60 €
	AFM90-3P1004-D050-A22-Z06-H	50	6	22	40	7	TGTC	68,80 €
	AFM90-3P1505-D050-A22-Z04-H	50	4	22	40	11		65,70 €
	AFM90-3P1505-D050-A22-Z05-H	50	5	22	40	11		68,30 €
	AFM90-3P1505-D063-A22-Z04-H	63	4	22	40	11	3PKT 1505..	68,80 €
	AFM90-3P1505-D063-A22-Z06-H	63	6	22	40	11	TGTC UCUNA	87,60 €
	AFM90-3P1505-D080-A27-Z07-H	80	7	27	50	11	UYGUNDUR.	105,10 €
	AFM90-3P1505-D100-A32-Z08-H	100	8	32	50	11		126,10 €
	AFM90-3P1505-D125-B40-Z10	125	10	40	63	11		159,00 €

YÜZEY VE KOPYA FREZELER

	TAKIM KODU	TAKIM ÖLÇÜLERİ (mm)					KESİCİ UÇ	FİYAT
		DCX	ZEFP	DCON	LF	APMX		
	AFMR-RY10-D040-A16-Z04-H	40	4	16	40	5	RYMX 1004..	48,60 €
	AFMR-RY10-D040-A16-Z05-H	40	5	16	40	5	TGTC UCUNA	53,10 €
	AFMR-RY10-D050-A22-Z05-H	50	5	22	50	5	UYGUNDUR.	57,10 €
	AFMR-RY10-D063-A22-Z06-H	63	6	22	50	5		65,70 €
	AFMR-RY12-D040-A16-Z04-H	40	4	16	40	6		48,60 €
	AFMR-RY12-D050-A22-Z05-H	50	5	22	50	6	RYMX 1205..	57,10 €
	AFMR-RY12-D052-A22-Z05-H	52	5	22	50	6	TGTC UCUNA	57,10 €
	AFMR-RY12-D063-A22-Z06-H	63	6	22	50	6	UYGUNDUR.	65,70 €
	AFMR-RY12-D080-A27-Z06-H	80	6	27	50	6		69,80 €
	AFMR-RY12-D100-A32-Z07-H	100	7	32	50	6		87,90 €
	AFMR-QP10T3-D040-A16-Z04-H	40	4	16	40	5	QP.. 10T3..	50,40 €
	AFMR-QP10T3-D050-A22-Z05-H	50	5	22	40	5	SMTM UCUNA	59,70 €
	AFMR-QP10T3-D063-A22-Z06-H	63	6	22	40	5	UYGUNDUR.	68,80 €
	AFMR-QP1204-D050-A22-Z04-H	50	4	22	40	6	QP.. 1204..	62,50 €
	AFMR-QP1204-D063-A22-Z05-H	63	5	22	40	6	SMTM UCUNA	68,80 €
							UYGUNDUR.	

Kesme Hesabı : S 142

Sipariş Örneği: 1 ad. AFMR-RY10-D040-A16-Z04-H



YÜZEY VE KOPYA FREZELER

134/135

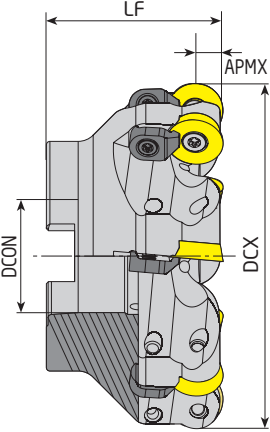
	TAKIM KODU	TAKIM ÖLÇÜLERİ (mm)					KESİCİ UÇ	FİYAT
		DCX	ZEFP	DCON	LF	APMX		
 	AFMR-RD0702-D050-A22-Z06-H	50	6	22	40	3,5	RD.. 0702..	58,60 €
	AFMR-RD0803-D050-A22-Z05-H	50	5	22	40	4	RD.. 0803..	58,60 €
	AFMRC-RD1003-D040-A16-Z04-H	40	4	16	40	5		44,20 €
	AFMRC-RD1003-D050-A22-Z05-H	50	5	22	40	5	RD.. 1003..	51,90 €
	AFMRC-RD1003-D052-A22-Z05	52	5	22	50	5	ISO	51,90 €
	AFMRC-RD1003-D063-A22-Z06-H	63	6	22	40	5		59,70 €
	AFMRC-RD1003-D080-A27-Z07-H	80	7	27	50	5		69,40 €
	AFMRC-RD1003-D100-A32-Z08-H	100	8	32	50	5		85,60 €
	AFMRC-RD10T3-D050-A22-Z05-H	50	5	22	50	5	RD.. 10T3..	51,90 €
	AFMRC-RD10T3-D063-A22-Z06-H	63	6	22	50	5	ISO	59,70 €
	AFMRC-RD12T3-D040-A16-Z04-H	40	4	16	40	6		44,20 €
	AFMRC-RD12T3-D050-A22-Z05-H	50	5	22	40	6		51,90 €
	AFMRC-RD12T3-D052-A22-Z05-H	52	5	22	40	6	RD.. 12T3..	51,90 €
	AFMRC-RD12T3-D063-A22-Z06-H	63	6	22	40	6	ISO	59,70 €
	AFMRC-RD12T3-D080-A27-Z07-H	80	7	27	50	6		69,40 €
	AFMRC-RD12T3-D100-A32-Z08-H	100	8	32	50	6		85,60 €
	AFMRC-RD12T3-D125-B40-Z09	125	9	40	63	6		113,40 €
	AFMRC-RD1204-D040-A16-Z04-H	40	4	16	40	6		44,20 €
	AFMRC-RD1204-D050-A22-Z05-H	50	5	22	40	6		51,90 €
	AFMRC-RD1204-D052-A22-Z05-H	52	5	22	40	6	RD.. 1204..	51,90 €
	AFMRC-RD1204-D063-A22-Z06-H	63	6	22	40	6	ISO	59,70 €
	AFMRC-RD1204-D080-A27-Z07-H	80	7	27	50	6		69,40 €
	AFMRC-RD1204-D100-A32-Z07-H	100	7	32	50	6		79,30 €
	AFMRC-RD1204-D100-A32-Z08-H	100	8	32	50	6		85,60 €
	AFMRC-RD1604-D050-A22-Z04-H	50	4	22	40	8		55,80 €
	AFMRC-RD1604-D052-A22-Z04-H	52	4	22	50	8		55,80 €
	AFMRC-RD1604-D063-A22-Z05-H	63	5	22	40	8		63,60 €
	AFMRC-RD1604-D066-A22-Z05-H	66	5	22	50	8	RD.. 1604..	63,60 €
	AFMRC-RD1604-D066-A27-Z05-H	66	5	27	50	8	ISO	63,60 €
	AFMRC-RD1604-D080-A27-Z06-H	80	6	27	50	8		79,30 €
AFMRC-RD1604-D100-A32-Z07-H	100	7	32	50	8		91,60 €	
AFMRC-RD1604-D125-B40-Z07	125	7	40	63	8		119,00 €	
AFMRC-RD1604-D160-C40-Z08	160	8	40	63	8		162,30 €	

0°

YÜZEY FREZELER

	TAKIM KODU	TAKIM ÖLÇÜLERİ (mm)					KESİCİ UÇ	FİYAT
		DC	ZEFP	DCON	LF	APMX		
	AFM43C-OF07-D063-A22-Z04	63	4	22	40	5		59,70 €
	AFM43C-OF07-D080-A27-Z05	80	5	27	50	5	OF.. 0704..	69,40 €
	AFM43C-OF07-D100-A32-Z06	100	6	32	50	5	ISO	89,70 €
	AFM43C-OF07-D125-B40-Z08	125	8	40	63	5		119,40 €
	AFM43C-OF07-D160-C40-Z09	160	9	40	63	5		142,00 €

43°

YÜZEY FREZELER







	TAKIM KODU	TAKIM ÖLÇÜLERİ (mm)					KESİCİ UÇ	FİYAT
		DC	ZEFP	DCON	LF	APMX		
 45°	AFM45C-HN0905-D063-A22-Z07	63	7	22	40	4.5		68,10 €
	AFM45C-HN0905-D080-A27-Z09	80	9	27	50	4.5	HN.. 0905..	79,30 €
	AFM45C-HN0905-D100-A32-Z11	100	11	32	50	4.5	WDA-KNMTL	91,60 €
	AFM45C-HN0905-D125-B40-Z13	125	13	40	63	4.5	UCUNA	111,20 €
	AFM45CL-HN0905-D125-B40-Z10	125	10	40	63	4.5	UYGUNDUR.	111,20 €
	AFM45C-HN0905-D160-C40-Z15	160	15	40	63	4.5		159,10 €
 45°	AFM45C-XN0806-D063-A22-Z05	63	5	22	50	4.5		59,50 €
	AFM45C-XN0806-D080-A27-Z06	80	6	27	50	4.5	XNMU 0806..	65,70 €
	AFM45C-XN0806-D100-A32-Z08	100	8	32	50	4.5	DJT UCUNA	78,20 €
	AFM45C-XN0806-D125-B40-Z08	125	8	40	63	4.5	UYGUNDUR.	93,90 €
	AFM45C-XN0806-D160-C40-Z10	160	10	40	63	4.5		140,80 €
	AFM45C-XN0806-D200-C60-Z12	200	12	60	63	4.5		203,40 €
 75°	AFM75C-SP12-D050-A22-Z04	50	4	22	42	8		44,20 €
	AFM75C-SP12-D063-A22-Z05	63	5	22	40	8		49,40 €
	AFM75C-SP12-D080-A27-Z06	80	6	27	50	8		59,70 €
	AFM75C-SP12-D100-A32-Z07	100	7	32	50	8	SPKN 1203..	71,60 €
	AFM75C-SP12-D125-B40-Z08	125	8	40	63	8	ISO	95,70 €
	AFM75C-SP12-D160-C40-Z09	160	9	40	63	8		119,40 €
	AFM75C-SP12-D200-C60-Z12	200	12	60	63	8		169,00 €
 88°	AFM88C-SN1204-D050-A22-Z05	50	5	22	40	11		68,50 €
	AFM88C-SN1204-D063-A22-Z06	63	6	22	40	11	SN.. 1204..	85,40 €
	AFM88C-SN1204-D080-A27-Z07	80	7	27	50	11	UNIN-NT-KYCR	113,90 €
	AFM88C-SN1204-D100-A32-Z08	100	8	32	50	11	UCUNA UYGUNDUR.	125,30 €
	AFM88C-SN1204-D125-B40-Z11	125	11	40	63	11		186,60 €
 90°	AFM90C-TP16-D050-A22-Z04	50	4	22	40	12		44,20 €
	AFM90C-TP16-D063-A22-Z06	63	6	22	45	12		49,40 €
	AFM90C-TP16-D080-A27-Z07	80	7	27	50	12	TP.. 1603..	59,70 €
	AFM90C-TP16-D100-A32-Z08	100	8	32	50	12	ISO	71,60 €
	AFM90C-TP16-D125-B40-Z08	125	8	40	63	12		95,70 €
	AFM90C-TP22-D063-A22-Z05	63	5	22	45	18		49,40 €
	AFM90C-TP22-D080-A27-Z06	80	6	27	50	18		59,70 €
	AFM90C-TP22-D100-A32-Z07	100	7	32	50	18	TP.. 2204..	71,60 €
	AFM90C-TP22-D125-B40-Z08	125	8	40	63	18	ISO	95,70 €
	AFM90C-TP22-D160-C40-Z09	160	9	40	63	18		119,40 €
	AFM90C-TP22-D200-C60-Z12	200	12	60	63	18		169,00 €
	AFM90C-TP22-D250-C60-Z15	250	15	60	63	18		238,40 €
	AFM90C-TP22-D315-D60-Z18	315	18	60	63	18		385,80 €

HIZLI İLERLEMELİ FREZELER

136/137

	TAKIM KODU	TAKIM ÖLÇÜLERİ (mm)					KESİCİ UÇ	FİYAT
		DCX	ZEFP	DCON	LF	APMX		
	YENİ AHFM-BL0603-D040-A16-Z06-H	40	6	16	40	1	BLMP 0603..	50,60 €
	YENİ AHFM-BL0603-D050-A22-Z07-H	50	7	22	40	1		60,20 €
	AHFM-BL0904-D040-A16-Z05-H	40	5	16	40	2	BLMP 0904..	43,70 €
	AHFM-BL0904-D050-A22-Z06-H	50	6	22	50	2	TGTC UCUNA	50,20 €
	AHFM-BL0904-D063-A22-Z05-H	63	5	22	50	2	UYGUNDUR.	62,50 €
	AHFM-BL0904-D063-A22-Z07-H	63	7	22	50	2		85,30 €
	AHFM-BL1205-D050-A22-Z03-H	50	3	22	40	2	BLMP 1205..	77,80 €
	AHFM-BL1205-D063-A22-Z04-H	63	4	22	40	2	TGTC UCUNA	87,50 €
	AHFM-BL1205-D080-A27-Z05-H	80	5	27	50	2	UYGUNDUR.	103,20 €
	AHFM-EN1004-D050-A22-Z05-H	50	5	22	50	1	ENMU 1004..	50,20 €
	AHFM-EN1004-D050-A22-Z06-H	50	6	22	50	1	DJT UCUNA	55,40 €
	AHFM-EN1004-D052-A22-Z06-H	52	6	22	50	1	UYGUNDUR.	55,40 €
	AHFM-EN1004-D063-A22-Z06-H	63	6	22	50	1		58,20 €
	AHFM-EP1003-D050-A22-Z08-H	50	8	22	40	1	EP. 1003..	64,20 €
	AHFM-EP1003-D063-A22-Z08-H	63	8	22	40	1	ZPMT 1003..	67,20 €
							YPHW 1003..	
	AHFM-L003-D040-A16-Z06-H	40	6	16	40	1	LOGU 0303..	61,40 €
	AHFM-L003-D050-A22-Z07-H	50	7	22	40	1	KYCR UCUNA	72,20 €
	AHFM-L003-D063-A22-Z09-H	63	9	22	40	1	UYGUNDUR.	89,40 €
	AHFM-LN0303-D040-A16-Z06-H	40	6	16	40	12	LNMU 0303..	55,40 €
	AHFM-LN0303-D050-A22-Z07-H	50	7	22	50	12	TNGLY UCUNA	65,00 €
	AHFM-LN0303-D063-A22-Z09-H	63	9	22	50	12	UYGUNDUR.	80,50 €

HIZLI İLERLEMELİ FREZELER

	TAKIM KODU	TAKIM ÖLÇÜLERİ (mm)					KESİCİ UÇ	FİYAT
		DCX	ZEFP	DCON	LF	APMX		
	AHFM-JD1003-D040-A16-Z06-H	40	6	16	40	9	JDMT 1003..	72,00 €
	AHFM-JD1003-D063-A22-Z08-H	63	8	22	40	9	MTSBH UCUNA UYGUNDUR.	90,90 €
	AHFMC-JD1204-D052-A22-Z03-H	52	3	22	50	1.5	JDMW 1204..	59,70 €
	AHFMC-JD1204-D052-A22-Z04-H	52	4	22	50	1.5		68,30 €
	AHFMC-JD1204-D063-A22-Z05-H	63	5	22	50	1.5	MTSBH UCUNA	78,40 €
	AHFMC-JD1204-D080-A27-Z06-H	80	6	27	50	1.5	UYGUNDUR.	90,90 €
	AHFMC-JD1204-D100-A32-Z07-H	100	7	32	50	1.5		106,90 €
	AHFMC-JD1405-D052-A22-Z03-H	52	3	22	40	2	JDMW 1405..	68,30 €
	AHFMC-JD1405-D063-A22-Z04-H	63	4	22	40	2	MTSBH UCUNA UYGUNDUR.	79,70 €
	AHFMC-SD1204-D050-A22-Z04-H	50	4	22	40	1.8	SD.. 1204..	59,10 €
	AHFMC-SD1204-D063-A22-Z05-H	63	5	22	40	1.8	ZCC UCUNA	68,30 €
	AHFMC-SD1204-D080-A27-Z06-H	80	6	27	50	1.8	UYGUNDUR.	94,00 €
	AHFMC-SD1204-D100-A32-Z08-H	100	8	32	50	1.8		113,80 €
	AHFM-SD1205-D052-A22-Z04-H	52	4	22	50	2	SD.. 1205..	70,00 €
	AHFM-SD1205-D052-A22-Z05-H	52	5	22	50	2	HTCH UCUNA	75,90 €
	AHFM-SD1205-D066-A22-Z05-H	66	5	22	50	2	UYGUNDUR.	85,30 €
	AHFM-SD1205-D066-A22-Z06-H	66	6	22	50	2		90,70 €
	AHFM-SD1205-D080-A27-Z06-H	80	6	27	70	2		98,70 €
	AHFM-SO1004-D050-A22-Z05-H	50	5	22	50	1.5	SOMT 1004..	65,90 €
	AHFM-SO1004-D063-A22-Z06-H	63	6	22	50	1.5	KYCR UCUNA	75,00 €
	AHFM-SO1004-D080-A27-Z07-H	80	7	27	63	1.5	UYGUNDUR.	93,10 €
	AHFM-SP1004-D050-A22-Z05-H	50	5	22	50	9.4	SPNW 1004..	67,90 €
	AHFM-SP1004-D052-A22-Z05-H	52	5	22	50	9.4	DJT UCUNA	67,90 €
	AHFM-SP1004-D063-A22-Z06-H	63	6	22	50	9.4	UYGUNDUR.	75,00 €

HIZLI İLERLEMELİ FREZELER

138/139

	TAKIM KODU	TAKIM ÖLÇÜLERİ (mm)					KESİCİ UÇ	FİYAT
		DCX	ZEFP	DCON	LF	APMX		
	AHFMC-WD06T3D-D042-A16-Z04-H	42	4	16	45	1.5	WD.W 06T3..	62,10 €
	AHFMC-WD06T3D-D050-A22-Z05-H	50	5	22	50	1.5	DJT UCUNA	65,50 €
	AHFMC-WD06T3D-D052-A22-Z05-H	52	5	22	50	1.5	UYGUNDUR.	67,50 €
	AHFMC-WD0805D-D052-A22-Z04-H	52	4	22	50	2		65,50 €
	AHFMC-WD0805D-D063-A22-Z05-H	63	5	22	50	2	WD.W 0805..	74,10 €
	AHFMC-WD0805D-D063-A27-Z05-H	63	5	27	50	2	DJT UCUNA	74,10 €
	AHFMC-WD0805D-D066-A27-Z05-H	66	5	27	50	2	UYGUNDUR.	78,40 €
	AHFMC-WD0805D-D080-A27-Z05	80	5	27	50	2		89,70 €
	AHFMC-WD0805D-D100-A32-Z06	100	6	32	50	2		113,80 €
	AHFMC-WD10X6D-D125-B40-Z06	125	6	40	63	2.5	WD.W 10X6..	125,20 €
AHFMC-WD10X6D-D160-C40-Z07	160	7	40	63	2.5	DJT UCUNA	156,50 €	
						UYGUNDUR.		
	AHFMC-WD0804-D040-A16-Z04-H	40	4	16	40	-	WDMT 0804..	64,40 €
	AHFMC-WD0804-D050-A22-Z04-H	50	4	22	50	-	SMTM	71,10 €
	AHFMC-WD1205-D050-A22-Z04-H	50	4	22	50	-	WDMT 1205..	66,20 €
	AHFMC-WD1205-D052-A22-Z04-H	52	4	22	50	-	SMTM UCUNA	66,20 €
	AHFMC-WD1205-D063-A22-Z05-H	63	5	22	50	-	UYGUNDUR.	78,40 €
	AHFMC-WD1205-D080-A27-Z06-H	80	6	27	63	-		89,70 €
	AHFM-WN0907-D050-A22-Z04-H	50	4	22	50	3	WNMU 0907..	68,90 €
	AHFM-WN0907-D052-A22-Z04-H	52	4	22	50	3	DJT UCUNA	65,50 €
	AHFM-WN0907-D063-A22-Z05-H	63	5	22	50	3	UYGUNDUR.	74,10 €
	AHFM-WN0907-D066-A27-Z05-H	66	5	27	50	3		78,40 €
	AHFM-WN0907-D080-A27-Z06-H	80	6	27	50	3		98,30 €
	AHFM-WN0907-D100-A32-Z07-H	100	7	32	50	3		117,90 €
	AHFM-WN09T3-D040-A16-Z04-H	40	4	16	40	1.5		53,90 €
	AHFML-WN09T3-D040-A16-Z04-H	40	4	16	40	1.5	WNMX 09T3..	53,90 €
	AHFM-WN09T3-D050-A22-Z05-H	50	5	22	40	1.5	KRLY UCUNA	64,70 €
	AHFML-WN09T3-D050-A22-Z05-H	50	5	22	40	1.5	UYGUNDUR.	64,70 €
	AHFM-WN09T3-D063-A22-Z06-H	63	6	22	40	1.5		72,60 €

T KANAL FREZELER

	TAKIM KODU	ZEFP		TAKIM ÖLÇÜLERİ (mm)						KESİCİ UÇ	FİYAT
		TOPLAM	ETKİLİ	DC	CW	DCON	LF	DN	LH		
  90°	ATSM90-CC06-D17X8-W16-L85-Z02	2	1	17	8	16	85	10	16		47,80 €
	ATSM90-CC06-D28X8-W20-L66-Z04	4	2	32	8	25	100	16	23		61,90 €
	ATSM90-CC06-D32X8-W25-L100-Z04	4	2	28	8	20	66	14	15,5		61,90 €
	ATSM90-CC06-D45.5X8-W25-L100-Z06	6	3	45.5	8	25	100	12	30		94,00 €
	ATSM90-CC06-D63X8-W32-L125-Z08	8	4	63	8	32	125	31.5	30		119,40 €
	ATSM90-CC06-D18X9-W16-L90-Z02	2	1	18	9	16	90	10	16	CC.. 0602..	47,80 €
	ATSM90-CC06-D20X9-W16-L85-Z04	4	2	20	9	16	85	10	16	ISO	49,40 €
	ATSM90-CC06-D23X10-W20-L90-Z04	4	2	23	10	20	90	12	25		51,90 €
	ATSM90-CC06-D32X10-W25-L100-Z04	4	2	32	10	25	100	16	25		61,90 €
	ATSM90-CC06-D45X10-W32-L120-Z06	6	3	45	10	32	120	20	25		81,70 €
	ATSM90-CC06-D25X11-W25-L100-Z04	4	2	25	11	25	100	13	20		51,90 €
	ATSM90-CC09-D30X12-W25-L100-Z04	4	2	30	12	25	100	16	25		57,30 €
	ATSM90-CC09-D32X12-W25-L100-Z02	2	1	32	12	25	100	16	25		53,90 €
	ATSM90-CC09-D32X12-W25-L100-Z04	4	2	32	12	25	100	16	25	CC.. 09T3..	61,90 €
	ATSM90-CC09-D32X14-W25-L100-Z04	4	2	32	14	25	100	16	25	ISO	61,90 €
	ATSM90-CC09-D37X16-W32-L120-Z04	4	2	37	16	32	120	17	30		68,10 €
	ATSM90-CC09-D42X17-W32-L120-Z04	4	2	42	17	32	120	19	30		71,60 €
	ATSM90-CC09-D40X17-W32-L120-Z04-H	4	2	40	17	32	120	19	30		71,60 €
ATSM90-CC12-D47X20-W32-L120-Z04	4	2	47	20	32	120	25	45		81,70 €	
ATSM90-CC12-D52X21-W32-L120-Z04	4	2	52	21	32	120	25	45	CC.. 1204..	85,60 €	
ATSM90-CC12-D50X22-W32-L120-Z04	4	2	50	22	32	120	25	45	ISO	81,70 €	
ATSM90-CC12-D55X22-W32-L120-Z04	4	2	55	22	32	120	25	45		91,60 €	
 90°	ATSM90-SP..05-D22.5X5-W25-L100-Z04	4	2	22.5	5	25	100	12	25	SPMG 050204	78,40 €
	ATSM90-SP..05-D30X5-W25-L100-Z04	4	2	30	5	25	100	10	25	TGTC UCUNA UYGUN.	109,70 €
	ATSM90-SPGT0502-D63X6-W32-L125-Z10	10	5	63	6	32	125	31	30	SPGT 050204	142,20 €
	ATSM90-SPGT0904-D32X14-W32-L120-Z04-H	4	2	32	14	32	120	17.5	30	SPGT 090408	68,10 €
	ATSM90-SPGT0904-D37X16-W32-L120-Z04-H	4	2	37	16	32	120	21	40	ZCC UCUNA UYGUN.	68,10 €
	ATSM90-SPGT0904-D42X17-W32-L120-Z04-H	4	2	42	17	32	120	21	40		71,60 €
	ATSM90-SPGT1104-D47X20-W32-L120-Z04-H	4	2	47	20	32	120	24	45	SPGT 110408	81,70 €
	ATSM90-SP..06-D80X7-W32-L120-Z10	10	5	80	7	32	120	32	30	SPMG 060204	262,70 €
									TGTC UCUNA UYGUN.		
	TAKIM KODU	TAKIM ÖLÇÜLERİ (mm)						KESİCİ UÇ	FİYAT		
		ZEFP	DCX	CW	DCON	LF	DN			LH	
  10°	ATSMR-RD0702-D17-W16-L90-Z02	2	17	7	16	90	10	12	RD.. 0702..	43,10 €	
	ATSMR-RD0702-D25-W16-L90-Z03	3	25	7	16	90	15	12	ISO	50,20 €	
	ATSMR-RD0702-D35-W25-L100-Z05	5	35	7	25	100	20	20		60,30 €	
	ATSMR-RD1003-D21-W25-L100-Z02	2	21	10	25	100	12	20	RD.. 1003..	44,80 €	
	ATSMR-RD1003-D80-W32-L165-Z06-H	6	80	10	32	165	30	31.5		256,00 €	
	ATSMR-RD12T3-D25-W25-L100-Z02	2	25	12	25	100	15	24	RD.. 12T3..	46,60 €	
	ATSMR-RD12T3-D80-W32-L165-Z06-H	6	80	12	32	165	30	31.5		256,00 €	
	ATSMR-RD1604-D34-W32-L110-Z02	2	34	16	32	110	20	30	RD.. 1604..	48,10 €	
									ISO		

Kesme Hesabı : S 142



T Kanal Freze Kullanma Kılavuzu : S 143

Sipariş Örneği: 1 ad. ATSM90-CC06-D17X8-W16-L85-Z02



DİSK FREZELER

140/141

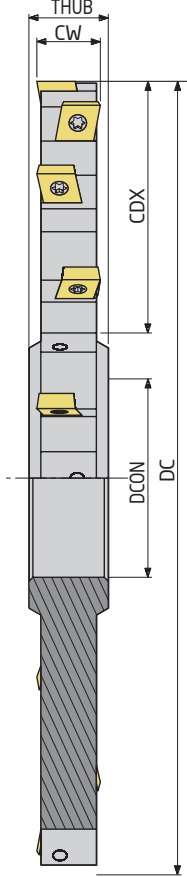
	TAKIM KODU	ZEFP		TAKIM ÖLÇÜLERİ (mm)					KESİCİ UÇ	FİYAT
		TOPLAM	ETKİLİ	DC	CW	CDX	DCON	THUB		
 <p>90°</p>	ASDM-SPGT05-D80x6-d27-Z10	10	5	80	6	17	27	10	SPGT 0502..	88,80 €
	ASDM-SPGT05-D100x6-d32-Z12	12	6	100	6	25	32	10	ZCC UCUNA	104,50 €
	ASDM-SPGT05-D125x6-d40-Z14	14	7	125	6	35	40	10	UYGUNDUR.	156,90 €
	ASDM-SPGT05-D160x6-d40-Z18	18	9	160	6	52	40	10		209,30 €
	ASDM-SPGT06-D80x7-d27-Z10	10	5	80	7	17	27	11		88,80 €
	ASDM-SPGT06-D100x7-d32-Z12	12	6	100	7	25	32	11	SPGT 0602..	104,50 €
	ASDM-SPGT06-D125x7-d40-Z14	14	7	125	7	35	40	11	ZCC UCUNA	156,90 €
	ASDM-SPGT06-D160x7-d40-Z16	16	8	160	7	52	40	11	UYGUNDUR.	209,30 €
	ASDM-SPGT06-D200x7-d40-Z18	18	9	200	7	70	40	11		261,60 €
ASDM-SPGT07-D100x10-d32-Z12	12	6	100	10	25	32	11	SPGT 07T308	104,50 €	
  <p>90°</p>	ASDM-CC06-D80x8-d27-Z10	10	5	80	8	17	27	12		88,80 €
	ASDM-CC06-D100x8-d32-Z12	12	6	100	8	25	32	12		104,50 €
	ASDM-CC06-D125x8-d40-Z14	14	7	125	8	35	40	12		156,90 €
	ASDM-CC06-D160x8-d40-Z16	16	8	160	8	52	40	12		209,30 €
	ASDM-CC06-D200x8-d40-Z18	18	9	200	8	70	40	12	CC.. 0602..	261,60 €
	ASDM-CC06-D80x10-d27-Z10	10	5	80	10	17	27	14	ISO	88,80 €
	ASDM-CC06-D100x10-d32-Z12	12	6	100	10	25	32	14		104,50 €
	ASDM-CC06-D125x10-d40-Z14	14	7	125	10	35	40	14		156,90 €
	ASDM-CC06-D160x10-d40-Z16	16	8	160	10	52	40	14		209,30 €
	ASDM-CC06-D200x10-d40-Z18	18	9	200	10	70	40	14		261,60 €
	ASDM-CC09-D80x12-d27-Z08	8	4	80	12	17	27	16		88,80 €
	ASDM-CC09-D100x12-d32-Z10	10	5	100	12	25	32	16		104,50 €
	ASDM-CC09-D125x12-d40-Z12	12	6	125	12	35	40	16		156,90 €
	ASDM-CC09-D160x12-d40-Z14	14	7	160	12	52	40	16		209,30 €
	ASDM-CC09-D200x12-d40-Z16	16	8	200	12	70	40	16	CC.. 09T3..	261,60 €
	ASDM-CC09-D80x14-d27-Z08	8	4	80	14	17	27	18	ISO	88,80 €
	ASDM-CC09-D100x14-d32-Z10	10	5	100	14	25	32	18		104,50 €
	ASDM-CC09-D125x14-d40-Z12	12	6	125	14	35	40	18		156,90 €
	ASDM-CC09-D160x14-d40-Z14	14	7	160	14	52	40	18		209,30 €
	ASDM-CC09-D200x14-d40-Z16	16	8	200	14	70	40	18		261,60 €
	ASDM-CC12-D80x16-d27-Z06	6	3	80	16	17	27	20		88,80 €
	ASDM-CC12-D100x16-d32-Z08	8	4	100	16	25	32	20		104,50 €
	ASDM-CC12-D125x16-d40-Z10	10	5	125	16	35	40	20		156,90 €
	ASDM-CC12-D160x16-d40-Z12	12	6	160	16	52	40	20		209,30 €
	ASDM-CC12-D200x16-d40-Z14	14	7	200	16	70	40	20		261,60 €
	ASDM-CC12-D80x18-d27-Z06	6	3	80	18	17	27	22		88,80 €
	ASDM-CC12-D100x18-d32-Z08	8	4	100	18	25	32	22		104,50 €
	ASDM-CC12-D125x18-d40-Z10	10	5	125	18	35	40	22	CC.. 1204..	156,90 €
	ASDM-CC12-D160x18-d40-Z12	12	6	160	18	52	40	22	ISO	209,30 €
	ASDM-CC12-D200x18-d40-Z14	14	7	200	18	70	40	22		261,60 €
	ASDM-CC12-D250x18-d40-Z16	16	8	250	18	90	40	22		365,70 €
	ASDM-CC12-D80x20-d27-Z06	6	3	80	20	17	27	24		88,80 €
	ASDM-CC12-D100x20-d32-Z08	8	4	100	20	25	32	24		104,50 €
ASDM-CC12-D125x20-d40-Z10	10	5	125	20	35	40	24		156,90 €	
ASDM-CC12-D160x20-d40-Z12	12	6	160	20	52	40	24		209,30 €	
ASDM-CC12-D200x20-d40-Z14	14	7	200	20	70	40	24		261,60 €	
ASDM-CC12-D250x20-d40-Z16	16	8	250	20	90	40	24		365,70 €	

TEKNİK BİLGİLER

Takma Uçlu Matkap (U-DRILL) Kullanma Kılavuzu

Matkabınızı CNC torna tezgahına bağlamadan önce taretin merkezden kaçık olup olmadığını kontrol etmeniz gerekir. Şayet taretinizde kaçıklık varsa, takma uçlu matkabınızı kesinlikle kullanmayınız. Taretin düzeltilmesi için yapılması gereken işlemler ;

1. Taretin tutucusuna kullanacağınız takma uçlu matkabın çapında ve boyunda üzeri hassas olan silindirik bir parça bağlanır ve tezgahın X değeri sıfıra getirilir.

2. Tezgahın aynasına mıknatıslı komprotör saati yerleştirilir. Saatin uç kısmı tarete bağlanmış olduğumuz parçanın üstüne temas ettirilir.

3. Aynanın üzerine bağlanmış olduğumuz mıknatıslı komprotör ayna ile beraber 360 derece döndürülerek saatteki değişim oranına göre taretin sıfırlanması sağlanır.

Takma Uçlu Matkabınızı CNC Tornanızda Daha Verimli Kullanmanız İçin Gerekli Olan Kesme Hızları ve Devirleri :

Grup No.	Malzemenin Cinsi	Malzemenin Öz.	Kesme Hızı Vc (m/dk)
1	Çok Yumuşak İş Çelikleri	C1010, Otomat vb.	220
2	İmalat Çelik ve Döküm Malz.	C1030 - 106 vb.	200
3	Takım ve İmalat Çeşitleri	CK-45, 4140, 7131 vb.	170
4	Sıcak İş ve Paslanmaz Çelikler	İmpaks vb.	150

Devir hesabı yapabilmek için önce malzemeyi seçiniz. Seçtiğiniz malzemenin kesme hızını (Vc) 1000 ile çarpıp 3.14'e bölmeliyiz. Çıkan değeri matkap çapına bölmeliyiz. **ÖRNEK** : Malzememiz takım ve imalat çeliği (3. grup), matkap çapı 25 mm kesme hızı 170 ise $170 \times 1000 = 170000 / 3.14 = 54140$, $54140 / 25 = 2166$ devir çıkar (Tezgahın İş Mili Devri). Tezgahın ilerlemesi kullanacağınız uç ile de alakalı olup 0.05 ile 0.10 arasında değişim gösterir. Kullanıcı kesici ucun kesişine göre bunu ayarlar.

İşleme Merkezleri İçin İlerleme Hesabı :

Yukarıdaki hesaplamalarla bulmuş olduğunuz 2166 iş mili devrini, kesici uç ilerlemesi (mm/devir) 0.05 ile 0.10 arasındaki ilerleme seçenekleri ile çarpılır. **ÖRNEK 1** : $2166 \times 0.05 = 108$ **ÖRNEK 2** : $2166 \times 0.10 = 217$ çıkan sonuçlar 108 ve 217 işleme merkezleri için ilerleme mm/dakika hesabıdır.

Not: D4 ve üzeri takma uçlu matkaplarda tezgahın içten su verme basıncının en az 6 bar olması gerekmektedir.

Frezeleme İşleminde Devir ve İlerleme Hesabı

Vc.	S	D	F	Z	fz	FORMÜLLER
Kesme Hızı (Uç Kutusunun Arkasından Okuyunuz)	İş Mili Devir Sayısı	Tarama Kafası Çapı	İlerleme	Tarama Kafası Ağız Sayısı	Diş Başına Düşen İlerleme Miktarı (Uç Kutusunun Arkasından Okuyunuz)	Devir Hesabı : $S = (Vc \times 1000) / (3,14 \times D)$ İlerleme Hesabı : $F = S \times Z \times fz$

Örnek : D=50 mm çapında, Z=5 ağızlı tarama kafası ile frezeleme yapacağız. Kesici uç kutusunun arkasında kesme hızı Vc=200m/dk. olarak verilmiş olsun. Tezgaha girilecek devri hesaplayalım: **Vc=200 m/dk. D=50 mm** S = Öncelikle Kesme Hızı 1000 ile çarpılır, çıkan sonuç 3,14 sayısına bölünür, buradan çıkan sonuç da tarama kafası çapına bölünür.

$S = 200 \times 1000 = 200000 \rightarrow 200000 / 3,14 = 63663 \rightarrow 63663 / 50 = 1273$ devir **S=1273 dev/dakika** deviri bulduktan sonra ilerlemeyi bulalım : **Z=5** ağızlı tarama kafası olsun **fz=0,12** olarak uç kutusunun arkasından okunmuş olsun F= yukarıda bulmuş olduğumuz devir sayısı ile ağız sayısı çarpılır, çıkan sonuç diş başına düşen ilerleme miktarı ile çarpılır.

$F = 1273 \times 5 = 6365 \rightarrow 6365 \times 0,12 = 763$ F=763 mm/dakika

Tezgaha girilecek olan devir = S 1273 Tezgaha girilecek olan ilerleme : **F 763 ortalama değerdir.**

Not: Vc ve fz değerlerinin uç kutusunun arkasında verilmiş olması gerekir. Eğer bu değerler uç kutusunun üzerinde yoksa, kesici ucun katalogundan bulunuz. İşleyeceğimiz malzeme çelik ise P, paslanmaz çelik ise M, dökme demir ise K bölümünde yazılı olan Vc ve fz değerlerini okuyun.

TEKNİK BİLGİLER

Sıkma Torku Tavsiyeleri

- Takımı Sıkmadan Önce Aşağıdaki Bilgileri Okuyunuz.
Vidalı Takımın Vida Ölçüsü ile Tutucunun İç Vida Ölçüsünü Sıkmadan Önce Kontrol Ediniz.
- Takımı Tutucuya Sıkarken Tablodaki İlgili Değerlere Göre İşlem Yapınız.

Vida	Tork
M6	8
M8	23
M10	46
M12	80
M16	90

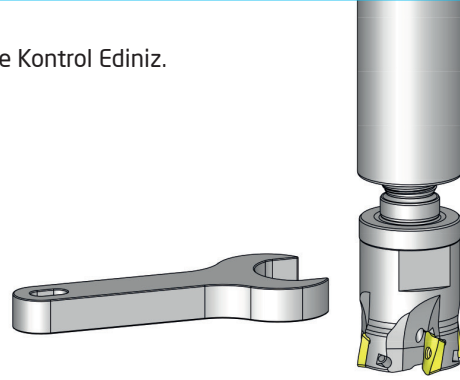

Gövde Malzemesine Göre Delik İçi Kater Uygulama Kılavuzu

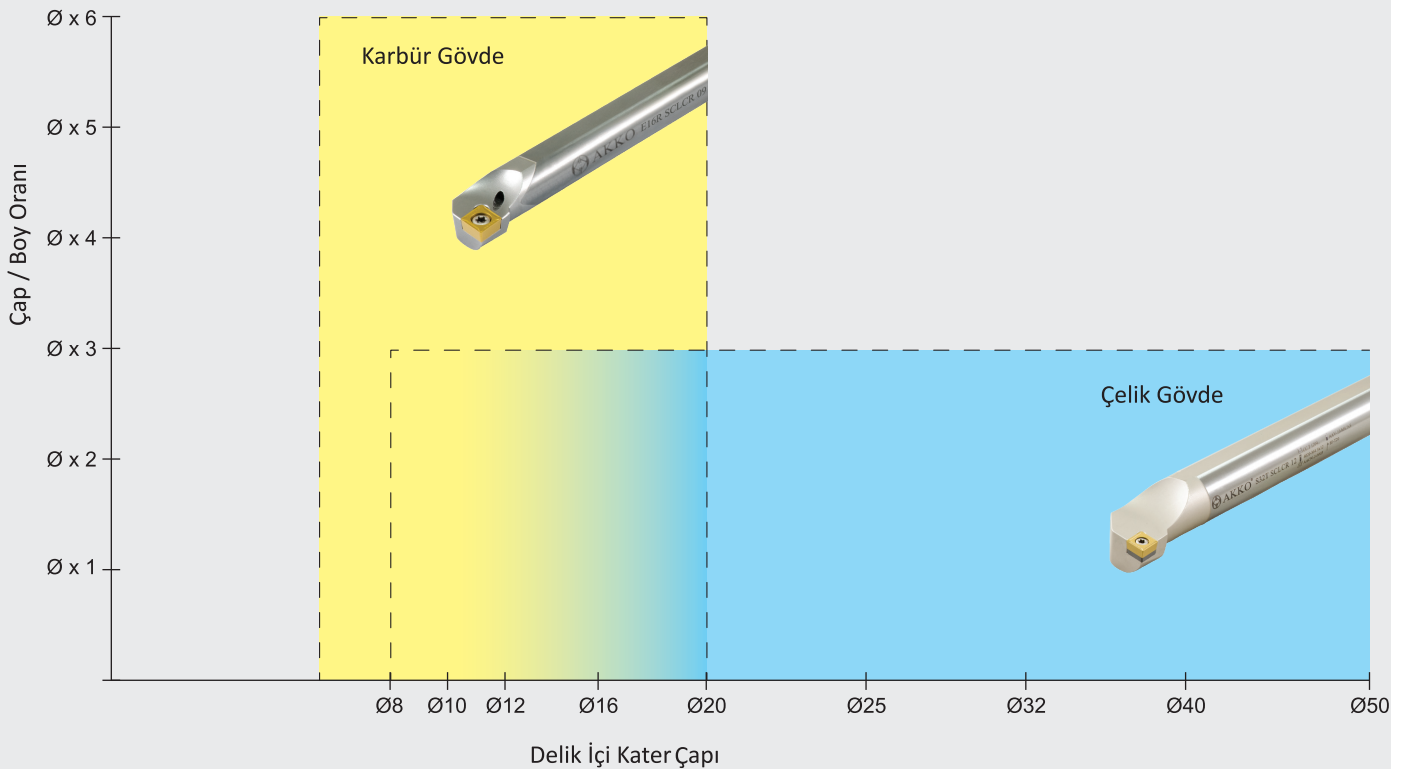

T Kanal Freze Kullanım ve Ön Hazırlama Kılavuzu

T kanal frezelemede talaşın rahat boşaltılması için iş parçası resimde gösterildiği şekilde işlenmelidir.







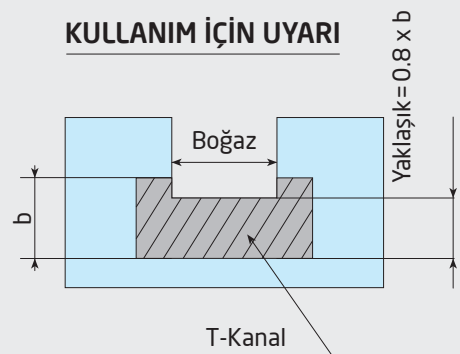



Örnek: ATSM90-CC06- D32X10-W25- L100-Z04 kodlu T freze ile kanal açmadan önce, takımın boğazının çalışacağı kısmın parmak freze ile işlenmesi gerekir. Bu durumda kanalın tamamen işlenmesi çok yanlıştır. Tabanda (0.8 x b = 0.8 x 10) 8mm işlenmeden bırakılmalıdır. Bu bölgeyi T frezenin işlemesi, takımın daha sağlıklı çalışması açısından gereklidir.

İşlenen kanallarda yumuşak kesim için talaşlar uzaklaştırılmış olmalıdır.

KULLANIM İÇİN UYARI



YEDEK PARÇALAR
ALTLIKLAR

ÜRÜN RESMİ	ÜRÜN KODU	ÜRÜN DETAYI		FİYATI
	AATN-2-0001	S-SİSTEM için	TCMT 16 ALTLIK	2,10 €
	AATN-2-0002	T-M SİSTEM için	TNMG 16 ALTLIK	2,10 €
	AATN-3-0025	C-SİSTEM için	TNGN 16 ALTLIK	
	AATN-3-0015	P-SİSTEM için	TNMG 16 ALTLIK	2,10 €
	AATN-2-0020	T-M-P SİSTEM için	TNMG 22 ALTLIK	2,20 €
	AATN-2-0004	DİŞ VİDA 16 ALTLIK		2,20 €
	AATN-2-0004	DİŞ VİDA 22 ALTLIK		2,80 €
	ATS-16E	DİŞ VİDA 16, DİŞ ÇAP SAĞ - DELİK İÇİ SOL ALTLIK		3,60 €
	ATS-16I	DİŞ VİDA 16, DİŞ ÇAP SOL - DELİK İÇİ SAĞ ALTLIK		3,60 €
	ATS-22E	DİŞ VİDA 22, DİŞ ÇAP SAĞ - DELİK İÇİ SOL ALTLIK		5,00 €
	ATS-22I	DİŞ VİDA 22, DİŞ ÇAP SOL - DELİK İÇİ SAĞ ALTLIK		5,00 €
	ATS-27E	DİŞ VİDA 27, DİŞ ÇAP SAĞ - DELİK İÇİ SOL ALTLIK		8,00 €
	ATS-27I	DİŞ VİDA 27, DİŞ ÇAP SOL - DELİK İÇİ SAĞ ALTLIK		8,00 €
	AACN-2-0001	S-SİSTEM için	CCMT 09 ALTLIK	2,10 €
		T-SİSTEM için	CNMG 09 ALTLIK	
	AACN-2-0002	P-SİSTEM için	CNMG 09 ALTLIK	2,10 €
	AACN-2-0003	S-SİSTEM için	CCMT 12 ALTLIK	2,20 €
	AACN-3-0001	T-M-P SİSTEM için	CNMG 12 ALTLIK	2,20 €
		C-SİSTEM için	CNGN 12 ALTLIK	
	AACN-3-0002	T-P SİSTEM için	CNMG 16 ALTLIK	3,00 €
AACN-3-0003	T-P SİSTEM için	CNMG 19 ALTLIK	5,00 €	
AACN-3-0008	T-P SİSTEM için	CNMG 25 ALTLIK	8,00 €	
	AAWN-2-0003	T-M-P SİSTEM için	WNMG 08 KALIN ALTLIK	3,00 €
	AAWN-3-0001	T-M-P SİSTEM için	WNMG 08 ALTLIK	2,20 €
	AAWN-SW317	T-M-P SİSTEM için	WNMG 06 ALTLIK	2,10 €
	AKS-16L	C-SİSTEM için	KNUX-L 16 ALTLIK	2,20 €
	AKS-16R	C-SİSTEM için	KNUX-R 16 ALTLIK	2,20 €
	AASD-3-0001	S-SİSTEM FREZELEME için	SDMT 12 ALTLIK	3,00 €
	AASE-3-0001	S-SİSTEM FREZELEME için	SEMT 13 ALTLIK	3,00 €
	AASN-2-0001	S-SİSTEM için	SCMT 09 ALTLIK	2,10 €
	AASN-2-0002	P-SİSTEM için	SNMG 09 ALTLIK	2,10 €
	AASN-2-0004	S-SİSTEM için	SCMT 12 ALTLIK	2,20 €
	AASN-3-0004	T-P SİSTEM için	SNMG 12 ALTLIK	2,20 €
		C-SİSTEM için	SNGN 12 ALTLIK	
	AASN-3-0023	T-P SİSTEM için	SNMG 15 ALTLIK	3,00 €
	AASN-3-0005	T-P SİSTEM için	SNMG 19 ALTLIK	5,00 €
	AASN-3-0020	T-P SİSTEM için	SNMG 25 ALTLIK	8,00 €
	AASN-20020	PSDNN KARTUŞ için	SNMG 12 ALTLIK	4,00 €
	AADN-2-0001	S-SİSTEM için	DCMT 11 ALTLIK	2,10 €
		T-SİSTEM için	DNMG 11 ALTLIK	
	AADN-SD317	P-SİSTEM için	DNMG 11 ALTLIK	2,10 €
	AADN-3-0001	T-M-P SİSTEM için	DNMG 15 ALTLIK	2,20 €
C-SİSTEM için		DNGN 15 ALTLIK		
AADN-2-0003	T-SİSTEM için	DNMG 15 KALIN ALTLIK	3,00 €	
	AAVN-2-0002	S-SİSTEM için	VCMT 22, VCMT 22 ALTLIK	2,20 €
		T-SİSTEM için	VCMT 16 ALTLIK	
	AAVN-2-0003	S-SİSTEM için	VCMT 22 ALTLIK	3,00 €
	AARC-3-0001	C-SİSTEM için	RCGX 06 ALTLIK	6,00 €
	AARC-3-0002	C-SİSTEM için	RCGX 09 ALTLIK	6,00 €
	AARC-3-0003	C-SİSTEM için	RCGX 12 ALTLIK	6,00 €

YEDEK PARÇALAR

BASKI PABUÇLARI

ÜRÜN RESMİ	ÜRÜN KODU	ÜRÜN DETAYI		FİYATI
	ATK-01	T-SİSTEM için	DNMG 11, WNMG 06, TNMG 16, CNMG 09 BASKI PABUCU	3,00 €
	ATK-02	T-SİSTEM için	CNMG 12, WNMG 08, TNMG 22, DNMG 15, SNMG 12 BASKI PABUCU	3,00 €
	ATK-03	T-SİSTEM için	VNMG 16 BASKI PABUCU	3,00 €
	ATK-04	T-SİSTEM için	CNMG 16, SNMG 15 BASKI PABUCU	3,00 €
	ATKH-01-R	T-SİSTEM için	İÇTEN SOĞUTMA KANALLI BASKI PABUCU	20,00 €
	ATKH-02-L	T-SİSTEM için	İÇTEN SOĞUTMA KANALLI BASKI PABUCU	20,00 €
	AMK-01	M-SİSTEM için	WNMG 06 BASKI PABUCU	3,00 €
	AMK-02	M-SİSTEM için	DELİK İÇİ Ø20 TNMG 16 Ø25 MT-NR/L 16 BASKI PABUCU	3,00 €
	AMK-03	M-SİSTEM için	DNMG 11, CNMG 12 BASKI PABUCU	3,00 €
	AMK-04	M-SİSTEM için	DNMG 15, TNMG 16-22 BASKI PABUCU	3,00 €
	AMK-05	M-SİSTEM için	WNMG 08 BASKI PABUCU	3,00 €
	AMK-07	M-SİSTEM için	S20R MCLNR/L BASKI PABUCU	3,00 €
	ACK-01-R	C-SİSTEM için	KNUX-R BASKI PABUCU	3,00 €
	ACK-02-L	C-SİSTEM için	KNUX-L BASKI PABUCU	3,00 €
	ACK-03	C SİSTEM için	154.91 DIŞ ÇAP ve DELİK İÇİ Ø25-Ø32 BASKI PABUCU	3,00 €
	ACK-04	P-C SİSTEM için	CTFPR KARTUŞ BASKI PABUCU	3,00 €
	ACK-05	P-C SİSTEM için	FREZELEME ve DIŞ VİDA AÇMA TAKIMLARINA GÖRE İLAVE BASKI PABUCU	3,00 €
	ACK-06	C-SİSTEM için	154.91 DELİK İÇİ Ø16-Ø20 BASKI PABUCU	3,00 €
	ACK-07	C-SİSTEM için	SERAMİK CNGN, SNGN, DNGN YEDEK TAKIMI	5,50 €
	ACK-08	C-SİSTEM için	SERAMİK TNGN YEDEK TAKIMI	5,50 €

YEDEK PARÇALAR
BASKI PABUÇLARI

ÜRÜN RESMİ	ÜRÜN KODU	ÜRÜN DETAYI		FİYATI
	ACK-09	P-SİSTEM için	CNMG 16-19, SNMG 15-19 İLAVE BÜYÜK BASKI PABUCU	3,00 €
	ACK-10	C-SİSTEM FREZELEME için	SPKN 12 ve Ø50-Ø63 TPKN 16 BASKI PABUCU (M8x8)	3,00 €
	ACK-11	C-SİSTEM FREZELEME için	Ø80-Ø100 TPKN 16-TPKN 22, OFKR 07, HNMX 09 BASKI PABUCU (M8x10)	3,00 €
	ACK-12	C-SİSTEM için	CTSPR KARTUŞ BASKI PABUCU	3,00 €
	ACK-15	S-SİSTEM FREZELEME için	RD.. 10-12 BASKI PABUCU	3,00 €
	ACK-19	S-SİSTEM FREZELEME için	WD0805D BASKI PABUCU	3,00 €
	ACK-21	C-SİSTEM için	SN.. 1204.. BASKI PABUCU	5,00 €
	ACK-23	C-SİSTEM için	SERAMİK DNGN 11, YEDEK TAKIMI	5,50 €
	ACK-24	S-SİSTEM FREZELEME için	XD0806D BASKI PABUCU	3,00 €
	ACK-26	C-SİSTEM FREZELEME için	XNMU 0806..BASKI PABUCU	3,00 €
	ACK-27	C-SİSTEM için	RCGX 06 BASKI PABUCU	6,00 €
	ACK-28	C-SİSTEM için	RCGX 09 BASKI PABUCU	6,00 €
	ACK-29	C-SİSTEM için	RCGX 12 BASKI PABUCU	6,00 €
	AKK-04	KANAL KATERİ için	ADKT-H22 - S312 - (0.5-2) BASKI PABUCU	6,00 €



YEDEK PARÇALAR

BASKI PABUÇ VİDALARI

ÜRÜN RESMİ	ÜRÜN KODU	ÜRÜN DETAYI	FİYATI
	AKV-01-M5X22	T-SİSTEM için DNMG 11, WNMG 06, TNMG 16 BASKI PABUÇ VİDASI (M5X20)	0,80 €
	AKV-02-M6X22	T-SİSTEM için CNMG 12, WNMG 08, TNMG 22, DNMG 15, SNMG 12-15 VNMG 16 BASKI PABUÇ VİDASI (M6X20)	0,80 €
		M-SİSTEM için TNMG 16-22, DNMG 15 BASKI PABUÇ VİDASI (M6X20)	
	AKV-03-M6X22	M-SİSTEM için WNMG 08 BASKI PABUÇ VİDASI (M6X20)	0,80 €
	AKV-04-M5X17	M-SİSTEM için S20R MT-NR/L 16, S20R-S25S MWLNR/L 06, S25S MDUNR/L 11-Dış Çap MWLNR 06 (M5X20)	0,80 €
	AKV-05-M6X25	T-SİSTEM için CNMG 16 ESKİ BASKI PABUÇ VİDASI (M6X25)	0,80 €
	AKV-06-M6X20	C-SİSTEM için KNUX 16 BASKI PABUÇ VİDASI (M6X20)	1,00 €
	AKV-07-M6X22	C-SİSTEM için ADKT-154.91, AIKT-154.91-R/L-32 BASKI PABUÇ VİDASI (M6X20)	0,80 €
	AKV-10-M6X14	C-SİSTEM için AIKT-154.91-R/L-16, AIKT-154.91-R/L-20, AIKT-154.91-R/L-25 BASKI PABUÇ VİDASI (M6X15)	0,80 €
	AKV-11-M8X29	C-SİSTEM için TNGN, CNGN, DNGN, SNGN BASKI PABUÇ VİDASI (M8X33)	1,00 €
	AAV-05-M6X15	P-SİSTEM için CNMG 16-19, SNMG 15-19 İLAVE BÜYÜK BASKI PABUCU VİDASI (M6X15)	0,50 €
	AKV-12-M5X12	C-SİSTEM için CTSPR BASKI PABUCU VİDASI (M5X9)	0,50 €
	AKV-13-M8X1X16	C-SİSTEM FREZELEME için SPKN 12 ve Ø63 TPKN 16 BASKI PABUCU VİDASI (M8X1X16)	1,00 €
	AKV-14-M8X1X18	C-SİSTEM FREZELEME için Ø80-Ø100 TPKN 16 ve Ø63-Ø315 TPKN 22 BASKI PABUCU VİDASI (M8X1X18)	1,00 €
	AKV-15-M8X1X20	C-SİSTEM FREZELEME için OFKR 07, HNMX 09 VİDASI (M8X1X20)	1,00 €
	AKV-16-M6X16	C-SİSTEM için CTFPR 13CS 16 BASKI PABUCU VİDASI (M6X16)	1,00 €
	AKV-17-M5X15	M-SİSTEM için S16P MWLNR/L BASKI PABUCU VİDASI (M5X18)	0,80 €
	AKV-18-M5X14	C-SİSTEM FREZELEME için SN19 BASKI PABUCU VİDASI (M5X0.8)	0,80 €
	AKV-19-M7X25	T-SİSTEM için CNMG 16 BASKI PABUCU VİDASI (M7X25)	1,00 €
	AKV-20-M6X19	M-SİSTEM için S25S MDUNR/L 15 BASKI PABUÇ VİDASI (M6X19)	0,80 €
	AKV-21-M6X18	C-SİSTEM için AIKT-154.91-R/L-25 BASKI PABUÇ VİDASI (M6X18)	0,80 €
	AKV-22-M8X1X14	C-SİSTEM FREZELEME için Ø50 TPKN 16 BASKI PABUCU VİDASI (M8X1X14)	1,00 €
AKV-24-M6X1X18	C-SİSTEM FREZELEME için SN.. 1204 BASKI PABUCU VİDASI	1,00 €	

YEDEK PARÇALAR

BASKI PABUÇ VİDALARI

ÜRÜN RESMİ	ÜRÜN KODU	ÜRÜN DETAYI		FİYATI
	AKV-26-M6X0.75X20	C-SİSTEM FREZELEME için	XNMU 0806.. BASKI PABUCU VİDASI	1,00 €
	AKV-27-M6X20	M-SİSTEM için	S25S MWLNR/L 08 BASKI PABUCU VİDASI	0,80 €
	AKV-28-M10x1.5x43	WNMU 0907.. Ø50 MONTAJ VİDASI	Ø50 WNMU 0907.. BASKI PABUCU VİDASI	7,80 €
	AKV-29-M6X29	ADKT-H22.. KEP VİDASI	ADKT-H22.. SIKMA VİDASI	1,50 €
	AKV-30-M6X22	T-SİSTEM için	İÇTEN SOĞUTMA KANALLI BASKI PABUCU VİDASI	0,80 €
	AKV-33-M6X22	T-SİSTEM için	İÇTEN SOĞUTMA KANALLI BASKI PABUCU VİDASI	0,80 €

SOĞUTMA NOZULU

ÜRÜN RESMİ	ÜRÜN KODU	ÜRÜN DETAYI	FİYATI
	AN-01	SOĞUTMA NOZULU	13,00 €

ALTLIK VİDALARI

ÜRÜN RESMİ	ÜRÜN KODU	ÜRÜN DETAYI		FİYATI
	AAV-01-M3X10	T-SİSTEM için	WNMG 06, KNUX 16 ALTLIK VİDASI	0,50 €
	AAV-02-M5X12	T-SİSTEM için	CNMG 12, WNMG 08, TNMG 22, DNMG 15, SNMG 12	0,50 €
		C-SİSTEM için	CNGN 12, SNGN 12, DNGN 15 ALTLIK VİDASI	
	AAV-03-M5X12	T-SİSTEM için	TNMG 16 ALTLIK VİDASI	0,50 €
		C-SİSTEM için	TNGN 16 ALTLIK VİDASI	
	AAV-04-M5X12	T-SİSTEM için	VNMG 16, DNMG 11, CNMG 09 ALTLIK VİDASI	0,50 €
	AAV-05-M6X15	T-SİSTEM için	CNMG 16 ALTLIK VİDASI	0,50 €
	AAV-06-M3.5X11	S-SİSTEM için	CCMT 09, DCMT 11, VBMT 16, VCMT 16	1,50 €
			TCMT 16, DİŞ VİDA 16 ALTLIK VİDASI (M3.5 BUKSE VİDA)	
	AAV-07-M4.5X13	S-SİSTEM için	CCMT 12, SCMT 12, DİŞ VİDA 22	1,50 €
			ALTLIK VİDASI (M4.5 BUKSE VİDA)	
	AAV-08-M3.5X8	S-SİSTEM için	(M3.5x8 KISA BUKSE VİDA)	1,50 €
	AAV-09-M5X9	T-SİSTEM için	S25S TCLNR/L 09, S25S TDUNR/L 11, S25S TDQNR/L 11 ALTLIK VİDASI	0,50 €
	AAV-10-M4.5X8	S-SİSTEM için	(M4.5x8 KISA BUKSE VİDA)	1,50 €
	AAV-11-U5-40X4.5	S-SİSTEM için	DİŞ AÇMA TAKIMLARI için 16 ER/L, 16 IR/L ALTLIK VİDASI	1,00 €
	AAV-12-U8-32X5.5	S-SİSTEM için	DİŞ AÇMA TAKIMLARI için 22 ER/L, 22 IR/L ALTLIK VİDASI	1,00 €
AAV-13-M5X8	T-SİSTEM için	S25S TSKNR/L 12, S25S TCLNR/L 12, S25S TWLNR/L 08 ALTLIK VİDASI	0,50 €	
AAV-14-M5X14	ADCR için	ADCR MONTAJ VİDASI	0,50 €	
AAV-14-M5X20	ATUM için	ADCR PAHLAMA BİLEZİĞİ MONTAJ VİDASI	0,50 €	
AAV-15-M5X5.7	S-SİSTEM için	DİŞ AÇMA TAKIMLARI için 27 ER/L, 27 IR/L ALTLIK VİDASI	1,00 €	
AAV-16-M3.5X8	S-SİSTEM için	SEMT 13 ALTLIK VİDASI	1,50 €	

YEDEK PARÇALAR

PİMLER

ÜRÜN RESMİ	ÜRÜN KODU	ÜRÜN DETAYI		FİYATI
	APM-01	M-SİSTEM için	DELİK İÇİ Ø25-Ø32-Ø40 ve DIŞ ÇAP TNMG 16 PİMİ	1,00 €
	APM-02	M-SİSTEM için	TNMG 22, WNMG 08 PİMİ	1,00 €
	APM-03	M-SİSTEM için	S20R MTFNR/L 16, S20R MT-NR/L 16, S20R MTUNR/L 16, S20R MTQNR/L 16, S20R MDUNR/L 11 PİMİ	1,00 €
	APM-04	M-SİSTEM için	S32T MCLNR/L 12, DNMG 15, S25S MWLNR/L 08 PİMİ	1,00 €
	APM-05	M-SİSTEM için	MSYNR 11.5CS 12 KARTUŞ için SNMG 12 PİMİ	2,00 €
	APM-06	C-SİSTEM için	154.91 PİMİ	1,00 €
	APM-07	M-SİSTEM için	S20R ET-NR 16 PİMİ	3,00 €
	APM-08	M-SİSTEM için	S25S MWLNR/L 06, DIŞ ÇAP PİMİ	1,00 €
	APM-09	M-SİSTEM için	S16P MWLNR/L 06 PİMİ	1,00 €
	APM-10	M-SİSTEM için	S20R MWLNR/L 06 PİMİ	1,00 €
	APM-11	M-SİSTEM için	S20R MTQNR/L 16 PİMİ	1,00 €
	APM-12	M-SİSTEM için	S20R MCLNR/L 12, S25S MCLNR/L 12-Z PİMİ	1,00 €
	APM-13	M-SİSTEM için	S25S MCLNR/L 12 PİMİ	1,00 €
	APM-14	M-SİSTEM için	S25S MTFNR/L 16, S25S MT-NR/L 16, S25S MTUNR/L 16, S25S MTQNR/L 16 PİMİ	1,00 €
	APM-15	M-SİSTEM için	MSYNR 16CS 12 KARTUŞ için SNMG 12 PİMİ	2,00 €

SEKMAN

ÜRÜN RESMİ	ÜRÜN KODU	ÜRÜN DETAYI		FİYATI
	ACS-01	C-SİSTEM için	TNGN, CNGN, DNGN, SNGN, SEKMANI	0,50 €
	AS-01	T-M-SİSTEM için	AKV-30-M6x22 SEKMANI	0,50 €
	AS-02	T SİSTEM için	AKV-19-M7x25 SEKMANI	0,50 €

ORING

ÜRÜN RESMİ	ÜRÜN KODU	ÜRÜN DETAYI		FİYATI
	AOR-01	P-SİSTEM için	ORING	0,50 €
	AXR-01	T-P SİSTEM için	ORING	0,50 €

BASKI PULLARI

ÜRÜN RESMİ	ÜRÜN KODU	ÜRÜN DETAYI		FİYATI
	ABPL-01	T-SİSTEM için	DNMG 11-15, WNMG 06-08, TNMG 16-22, VNMG 16, CNMG 12, SNMG 12 BASKI PULU	0,10 €
		M-SİSTEM için	DELİK İÇİ Ø25-Ø32-Ø40 ve DIŞ ÇAP TNMG 16-22, DNMG 15, WNMG 08 BASKI PULU	
		C-SİSTEM için	KNUX 16 BASKI PULU	
	ABPL-02	T-SİSTEM için	CNMG 16 BASKI PULU	0,10 €
	ABPL-03	TER/L - TIR/L için	TER - TIR 16 ER/EL - IR/IL ALTLIK VİDA PULU	0,10 €
	ABPL-04	TER/L - TIR/L için	TER - TIR 22 ER/EL - IR/IL ALTLIK VİDA PULU	0,10 €
	ABPL-05	TER/L - TIR/L için	TER - TIR 27 ER/EL - IR/IL ALTLIK VİDA PULU	0,10 €

YEDEK PARÇALAR

BASKI YAYLARI

ÜRÜN RESMİ	ÜRÜN KODU	ÜRÜN DETAYI		FİYATI
	AKY-01	T-SİSTEM için	CNMG 12, WNMG 08, TNMG 22, DNMG 15, SNMG 12, VNMG 16 BASKI YAYI	0,50 €
	AKY-02	C-SİSTEM için	KNUX 16 BASKI YAYI	0,50 €

LEVYELER

ÜRÜN RESMİ	ÜRÜN KODU	ÜRÜN DETAYI		FİYATI
	APL-01	P-SİSTEM için	CNMG 09, DNMG 11, SNMG 09, TNMG 16, WNMG 06 LEVYESİ	3,50 €
	APL-02	P-SİSTEM için	CNMG 12, SNMG 12, TNMG 22, WNMG 08 LEVYESİ	3,50 €
	APL-03	P-SİSTEM için	DNMG 15 LEVYESİ	3,50 €
	APL-04	P-SİSTEM için	CNMG 16, SNMG 15 LEVYESİ	3,50 €
	APL-05	P-SİSTEM için	CNMG 19, SNMG 19 LEVYESİ	6,00 €
	APL-06	P-SİSTEM için	CNMG 25, SNMG 25 LEVYESİ	9,00 €
	APL-07	P-SİSTEM için	S16P PCLNR/L 09, S16P PTUNR/L 16 LEVYESİ	3,50 €
	APL-08	P-SİSTEM için	S16P PTUNR/L 16 LEVYESİ	3,50 €







LEVYE VİDALARI

ÜRÜN RESMİ	ÜRÜN KODU	ÜRÜN DETAYI		FİYATI
	ALV-01-M6X14	P-SİSTEM için	DELİK İÇİ Ø20 DNMG 11 Ø20 TNMG 16 LEVYE VİDASI (M6X14)	1,20 €
	ALV-02-M6X17	P-SİSTEM için	DNMG 11, TNMG 16, WNMG 06 LEVYE VİDASI (M6X17)	1,20 €
	ALV-03-M8X19	P-SİSTEM için	CNMG 12, SNMG 12, TNMG 22, WNMG 08, DNMG 15 LEVYE VİDASI (M8X19)	1,20 €
	ALV-04-M8X22	P-SİSTEM için	CNMG 16, SNMG 15 LEVYE VİDASI (M8X22)	1,20 €
	ALV-05-M10X27	P-SİSTEM için	CNMG 19, SNMG 19 LEVYE VİDASI (M10X27)	1,40 €
	ALV-06-M12X36	P-SİSTEM için	CNMG 25, SNMG 25 LEVYE VİDASI (M12X36)	2,60 €
	ALV-07-M6X13	P-SİSTEM için	S16P PCLNR/L 09, S16P PCTUR/L 16 LEVYE VİDASI (M6X13)	1,20 €
	ALV-08-M8X16	P-SİSTEM için	S25S PCLNR/L 12, S25S PDUNR/L 15, S25S PSKNR/L 12 LEVYE VİDASI	1,20 €







YEDEK PARÇALAR

TORK VİDALARI

ÜRÜN RESMİ	ÜRÜN KODU	ÜRÜN DETAYI		FİYATI
	4006-M1.6X3.2	S-SİSTEM için	TORK VİDA	2,00 €
	3006-M1.8X4	S-SİSTEM için	TORK VİDA	2,50 €
	3006-M2x3.1	S-SİSTEM için	TORK VİDA	2,00 €
	3006-M2x3.3	S-SİSTEM için	TORK VİDA	2,00 €
	3006-M2X3.6	S-SİSTEM için	TORK VİDA	2,00 €
	3006-M2X4	S-SİSTEM için	TORK VİDA	2,00 €
	4006-M2X5	S-SİSTEM için	TORK VİDA	1,00 €
	3007-M2.2X5	S-SİSTEM için	TORK VİDA	2,00 €
	4006-M2.2X5	S-SİSTEM için	TORK VİDA	1,00 €
	1008-M2.5X5	S-SİSTEM için	TORK VİDA	0,50 €
	1008-M2.5X7	S-SİSTEM için	TORK VİDA	0,50 €
	1108-M2.5x6	S-SİSTEM için	TORK VİDA	3,00 €
	3008-M2.5X5	S-SİSTEM için	TORK VİDA	2,00 €
	3008-M2.5X6	S-SİSTEM için	TORK VİDA	2,00 €
	3008-M2.5X8	S-SİSTEM için	TORK VİDA	2,00 €
	4008-M2.5X4	S-SİSTEM için	TORK VİDA	1,00 €
	4008-M2.5X4.5	S-SİSTEM için	TORK VİDA	1,00 €
	4008-M2.5X6	S-SİSTEM için	TORK VİDA	1,00 €
	4008-M2.5x6.5	S-SİSTEM için	TORK VİDA	1,00 €
	4108-M2.5x6.5	S-SİSTEM için	TORK VİDA	1,00 €
	4108-M2.5x8	S-SİSTEM için	TORK VİDA	1,00 €
	1008-M3X6	S-SİSTEM için	TORK VİDA	0,50 €
	1008-M3X8	S-SİSTEM için	TORK VİDA	0,50 €
	1108-M3x6.8	S-SİSTEM için	TORK VİDA	3,00 €
	3008-M3X6	S-SİSTEM için	TORK VİDA	2,00 €
	3008-M3X7	S-SİSTEM için	TORK VİDA	2,00 €
	3008-M3X8	S-SİSTEM için	TORK VİDA	2,00 €
	3108-M3x6	S-SİSTEM için	TORK VİDA	2,00 €
	3108-M3X8	S-SİSTEM için	TORK VİDA	2,00 €
	4008-M3X8	S-SİSTEM için	TORK VİDA	1,00 €
	4010-M3X6	S-SİSTEM için	TORK VİDA	1,00 €
	4010-M3X8	S-SİSTEM için	TORK VİDA	1,00 €
	1015-M3.5X9	S-SİSTEM için	TORK VİDA	0,50 €
	1015-M3.5X11	S-SİSTEM için	TORK VİDA	0,50 €
	1015-M3.5X14	S-SİSTEM için	TORK VİDA	0,50 €
	1315-M3.5X11	S-SİSTEM için	TORK VİDA	0,50 €
	1510-M3.5X7	S-SİSTEM için	TORK VİDA	0,50 €
	1510-M3.5X9	S-SİSTEM için	TORK VİDA	0,50 €
	1615-M3.5X10	S-SİSTEM için	TORK VİDA	0,50 €
	1615-M3.5X11	S-SİSTEM için	TORK VİDA	0,50 €
	1615-M3.5X15	S-SİSTEM için	TORK VİDA	0,50 €
	3010-M3.5X7	S-SİSTEM için	TORK VİDA	2,00 €
	3010-M3.5X9	S-SİSTEM için	TORK VİDA	2,00 €
	3015-M3.5X9	S-SİSTEM için	TORK VİDA	2,00 €
	4015-M3.5X8	S-SİSTEM için	TORK VİDA	1,00 €
	4015-M3.5X9	S-SİSTEM için	TORK VİDA	1,00 €
	4015-M3.5X10	S-SİSTEM için	TORK VİDA	1,00 €
	4015-M3.5X11	S-SİSTEM için	TORK VİDA	1,00 €
	4015-M3.5X12	S-SİSTEM için	TORK VİDA	1,00 €
	4015-M3.5X14	S-SİSTEM için	TORK VİDA	1,00 €
	1015-M4x8	S-SİSTEM için	TORK VİDA	1,50 €
	1015-M4X9	S-SİSTEM için	TORK VİDA	1,50 €
	1515-M4X9	S-SİSTEM için	TORK VİDA	0,50 €
	1115-M4x10	S-SİSTEM için	TORK VİDA	3,00 €
	1015-M4X11	S-SİSTEM için	TORK VİDA	1,50 €
	1315-M4X11	S-SİSTEM için	TORK VİDA	0,50 €
	1415-M4X11	S-SİSTEM için	TORK VİDA	0,50 €
	1515-M4X11	S-SİSTEM için	TORK VİDA	0,50 €
	1615-M4X11	S-SİSTEM için	TORK VİDA	0,50 €
	3015-M4X9	S-SİSTEM için	TORK VİDA	2,00 €

YEDEK PARÇALAR
TORK VİDALARI

ÜRÜN RESMİ	ÜRÜN KODU	ÜRÜN DETAYI		FİYATI	
	3015-M4X11	S-SİSTEM için	TORK VİDA	2,00 €	
	4015-M4x8	S-SİSTEM için	TORK VİDA	1,00 €	
	4015-M4X9	S-SİSTEM için	TORK VİDA	1,00 €	
	4015-M4x10	S-SİSTEM için	TORK VİDA	1,00 €	
	4015-M4X11	S-SİSTEM için	TORK VİDA	1,00 €	
	4015-M4X12	S-SİSTEM için	TORK VİDA	1,00 €	
	4115-M4X12	S-SİSTEM için	TORK VİDA	1,00 €	
	4515-M4x8	S-SİSTEM için	TORK VİDA	1,00 €	
	4515-M4X11	S-SİSTEM için	TORK VİDA	1,00 €	
	4615-M4X11	S-SİSTEM için	TORK VİDA	1,00 €	
		1020-M4.5x14	S-SİSTEM için	TORK VİDA	0,50 €
		1020-M4.5X16	S-SİSTEM için	TORK VİDA	0,50 €
		1120-M4.5X12	S-SİSTEM için	TORK VİDA	1,50 €
		1515-M4.5X11	S-SİSTEM için	TORK VİDA	0,50 €
		4015-M4.5X11	S-SİSTEM için	TORK VİDA	1,00 €
		4020-M4.5X10	S-SİSTEM için	TORK VİDA	1,00 €
		4020-M4.5X12	S-SİSTEM için	TORK VİDA	1,00 €
		1020-M5x7.5	S-SİSTEM için	TORK VİDA	0,50 €
		1020-M5X11	S-SİSTEM için	TORK VİDA	0,50 €
		1120-M5X13	S-SİSTEM için	TORK VİDA	1,80 €
	1020-M5X14	S-SİSTEM için	TORK VİDA	0,50 €	
	1615-M5x14	S-SİSTEM için	TORK VİDA	1,50 €	
	1620-M5X18	S-SİSTEM için	TORK VİDA	1,80 €	
	1620-M5X22	S-SİSTEM için	TORK VİDA	1,80 €	
	4420-M5X14	S-SİSTEM için	TORK VİDA	1,00 €	
	1020-M6X16	S-SİSTEM için	TORK VİDA	0,70 €	
	1420-M6X16	S-SİSTEM için	TORK VİDA	0,70 €	
	1520-M6X16	S-SİSTEM için	TORK VİDA	0,70 €	
	1710-U5-40X12.2	S-SİSTEM için	TORK VİDA	1,80 €	
	1720-U8-32x10	S-SİSTEM için	TORK VİDA	1,80 €	
	1720-U8-32X15	S-SİSTEM için	TORK VİDA	1,80 €	
	1707-U4-48x6	S-SİSTEM için	TORK VİDA	2,50 €	
	1707-U4-48x6.5	S-SİSTEM için	TORK VİDA	2,50 €	
	1707-U4-48X8.2	S-SİSTEM için	TORK VİDA	2,50 €	



YEDEK PARÇALAR

ALTLIK YAYLARI

ÜRÜN RESMİ	ÜRÜN KODU	ÜRÜN DETAYI		FİYATI
	AAY-01	P-SİSTEM için	DNMG 11, TNMG 16, WNMG 06, CNMG 09, SNMG 09 ALTLIK YAYI	0,70 €
	AAY-02	P-SİSTEM için	CNMG 12, SNMG 12, TNMG 22, WNMG 08, DNMG 15 ALTLIK YAYI	0,70 €
	AAY-03	P-SİSTEM için	CNMG 16, SNMG 15 ALTLIK YAYI	0,70 €
	AAY-04	P-SİSTEM için	CNMG 19, SNMG 19 ALTLIK YAYI	0,70 €
	AAY-05	P-SİSTEM için	CNMG 25, SNMG 25 ALTLIK YAYI	0,70 €
	AAY-07	P-SİSTEM için	CNMG 09, TNMG 16 ALTLIK YAYI	0,70 €

KÜRESEL FREZELEME VİDALARI

ÜRÜN RESMİ	ÜRÜN KODU	ÜRÜN DETAYI		FİYATI
	1208-M3x7	KÜRESEL FREZE VİDASI-P3208 UÇ VİDASI		3,00 €
	1215-M4X0.5X9	KÜRESEL FREZE VİDASI-P3210-ROHX 12 UÇ VİDASI		3,00 €
	1220-M5X0.5X9	KÜRESEL FREZE VİDASI-P3212 UÇ VİDASI		3,00 €
	1220-M5X0.5X12	KÜRESEL FREZE VİDASI-P3216-ROHX 16 UÇ VİDASI		3,00 €
	1220-M5X0.5X15	KÜRESEL FREZE VİDASI-P3220-ROHX 20 UÇ VİDASI		3,00 €
	1220-M6X0.75X20	KÜRESEL FREZE VİDASI-P3225 UÇ VİDASI		4,00 €
	1204-M8X0.75X26	KÜRESEL FREZE VİDASI-P3232 UÇ VİDASI		5,00 €
	1210-M3.5X9.6	KÜRESEL FREZE VİDASI-BNM 12 UÇ VİDASI		5,00 €
	1215-M4X13.5	KÜRESEL FREZE VİDASI-BNM 16 UÇ VİDASI		5,00 €

EKSANTRİK VİDA

ÜRÜN RESMİ	ÜRÜN KODU	ÜRÜN DETAYI		FİYATI
	AEV-01-M6x16	KARTUŞ EKSANTRİK VİDASI		3,00 €

KESME ve KANAL LAMA AÇMA BLOK PABUÇLARI

ÜRÜN RESMİ	ÜRÜN KODU	ÜRÜN DETAYI		FİYATI
	ABK-01	LAMA BLOĞU için	ALBU-20-26 BASKI PABUCU	10,00 €
	ABK-02	LAMA BLOĞU için	ALBU-25-26 BASKI PABUCU	10,00 €
	ABK-03	LAMA BLOĞU için	ALBU-20-32 BASKI PABUCU	11,00 €
	ABK-04	LAMA BLOĞU için	ALBU-25-32, ALBU-32-32 BASKI PABUCU	11,00 €

SIZDIRMAZ VİDALAR

ÜRÜN RESMİ	ÜRÜN KODU	ÜRÜN DETAYI		FİYATI
	2704-M8x1x5	İÇTEN SOĞUTMA KANALLI TAKIMLAR için	JET TAKIMLAR için	0,50 €
	2705-G1/8x5.5	İÇTEN SOĞUTMA KANALLI TAKIMLAR için	JET TAKIMLAR için	0,80 €

YEDEK PARÇALAR
MONTAJ VE AYAR VİDALARI

ÜRÜN RESMİ	ÜRÜN KODU	ÜRÜN DETAYI	FİYATI
	2406-M8x30	A16 MONTAJ VİDASI (KAFASI KÜÇÜK)	0,80 €
	2506-M8x30	A16 MONTAJ VİDASI	0,80 €
	2407-M10x30	A22 MONTAJ VİDASI	0,80 €
	2408-M10x30	A22 MONTAJ VİDASI (KAFASI KÜÇÜK)	0,80 €
	2508-M10x30	A22 MONTAJ VİDASI	0,80 €
	2408-M12x35	A27 MONTAJ VİDASI	0,80 €
	2410-M12x35	A27 MONTAJ VİDASI (KAFASI KÜÇÜK)	0,80 €
	2510-M12x35	A27 MONTAJ VİDASI	0,80 €
	2514-M16x35	A32 MONTAJ VİDASI	0,80 €
	2504-M5x16	KARTUŞ MONTAJ VİDASI	0,80 €
	2505-M6x16	KARTUŞ MONTAJ VİDASI	0,80 €
	2505-M6x40	KARTUŞ MONTAJ VİDASI	0,80 €
	2506-M8x20	KARTUŞ MONTAJ VİDASI	0,80 €
	AKV-23-M4x10	KARTUŞ MONTAJ VİDASI	0,80 €
	2600-M4x9.5	KARTUŞ EKSENEL AYAR VİDASI	0,80 €
	2600-M5x13	KARTUŞ EKSENEL AYAR VİDASI	0,80 €
	2600-M6x18	KARTUŞ EKSENEL AYAR VİDASI	0,80 €
	2702-M4x4	KARTUŞ RADYAL AYAR VİDASI	0,50 €
	2702-M4x10	KARTUŞ RADYAL AYAR VİDASI	0,50 €
	2725-M5x6	KARTUŞ RADYAL AYAR VİDASI	0,50 €
2725-M5x10	KARTUŞ RADYAL AYAR VİDASI	0,50 €	

ALYAN ANAHTARLARI

ÜRÜN RESMİ	ÜRÜN KODU	ÜRÜN DETAYI	FİYATI
	AAL-01-2 mm	ALYAN ANAHTARI	0,50 €
	AAL-02-2.5 mm	ALYAN ANAHTARI	0,50 €
	AAL-03-3 mm	ALYAN ANAHTARI	0,50 €
	AAL-05-4 mm	ALYAN ANAHTARI	0,60 €
	AAL-07-5 mm	ALYAN ANAHTARI	0,70 €
	AAL-08-6 mm	ALYAN ANAHTARI	1,25 €
	AAL-09-1.5 mm	ALYAN ANAHTARI	0,50 €
	AAL-11-8 mm	ALYAN ANAHTARI	2,00 €
	AAL-12-10 mm	ALYAN ANAHTARI	3,00 €

TORK ANAHTARLARI

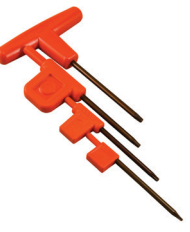
ÜRÜN RESMİ	ÜRÜN KODU	ÜRÜN DETAYI	FİYATI
	80-T06	TORK ANAHTARI	1,50 €
	80-T07	TORK ANAHTARI	1,50 €
	80-T08	TORK ANAHTARI	1,50 €
	80-T10	TORK ANAHTARI	1,50 €
	80-T15	TORK ANAHTARI	1,50 €
	80-T20	TORK ANAHTARI	1,50 €
	81-T15	T-TİP TORK ANAHTARI	1,50 €
	81-T20	T-TİP TORK ANAHTARI	1,50 €

LAMA ANAHTARI

ÜRÜN RESMİ	ÜRÜN KODU	ÜRÜN DETAYI	FİYATI
	ALA-01	AKL LAMA ANAHTARI	6,00 €

YEDEK PARÇALAR

BARALAMA TAKIMLARI

ÜRÜN RESMİ	ÜRÜN KODU	ÜRÜN DETAYI	FİYATI
	ABKS-D16	ABKS-D16 KARTUŞ SABİTLEME PABUCU	3,00 €
	ABKS-D20	ABKS-D20 KARTUŞ SABİTLEME PABUCU	3,00 €
	ABKS-D25	ABKS-D25 KARTUŞ SABİTLEME PABUCU	3,00 €
	ABKS-D32	ABKS-D32 KARTUŞ SABİTLEME PABUCU	3,00 €
	ABKS-D40	ABKS-D40 KARTUŞ SABİTLEME PABUCU	3,00 €
	ABKS-D50	ABKS-D50 KARTUŞ SABİTLEME PABUCU	5,00 €
	ABKS-D63	ABKS-D63 KARTUŞ SABİTLEME PABUCU	5,00 €
	ABKS-D80	ABKS-D80 KARTUŞ SABİTLEME PABUCU	5,00 €
	2525-M3X14	2525-M3X14 KARTUŞ SIKMA VİDASI	0,80 €
	2503-M4X12	2503-M4X12 KANAL KATER VİDASI	0,80 €
	2503-M4X15	2503-M4X15 KARTUŞ SIKMA VİDASI	0,80 €
	2503-M4X20	2503-M4X20 KARTUŞ SIKMA VİDASI	0,80 €
	2504-M5X25	2504-M5X25 KARTUŞ SIKMA VİDASI	0,80 €
	2505-M6X30	2505-M6X30 KARTUŞ SIKMA VİDASI	0,80 €
	2306-M8X37	2306-M8X37 MONTAJ VİDASI (KAFASI KÜÇÜK)	0,80 €
	2405-M8X30	A16 MONTAJ VİDASI (KAFASI KÜÇÜK)	0,80 €
	2506-M8X35	2506-M8X35 KARTUŞ SIKMA VİDASI	0,80 €
	2508-M10X40	2508-M10X40 KARTUŞ SIKMA VİDASI	0,80 €
	2510-M12X40	2510-M12X40 KARTUŞ SIKMA VİDASI	0,80 €
	2715-M3X4	2715-M3X4 KARTUŞ ÖLÇÜ AYAR VİDASI	0,50 €
	2715-M3X5	2715-M3X5 KARTUŞ ÖLÇÜ AYAR VİDASI	0,50 €
	2715-M3X8	2715-M3X8 KARTUŞ ÖLÇÜ AYAR VİDASI	0,50 €
	2702-M4X12	2702-M4X12 KARTUŞ ÖLÇÜ AYAR VİDASI	0,50 €
	2725-M5X12	2725-M5X12 KARTUŞ ÖLÇÜ AYAR VİDASI	0,50 €
	2725-M5X14	2725-M5X14 KARTUŞ ÖLÇÜ AYAR VİDASI	0,50 €
	2703-M6X16	2703-M6X16 KARTUŞ ÖLÇÜ AYAR VİDASI	0,50 €
	2704-M8X25	2704-M8X25 KARTUŞ ÖLÇÜ AYAR VİDASI	0,50 €











KANAL KATER VİDALARI

ÜRÜN RESMİ	ÜRÜN KODU	ÜRÜN DETAYI	FİYATI
	AKV-02-M6x20	KANAL KATER VİDASI	0,80 €
	AKV-08-M6X12	C-SİSTEM FREZELEME VİDASI	1,00 €
	AKV-09-M8X18	C-SİSTEM FREZELEME VİDASI	1,00 €
	AKV-29-M6x28	KANAL KATER VİDASI	1,50 €
	2503-M4x10	İMBUS VİDA	0,80 €
	2503-M4x16	İMBUS VİDA	0,80 €
	2504-M5x12	İMBUS VİDA	0,80 €
	2504-M5x16	İMBUS VİDA	0,80 €
	2505-M6x16	İMBUS VİDA	0,80 €
	2505-M6x20	İMBUS VİDA	0,80 €
	2505-M6X25	BLOK BASKI PABUÇ VİDASI	0,80 €
	2004-M8x20	KANAL KATER VİDASI	1,00 €
	2004-M8x1x20	KANAL KATER VİDASI	1,00 €
	1904-M8x1x20	KANAL KATER VİDASI	1,00 €

SIKIŞMAYI ÖNLEYİCİ YAĞ

ÜRÜN RESMİ	ÜRÜN DETAYI	FİYATI
	SIKIŞMAYI ÖNLEYİCİ YAĞ	1,80 €

YEDEK PARÇALAR
SOĞUTUCU HORTUM SETLERİ

SET İÇİNDEKİ PARÇALAR			Liste Fiyatı ad.	Set Kodu : ACHS-1-250	Set Kodu : ACHS-2-250	Set Kodu : ACHS-3-250
Ürün Resmi	Ürün Kodu	Ürün Açıklaması		Uzunluk : 250 mm Fiyat : 18,70 €	Uzunluk : 250 mm Fiyat : 20,90 €	Uzunluk : 250 mm Fiyat : 21,50 €
① 	AMP-01	M10 Bağlantı Elemanı	1,10 €	1 ad.	-	-
② 	AMP-02	G1/8'' Çift Bağlantı Elemanı	2,00 €	2 ad.	1 ad.	-
③ 	AMP-03	G1/8'' Açılı Bağlantısı	1,00 €	-	1 ad.	2 ad.
④ 	AMP-04	M10 Açılı Bağlantısı	1,00 €	-	1 ad.	1 ad.
⑤ 	AMP-05	G1/4''-G1/8'' Kılışma Parçası	1,70 €	-	1 ad.	1 ad.
⑥ 	AG-01	Bakır Conta	0,60 €	2 ad.	3 ad.	4 ad.
⑦ 	2705-G1/8X5.5	G1/8'' Sızdırmaz Cıvata	0,80 €	1 ad.	1 ad.	1 ad.
⑧ 	AH-1-250	Hortum	10,80 €	1 ad.	-	-
⑨ 	AH-2-250	Hortum	12,60 €	-	1 ad.	-
⑩ 	AH-3-250	Hortum	13,60 €	-	-	1 ad.



konusulan
the spoken *kalite...*
quality...



*konusulan
the spoken kalite...
quality...*



***konusulan**
the spoken kalite...
quality...*



α = 5 Kat Dayanıklılık **α = 5 Times Long Life**

Alfa Kaplamanın Avantajları

Alpha Coating Advantages

- **Yüksek aşınma direnci**
High resistance to abrasion
- **Yüksek yüzey sertliği**
750-800 Vickers
High surface hardness
750-800 Vickers
- **Temperlemeye karşı yüksek direnç**
High resistance to tempering
- **Yüksek yorulma mukavemeti**
High fatigue strength
- **Yüksek çizik ve çentik direnci**
High scratch and impact resistance
- **Paslanmaz olmayan çelikler için daha yüksek korozyon direnci**
Resistant to corrosion of non-stainless steel

takımınız neden
daha uzun ömürlü
olmasın?...

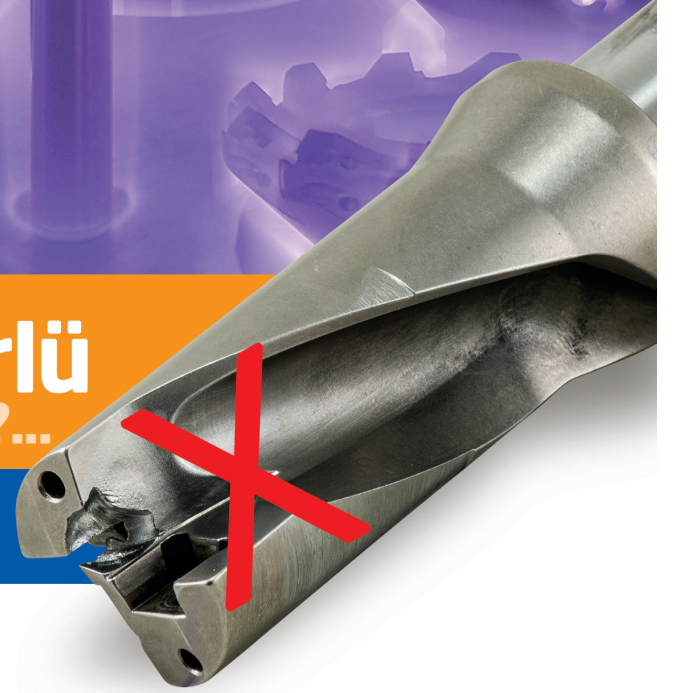
longer tool life... **α Çevre Dostudur. α is friend of environment.****İnsan sağlığı açısından zararlı değildir. Is not harmful to human health.****Gaz ve diğer atıkları çevreyi kirlilemez. Gas and other wastes will not pollute the environment.**



Konya Organize Sanayi Bölgesi
Işıktepe Sk. No:6 P.K. 42250
Selçuklu / KONYA / TÜRKİYE

Tel : +90 332 239 17 57 (pbx)
Fax : +90 332 239 17 52
GPS : 37.973262 N / 32.604158 E

www.akkо.com.tr
akkо@akkо.com.tr
export@akkо.com.tr

